

Indoor | Recessed luminaires | Yori Semi-recessed

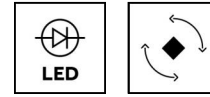

**CUT
OUT**

55mm

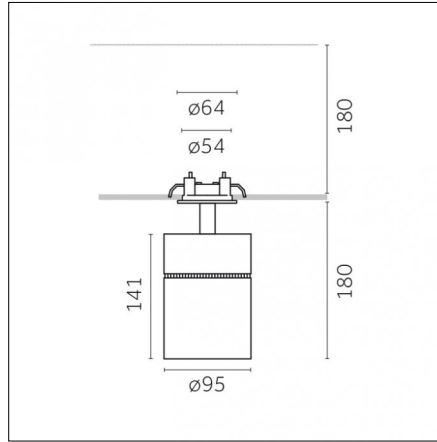

Narrow 12°

12 IP20 III Risk 1 850° NO NO 5 ENE CCC CE CB

Code X.MM33B.HC12

Light source features

Number of light sources: 1

Source type: LED HC

Watt: 12W

Lm: 1323lm

Lm/W: 110lm/W

Kelvin/CRI: 3000K / >98

SDCM/L90 B10: < 2 / 50000

Electrical features

Driver included: NO

Driver type: no driver included

Isolation class: Class III

Optical features

Beam angle: 12°

Optical type, adjustability: Adjustable

Interchangeable optic (IOS): YES

Physical features

Material: Die-cast aluminium

Fixing: Ceiling

Adjustability: 90° horizontal axis 356° vertical axis

Finishing: Embossed matt white (Standard)

Weight: 0.9Kg

Luminaire constructed in conformity with Directives 2014/35/EU (LV), 2014/30/EU (EMC), 2009/125/EC (Ecodesign) with Regulations (EC) No 245/2009, (EU) No 347/2010 and (EU) 2015/1428 (for luminaires with fluorescent and metal halide lamps only), 2009/125/EC (Ecodesign) with Regulations (EU) No 1194/2012 and 2015/1428 (for LED luminaires only), 2011/65/EU (RoHS 2) and 2012/19/EU (WEEE).

Reggiani SPA Illuminazione

Viale Monza, 16 20845 Sovico (MB) Italy
Tel. (+39) 039 2071.1 fax (+39) 039 2071 999

www.reggiani.net
contact@reggiani.net

Photometries



Specifications text

YORI
Track, channel, recessed and surface mounting fixture. Symmetrical output. Available for LED and metal halide lamps. Die-cast aluminium body. Interchangeable IOS Ø 50mm (LL1) and Ø 80mm (LL2) reflectors in polycarbonate stabilised up to 140° with highly reflective metal coating - exclusive anti-scratch treatment with surface vitrification for LED lamps. Interchangeable IOS Ø 80mm reflectors in 99.99% pure aluminium, with bayonet fitting for metal halide lamps. Anti-static polycarbonate protective screen with a high transmission index (97%); transparent for very narrow light beams, satin for narrow, medium and wide beams and satin/prismatic for the Mira version; anti-yellowing, stabilised against UV rays, resistant to 850° incandescent wire test, self-extinguishing V0; tempered protective glass for IOS reflectors for metal halide lamps Spot adjustable 0° to 90° vertically and 356° horizontally; integrated plastic no-glare screen; recessed optics for improved visual comfort; mounts to false ceilings with the innovative ClikFix one-way spring system (for recessed, semi-recessed and surface mounted versions); drilled bezel for fine mortaring with 0.7 mm trimless bezel thickness for perfect plastering (recessed version); special perforated steel panel maximises heat dispersal outwards (recessed version); vertical slide for moving the luminaire outwards (recessed version); grub screw for locking the adjustment (recessed version); mechanical/electrical connector with m/f connectors (channel version); up to 10 units can be connected in line with a single power supply (channel version); articulated boom for orienting the fixture (for coves, false ceiling and surround versions); available as pre-assembled KIT version with 2, 3 and 4 fixtures for channel, surface and trimless mounting. Anti-yellowing epoxy powder coating, stabilised against UV rays. Product available with the following finishes: matt embossed white 12, matt embossed black 31. Passive heat dissipation via optimised fixture casing construction, which uses the heat conductivity of the metal and convective currents. Available with LED ON/OFF driver, DIMM 1-10V, PHASE CUTTING and DALI 220/240V VAC 50/60 Hz. Electronic driver for LED lamps, electronic power supply for metal halide lamps. Driver/power supply included in package. Isolation class II and III. IP20. The product can be equipped with: cross grille, no-glare honeycomb grille and UV, IR, dichroic and selective filters for food applications. Emergency unit (3 hour) available as accessory equipment. Fixture built in compliance with Standard EN 60598-1 and amendments and EC Directives 2006/95/CE (low voltage), 2004/108/CE (EMC), 2009/125/CE (Ecodesign), 2002/96/CE (RAEE), 2011/65/CE (RoHS).

Luminaire constructed in conformity with Directives 2014/35/EU (LV), 2014/30/EU (EMC), 2009/125/EC (Ecodesign) with Regulations (EC) No 245/2009, (EU) No 347/2010 and (EU) 2015/1428 (for luminaires with fluorescent and metal halide lamps only), 2009/125/EC (Ecodesign) with Regulations (EU) No 1194/2012 and 2015/1428 (for LED luminaires only), 2011/65/EU (RoHS 2) and 2012/19/EU (WEEE).

Optics

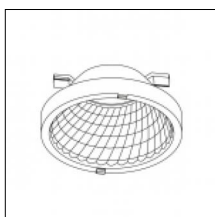

Code 0.35037.0000 - LL7 - Wide beam (38°) - LED

Finishing:
Description:

Wide Wide

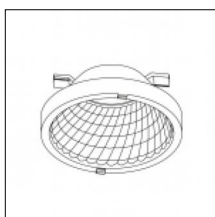

Code 0.35038.0000 - LL7 - Very wide beam (53°) - LED

Finishing:
Description:

Very wide Very wide

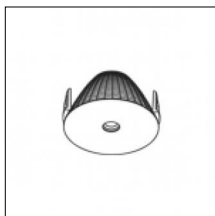

Code 0.35135.0000 - Ø95mm precision optic 12° - LED

Finishing:
Description:



Narrow 12°

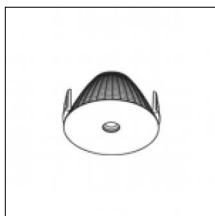

Code 0.35136.0000 - Ø95mm precision optic 24° - LED

Finishing:
Description:



Medium 24°

Driver

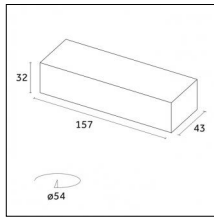

Code 0.30341.0000 - Driver

Type: On-Off
Watt: 25W - AC Input: 220-240Vac - mA:350mA
Description:

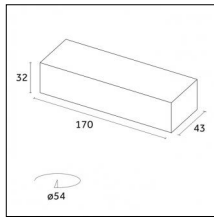

Code D.30341.0000 - Driver

Type: DALI
Watt: 36W - AC Input: 198-264Vac , 170-280Vdc - mA:350mA
Description:

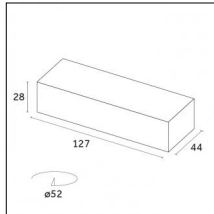

Code T.30412.0000 - Driver Mood

Type: PHASE CUT
Watt: W - AC Input: 220-240Vac - mA:350mA
Description: Connection options: 1
For more information download the dedicated driver board



Code V.30341.0000 - Driver

Type: DIMM 1-10V
Watt: 33W - AC Input: 120-277Vac - mA:350mA
Description:

Accessories

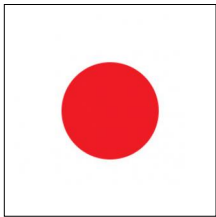

Code 0.26406.004A - Red glass filter 1 mm

Type: Optical
Finishing: Red

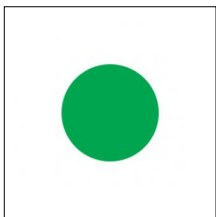

Code 0.26406.005A - Green glass filter 1 mm

Type: Optical
Finishing: Green

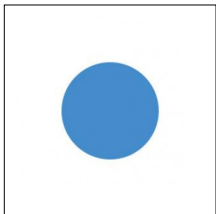

Code 0.26406.006A - Blue glass filter 1 mm

Type: Optical
Finishing: Blue

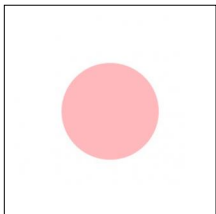

Code 0.26406.007A - Pink glass filter 1 mm

Type: Optical
Finishing: Pink

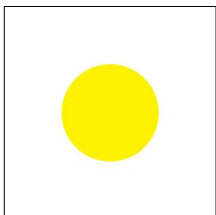

Code 0.26406.008A - Yellow glass filter 1 mm

Type: Optical
Finishing: Yellow

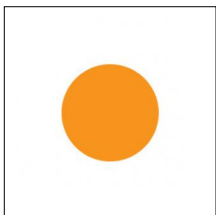

Code 0.26406.009A - Orange glass filter 1 mm

Type: Optical
Finishing: Orange

Accessories



Code 0.26414.0000 - Colored Gel Slides (2 pieces)

Type: Optical
Finishing: Without finish / Stainles Steel / Natural aluminium (Standard)

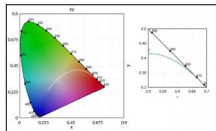
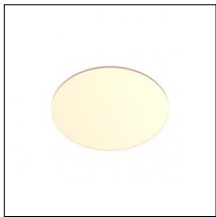

Code 0.26422.0000 - Selective filter 2700K - 2500K

Type: Optical
Finishing: Without finish / Stainles Steel / Natural aluminium (Standard)

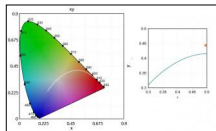
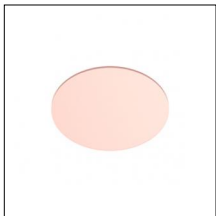

Code 0.26430.0000 - Selective filter 2700K - 2200K

Type: Optical
Finishing: Without finish / Stainles Steel / Natural aluminium (Standard)

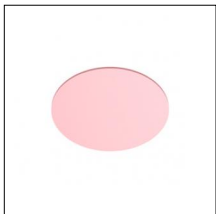

Code 0.26438.0000 - Selective filter 2700K - 2000K

Type: Optical
Finishing: Without finish / Stainles Steel / Natural aluminium (Standard)

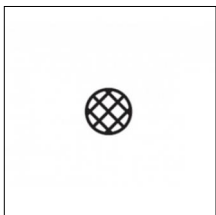

Code 0.26446.0000 - Honeycomb dense texture

Type: Optical
Finishing: Without finish / Stainles Steel / Natural aluminium (Standard)

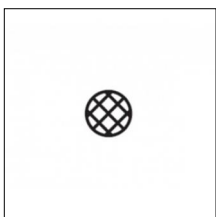

Code 0.26454.0000 - Honeycomb wide texture

Type: Optical
Finishing: Without finish / Stainles Steel / Natural aluminium (Standard)

Accessories

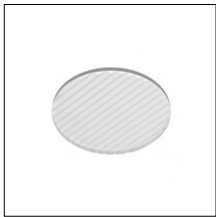

Code 0.26459.0000 - Ribbed glass

Type: Optical

Finishing: Without finish / Stainles Steel / Natural aluminium (Standard)

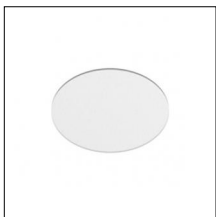

Code 0.26466.0000 - Opal lens

Type: Optical

Finishing: Without finish / Stainles Steel / Natural aluminium (Standard)

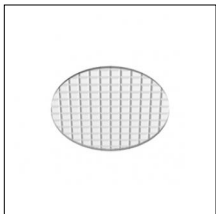

Code 0.26474.0000 - Diffusive lens

Type: Optical

Finishing: Without finish / Stainles Steel / Natural aluminium (Standard)

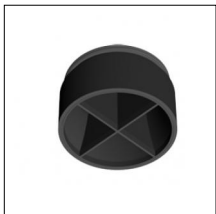

Code 0.26479.0000 - Cross blade louver

Type: Optical

Finishing: Without finish / Stainles Steel / Natural aluminium (Standard)

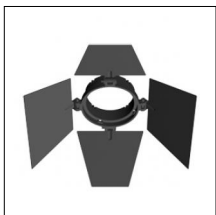

Code 0.26487.0000 - Barn doors

Type: Optical

Finishing: Without finish / Stainles Steel / Natural aluminium (Standard)



Code 0.26491.0012 - Cone 45 ° wall washer

Type: Optical

Finishing: Embossed matt white (Standard)

Accessories



Code 0.26491.0031 - Cone 45 ° wall washer

Type: Optical
Finishing: Embossed matt black (Standard)

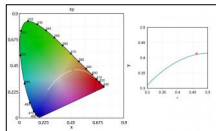
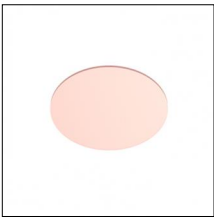

Code 0.26563.0000 - Selective filter 3000K-2700K

Type: Optical
Finishing: Without finish / Stainles Steel / Natural aluminium (Standard)

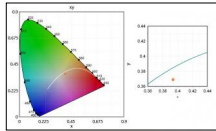
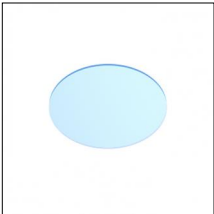

Code 0.26571.0000 - Selective filter 3000K-3600K

Type: Optical
Finishing: Without finish / Stainles Steel / Natural aluminium (Standard)

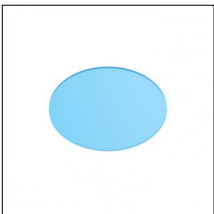

Code 0.26579.0000 - Selective filter 3000K-4000K

Type: Optical
Finishing: Without finish / Stainles Steel / Natural aluminium (Standard)

Indoor | Recessed luminaires | Yori Semi-recessed

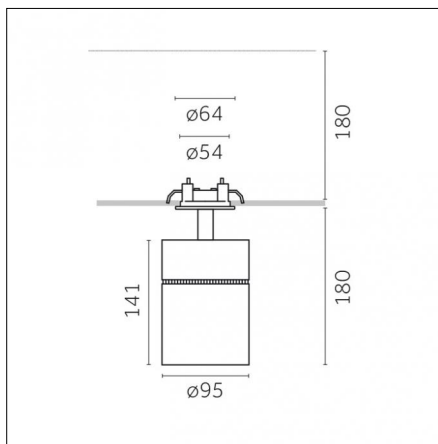

**CUT
OUT**

55mm



Medium 24°

12

IP20



Risk 1

850°



Code X.MM33E.HW12

Light source features

Number of light sources: 1

Source type: LED HW

Watt: 12W

Lm: 1491lm

Lm/W: 124lm/W

Kelvin/CRI: 2700K / >90

SDCM/L90 B10: < 2 / 50000

Electrical features

Driver included: NO

Driver type: no driver included

Isolation class: Class III

Optical features

Beam angle: 24°

Optical type, adjustability: Adjustable

Interchangeable optic (IOS): YES

Physical features

Material: Die-cast aluminium

Fixing: Ceiling

Adjustability: 90° horizontal axis 356° vertical axis

Finishing: Embossed matt white (Standard)

Weight: 0.9Kg

Luminaire constructed in conformity with Directives 2014/35/EU (LV), 2014/30/EU (EMC), 2009/125/EC (Ecodesign) with Regulations (EC) No 245/2009, (EU) No 347/2010 and (EU) 2015/1428 (for luminaires with fluorescent and metal halide lamps only), 2009/125/EC (Ecodesign) with Regulations (EU) No 1194/2012 and 2015/1428 (for LED luminaires only), 2011/65/EU (RoHS 2) and 2012/19/EU (WEEE).

Reggiani SPA Illuminazione

Viale Monza, 16 20845 Sovico (MB) Italy
Tel. (+39) 039 2071.1 fax (+39) 039 2071 999

www.reggiani.net
contact@reggiani.net

Photometries



Specifications text

YORI
Track, channel, recessed and surface mounting fixture. Symmetrical output. Available for LED and metal halide lamps. Die-cast aluminium body. Interchangeable IOS Ø 50mm (LL1) and Ø 80mm (LL2) reflectors in polycarbonate stabilised up to 140° with highly reflective metal coating - exclusive anti-scratch treatment with surface vitrification for LED lamps. Interchangeable IOS Ø 80mm reflectors in 99.99% pure aluminium, with bayonet fitting for metal halide lamps. Anti-static polycarbonate protective screen with a high transmission index (97%); transparent for very narrow light beams, satin for narrow, medium and wide beams and satin/prismatic for the Mira version; anti-yellowing, stabilised against UV rays, resistant to 850° incandescent wire test, self-extinguishing V0; tempered protective glass for IOS reflectors for metal halide lamps Spot adjustable 0° to 90° vertically and 356° horizontally; integrated plastic no-glare screen; recessed optics for improved visual comfort; mounts to false ceilings with the innovative ClikFix one-way spring system (for recessed, semi-recessed and surface mounted versions); drilled bezel for fine mortaring with 0.7 mm trimless bezel thickness for perfect plastering (recessed version); special perforated steel panel maximises heat dispersal outwards (recessed version); vertical slide for moving the luminaire outwards (recessed version); grub screw for locking the adjustment (recessed version); mechanical/electrical connector with m/f connectors (channel version); up to 10 units can be connected in line with a single power supply (channel version); articulated boom for orienting the fixture (for coves, false ceiling and surround versions); available as pre-assembled KIT version with 2, 3 and 4 fixtures for channel, surface and trimless mounting. Anti-yellowing epoxy powder coating, stabilised against UV rays. Product available with the following finishes: matt embossed white 12, matt embossed black 31. Passive heat dissipation via optimised fixture casing construction, which uses the heat conductivity of the metal and convective currents. Available with LED ON/OFF driver, DIMM 1-10V, PHASE CUTTING and DALI 220/240V VAC 50/60 Hz. Electronic driver for LED lamps, electronic power supply for metal halide lamps. Driver/power supply included in package. Isolation class II and III. IP20. The product can be equipped with: cross grille, no-glare honeycomb grille and UV, IR, dichroic and selective filters for food applications. Emergency unit (3 hour) available as accessory equipment. Fixture built in compliance with Standard EN 60598-1 and amendments and EC Directives 2006/95/CE (low voltage), 2004/108/CE (EMC), 2009/125/CE (Ecodesign), 2002/96/CE (RAEE), 2011/65/CE (RoHS).

Luminaire constructed in conformity with Directives 2014/35/EU (LV), 2014/30/EU (EMC), 2009/125/EC (Ecodesign) with Regulations (EC) No 245/2009, (EU) No 347/2010 and (EU) 2015/1428 (for luminaires with fluorescent and metal halide lamps only), 2009/125/EC (Ecodesign) with Regulations (EU) No 1194/2012 and 2015/1428 (for LED luminaires only), 2011/65/EU (RoHS 2) and 2012/19/EU (WEEE).

Optics

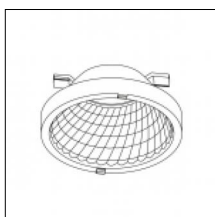

Code 0.35037.0000 - LL7 - Wide beam (38°) - LED

Finishing:
Description:

Wide Wide

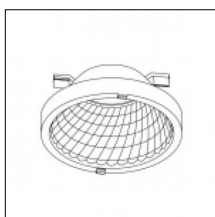

Code 0.35038.0000 - LL7 - Very wide beam (53°) - LED

Finishing:
Description:

Very wide Very wide

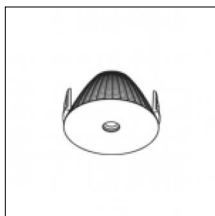

Code 0.35135.0000 - Ø95mm precision optic 12° - LED

Finishing:
Description:



Narrow 12°

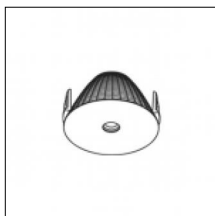

Code 0.35136.0000 - Ø95mm precision optic 24° - LED

Finishing:
Description:



Medium 24°

Driver

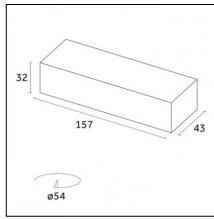

Code 0.30341.0000 - Driver

Type: On-Off
Watt: 25W - AC Input: 220-240Vac - mA:350mA
Description:

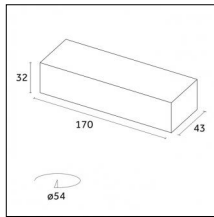

Code D.30341.0000 - Driver

Type: DALI
Watt: 36W - AC Input: 198-264Vac , 170-280Vdc - mA:350mA
Description:

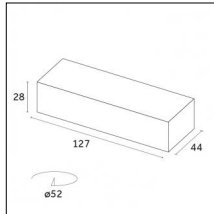

Code T.30412.0000 - Driver Mood

Type: PHASE CUT
Watt: W - AC Input: 220-240Vac - mA:350mA
Description: Connection options: 1
For more information download the dedicated driver board



Code V.30341.0000 - Driver

Type: DIMM 1-10V
Watt: 33W - AC Input: 120-277Vac - mA:350mA
Description:

Accessories

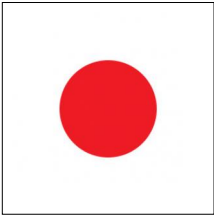

Code 0.26406.004A - Red glass filter 1 mm

Type: Optical
Finishing: Red

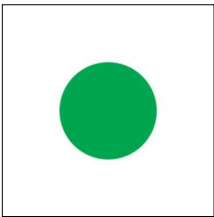

Code 0.26406.005A - Green glass filter 1 mm

Type: Optical
Finishing: Green

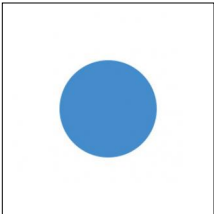

Code 0.26406.006A - Blue glass filter 1 mm

Type: Optical
Finishing: Blue

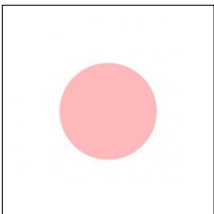

Code 0.26406.007A - Pink glass filter 1 mm

Type: Optical
Finishing: Pink

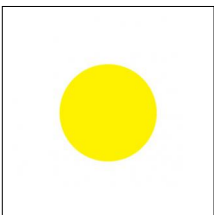

Code 0.26406.008A - Yellow glass filter 1 mm

Type: Optical
Finishing: Yellow

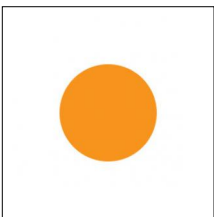

Code 0.26406.009A - Orange glass filter 1 mm

Type: Optical
Finishing: Orange

Accessories



Code 0.26414.0000 - Colored Gel Slides (2 pieces)

Type: Optical
Finishing: Without finish / Stainles Steel / Natural aluminium (Standard)

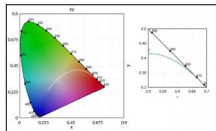
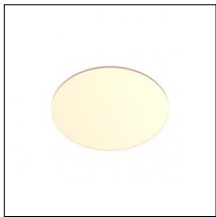

Code 0.26422.0000 - Selective filter 2700K - 2500K

Type: Optical
Finishing: Without finish / Stainles Steel / Natural aluminium (Standard)

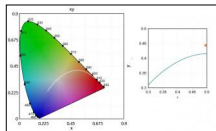
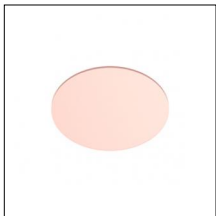

Code 0.26430.0000 - Selective filter 2700K - 2200K

Type: Optical
Finishing: Without finish / Stainles Steel / Natural aluminium (Standard)

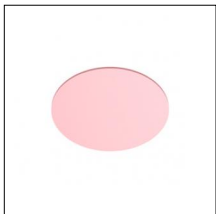

Code 0.26438.0000 - Selective filter 2700K - 2000K

Type: Optical
Finishing: Without finish / Stainles Steel / Natural aluminium (Standard)

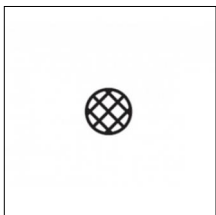

Code 0.26446.0000 - Honeycomb dense texture

Type: Optical
Finishing: Without finish / Stainles Steel / Natural aluminium (Standard)

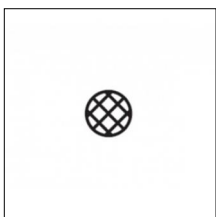

Code 0.26454.0000 - Honeycomb wide texture

Type: Optical
Finishing: Without finish / Stainles Steel / Natural aluminium (Standard)

Accessories

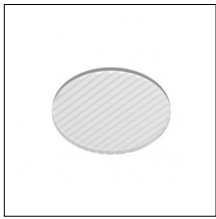

Code 0.26459.0000 - Ribbed glass

Type: Optical

Finishing: Without finish / Stainles Steel / Natural aluminium (Standard)

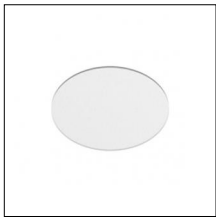

Code 0.26466.0000 - Opal lens

Type: Optical

Finishing: Without finish / Stainles Steel / Natural aluminium (Standard)

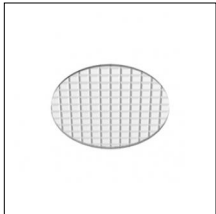

Code 0.26474.0000 - Diffusive lens

Type: Optical

Finishing: Without finish / Stainles Steel / Natural aluminium (Standard)

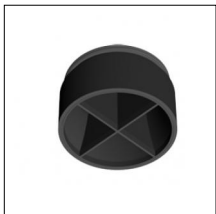

Code 0.26479.0000 - Cross blade louvre

Type: Optical

Finishing: Without finish / Stainles Steel / Natural aluminium (Standard)

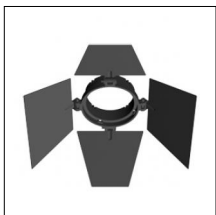

Code 0.26487.0000 - Barn doors

Type: Optical

Finishing: Without finish / Stainles Steel / Natural aluminium (Standard)



Code 0.26491.0012 - Cone 45 ° wall washer

Type: Optical

Finishing: Embossed matt white (Standard)

Accessories



Code 0.26491.0031 - Cone 45 ° wall washer

Type: Optical
Finishing: Embossed matt black (Standard)

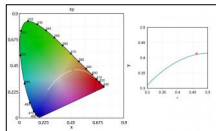
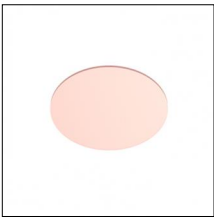

Code 0.26563.0000 - Selective filter 3000K-2700K

Type: Optical
Finishing: Without finish / Stainles Steel / Natural aluminium (Standard)

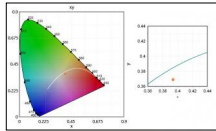
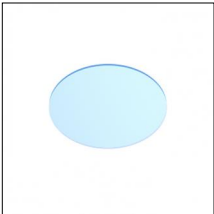

Code 0.26571.0000 - Selective filter 3000K-3600K

Type: Optical
Finishing: Without finish / Stainles Steel / Natural aluminium (Standard)

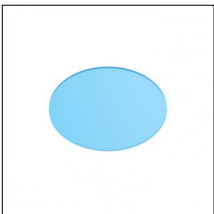

Code 0.26579.0000 - Selective filter 3000K-4000K

Type: Optical
Finishing: Without finish / Stainles Steel / Natural aluminium (Standard)

Indoor | Recessed luminaires | Yori Semi-recessed

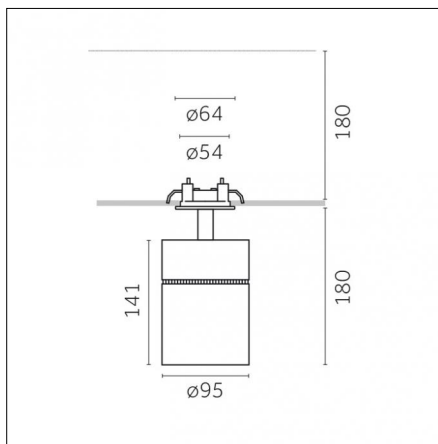

**CUT
OUT**

55mm



Very narrow 7°

12

IP20



Risk 1

850°



Code X.QM34A.HC12

Light source features

Number of light sources: 1

Source type: LED HC

Watt: 17W

Lm: 1834lm

Lm/W: 108lm/W

Kelvin/CRI: 3000K / >98

SDCM/L90 B10: < 2 / 50000

Electrical features

Driver included: NO

Driver type: no driver included

Isolation class: Class III

Optical features

Beam angle: 7°

Optical type, adjustability: Adjustable

Interchangeable optic (IOS): YES

Physical features

Material: Die-cast aluminium

Fixing: Ceiling

Adjustability: 90° horizontal axis 356° vertical axis

Finishing: Embossed matt white (Standard)

Weight: 0.9Kg

Luminaire constructed in conformity with Directives 2014/35/EU (LV), 2014/30/EU (EMC), 2009/125/EC (Ecodesign) with Regulations (EC) No 245/2009, (EU) No 347/2010 and (EU) 2015/1428 (for luminaires with fluorescent and metal halide lamps only), 2009/125/EC (Ecodesign) with Regulations (EU) No 1194/2012 and 2015/1428 (for LED luminaires only), 2011/65/EU (RoHS 2) and 2012/19/EU (WEEE).

Reggiani SPA Illuminazione

Viale Monza, 16 20845 Sovico (MB) Italy
Tel. (+39) 039 2071.1 fax (+39) 039 2071 999

www.reggiani.net
contact@reggiani.net

Photometries



Specifications text

YORI
Track, channel, recessed and surface mounting fixture. Symmetrical output. Available for LED and metal halide lamps. Die-cast aluminium body. Interchangeable IOS Ø 50mm (LL1) and Ø 80mm (LL2) reflectors in polycarbonate stabilised up to 140° with highly reflective metal coating - exclusive anti-scratch treatment with surface vitrification for LED lamps. Interchangeable IOS Ø 80mm reflectors in 99.99% pure aluminium, with bayonet fitting for metal halide lamps. Anti-static polycarbonate protective screen with a high transmission index (97%); transparent for very narrow light beams, satin for narrow, medium and wide beams and satin/prismatic for the Mira version; anti-yellowing, stabilised against UV rays, resistant to 850° incandescent wire test, self-extinguishing V0; tempered protective glass for IOS reflectors for metal halide lamps Spot adjustable 0° to 90° vertically and 356° horizontally; integrated plastic no-glare screen; recessed optics for improved visual comfort; mounts to false ceilings with the innovative ClikFix one-way spring system (for recessed, semi-recessed and surface mounted versions); drilled bezel for fine mortaring with 0.7 mm trimless bezel thickness for perfect plastering (recessed version); special perforated steel panel maximises heat dispersal outwards (recessed version); vertical slide for moving the luminaire outwards (recessed version); grub screw for locking the adjustment (recessed version); mechanical/electrical connector with m/f connectors (channel version); up to 10 units can be connected in line with a single power supply (channel version); articulated boom for orienting the fixture (for coves, false ceiling and surround versions); available as pre-assembled KIT version with 2, 3 and 4 fixtures for channel, surface and trimless mounting. Anti-yellowing epoxy powder coating, stabilised against UV rays. Product available with the following finishes: matt embossed white 12, matt embossed black 31. Passive heat dissipation via optimised fixture casing construction, which uses the heat conductivity of the metal and convective currents. Available with LED ON/OFF driver, DIMM 1-10V, PHASE CUTTING and DALI 220/240V VAC 50/60 Hz. Electronic driver for LED lamps, electronic power supply for metal halide lamps. Driver/power supply included in package. Isolation class II and III. IP20. The product can be equipped with: cross grille, no-glare honeycomb grille and UV, IR, dichroic and selective filters for food applications. Emergency unit (3 hour) available as accessory equipment. Fixture built in compliance with Standard EN 60598-1 and amendments and EC Directives 2006/95/CE (low voltage), 2004/108/CE (EMC), 2009/125/CE (Ecodesign), 2002/96/CE (RAEE), 2011/65/CE (RoHS).

Luminaire constructed in conformity with Directives 2014/35/EU (LV), 2014/30/EU (EMC), 2009/125/EC (Ecodesign) with Regulations (EC) No 245/2009, (EU) No 347/2010 and (EU) 2015/1428 (for luminaires with fluorescent and metal halide lamps only), 2009/125/EC (Ecodesign) with Regulations (EU) No 1194/2012 and 2015/1428 (for LED luminaires only), 2011/65/EU (RoHS 2) and 2012/19/EU (WEEE).

Optics

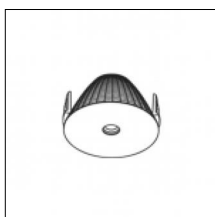

Code 0.35135.0000 - Ø95mm precision optic 12° - LED

Finishing:
Description:



Narrow 12°

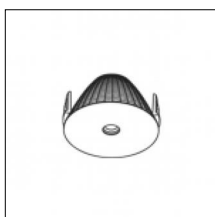

Code 0.35136.0000 - Ø95mm precision optic 24° - LED

Finishing:
Description:



Medium 24°

Driver

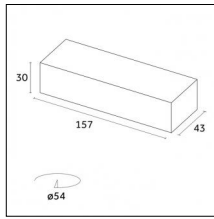

Code 0.30342.0000 - Driver

Type: On-Off
Watt: 25W - AC Input: 220-240Vac - mA:500mA
Description:

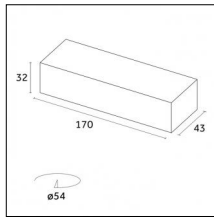

Code D.30342.0000 - Driver

Type: DALI
Watt: 36W - AC Input: 198-264Vac, 170-280Vdc - mA:500mA
Description:

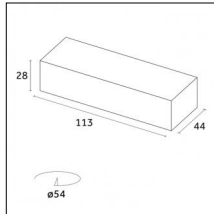

Code T.30342.0000 - Driver

Type: PHASE CUT
Watt: 22W - AC Input: 220-240Vac - mA:500mA
Description:



Code V.30342.0000 - Driver

Type: DIMM 1-10V
Watt: 33W - AC Input: 120-277Vac - mA:500mA
Description:

Accessories

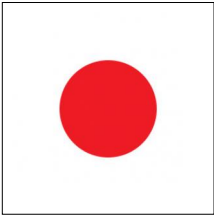

Code 0.26406.004A - Red glass filter 1 mm

Type: Optical
Finishing: Red

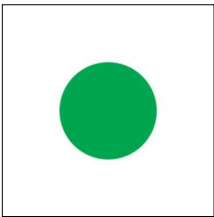

Code 0.26406.005A - Green glass filter 1 mm

Type: Optical
Finishing: Green

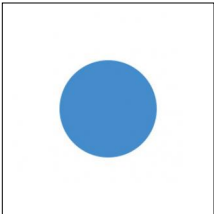

Code 0.26406.006A - Blue glass filter 1 mm

Type: Optical
Finishing: Blue

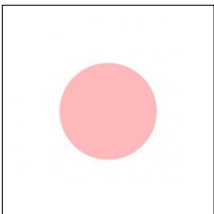

Code 0.26406.007A - Pink glass filter 1 mm

Type: Optical
Finishing: Pink

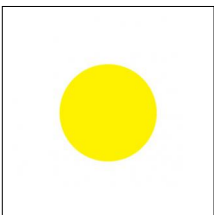

Code 0.26406.008A - Yellow glass filter 1 mm

Type: Optical
Finishing: Yellow

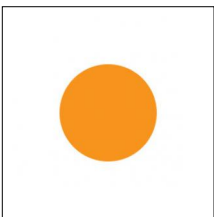

Code 0.26406.009A - Orange glass filter 1 mm

Type: Optical
Finishing: Orange

Accessories



Code 0.26414.0000 - Colored Gel Slides (2 pieces)

Type: Optical
Finishing: Without finish / Stainles Steel / Natural aluminium (Standard)

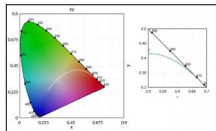
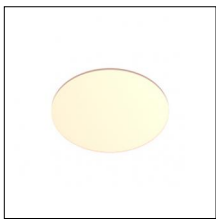

Code 0.26422.0000 - Selective filter 2700K - 2500K

Type: Optical
Finishing: Without finish / Stainles Steel / Natural aluminium (Standard)

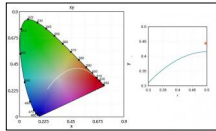
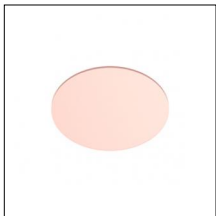

Code 0.26430.0000 - Selective filter 2700K - 2200K

Type: Optical
Finishing: Without finish / Stainles Steel / Natural aluminium (Standard)

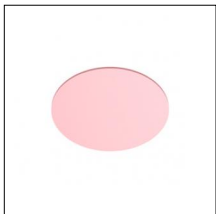

Code 0.26438.0000 - Selective filter 2700K - 2000K

Type: Optical
Finishing: Without finish / Stainles Steel / Natural aluminium (Standard)

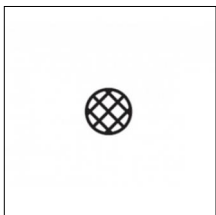

Code 0.26446.0000 - Honeycomb dense texture

Type: Optical
Finishing: Without finish / Stainles Steel / Natural aluminium (Standard)

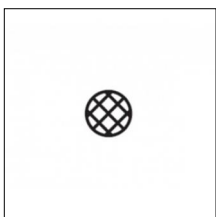

Code 0.26454.0000 - Honeycomb wide texture

Type: Optical
Finishing: Without finish / Stainles Steel / Natural aluminium (Standard)

Accessories

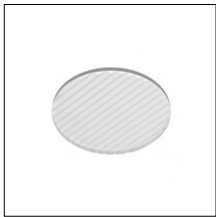

Code 0.26459.0000 - Ribbed glass

Type: Optical

Finishing: Without finish / Stainles Steel / Natural aluminium (Standard)

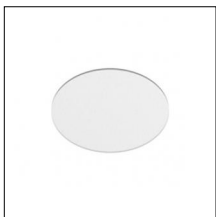

Code 0.26466.0000 - Opal lens

Type: Optical

Finishing: Without finish / Stainles Steel / Natural aluminium (Standard)

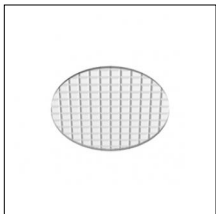

Code 0.26474.0000 - Diffusive lens

Type: Optical

Finishing: Without finish / Stainles Steel / Natural aluminium (Standard)

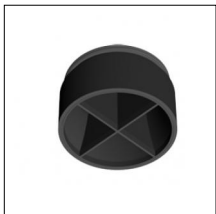

Code 0.26479.0000 - Cross blade louvre

Type: Optical

Finishing: Without finish / Stainles Steel / Natural aluminium (Standard)

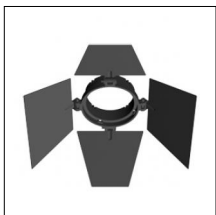

Code 0.26487.0000 - Barn doors

Type: Optical

Finishing: Without finish / Stainles Steel / Natural aluminium (Standard)



Code 0.26491.0012 - Cone 45 ° wall washer

Type: Optical

Finishing: Embossed matt white (Standard)

Accessories



Code 0.26491.0031 - Cone 45 ° wall washer

Type: Optical
Finishing: Embossed matt black (Standard)

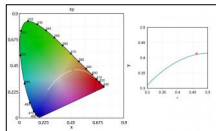
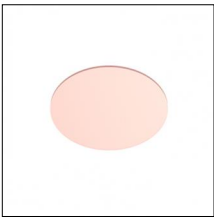

Code 0.26563.0000 - Selective filter 3000K-2700K

Type: Optical
Finishing: Without finish / Stainles Steel / Natural aluminium (Standard)

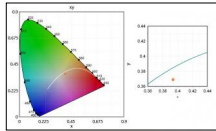
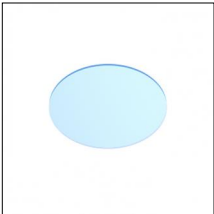

Code 0.26571.0000 - Selective filter 3000K-3600K

Type: Optical
Finishing: Without finish / Stainles Steel / Natural aluminium (Standard)

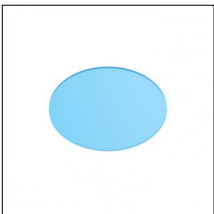

Code 0.26579.0000 - Selective filter 3000K-4000K

Type: Optical
Finishing: Without finish / Stainles Steel / Natural aluminium (Standard)

Indoor | Recessed luminaires | Yori Semi-recessed

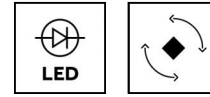
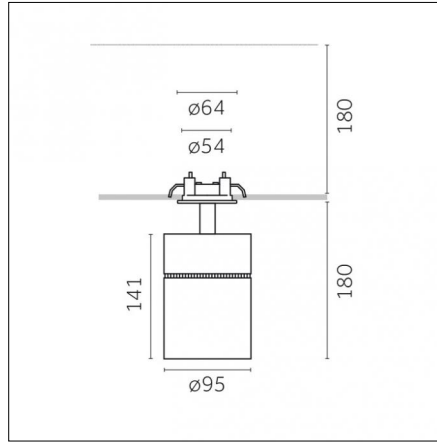

**CUT
OUT**

55mm

Product no optic
included

12 IP20 III Risk 1 850° NO NO 5 ENEC CCC CE CB

Code X.MM38K.NN12

Light source features

Number of light sources: 1

Source type: LED NN

Watt: 33W

Lm: 4695lm

Lm/W: 142lm/W

Kelvin/CRI: 4000K / >80

SDCM/L90 B10: < 3 / 50000

Electrical features

Driver included: NO

Driver type: no driver included

Isolation class: Class III

Optical features

Beam angle: no optic included

Optical type, adjustability: Adjustable

Interchangeable optic (IOS): YES

Physical features

Material: Die-cast aluminium

Fixing: Ceiling

Adjustability: 90° horizontal axis 356° vertical axis

Finishing: Embossed matt white (Standard)

Weight: 0.9Kg

Luminaire constructed in conformity with Directives 2014/35/EU (LV), 2014/30/EU (EMC), 2009/125/EC (Ecodesign) with Regulations (EC) No 245/2009, (EU) No 347/2010 and (EU) 2015/1428 (for luminaires with fluorescent and metal halide lamps only), 2009/125/EC (Ecodesign) with Regulations (EU) No 1194/2012 and 2015/1428 (for LED luminaires only), 2011/65/EU (RoHS 2) and 2012/19/EU (WEEE).

Reggiani SPA Illuminazione

Viale Monza, 16 20845 Sovico (MB) Italy
Tel. (+39) 039 2071.1 fax (+39) 039 2071 999

www.reggiani.net
contact@reggiani.net

Photometries



Specifications text

YORI
Track, channel, recessed and surface mounting fixture. Symmetrical output. Available for LED and metal halide lamps. Die-cast aluminium body. Interchangeable IOS Ø 50mm (LL1) and Ø 80mm (LL2) reflectors in polycarbonate stabilised up to 140° with highly reflective metal coating - exclusive anti-scratch treatment with surface vitrification for LED lamps. Interchangeable IOS Ø 80mm reflectors in 99.99% pure aluminium, with bayonet fitting for metal halide lamps. Anti-static polycarbonate protective screen with a high transmission index (97%); transparent for very narrow light beams, satin for narrow, medium and wide beams and satin/prismatic for the Mira version; anti-yellowing, stabilised against UV rays, resistant to 850° incandescent wire test, self-extinguishing V0; tempered protective glass for IOS reflectors for metal halide lamps Spot adjustable 0° to 90° vertically and 356° horizontally; integrated plastic no-glare screen; recessed optics for improved visual comfort; mounts to false ceilings with the innovative KlikFix one-way spring system (for recessed, semi-recessed and surface mounted versions); drilled bezel for fine mortaring with 0.7 mm trimless bezel thickness for perfect plastering (recessed version); special perforated steel panel maximises heat dispersal outwards (recessed version); vertical slide for moving the luminaire outwards (recessed version); grub screw for locking the adjustment (recessed version); mechanical/electrical connector with m/f connectors (channel version); up to 10 units can be connected in line with a single power supply (channel version); articulated boom for orienting the fixture (for coves, false ceiling and surround versions); available as pre-assembled KIT version with 2, 3 and 4 fixtures for channel, surface and trimless mounting. Anti-yellowing epoxy powder coating, stabilised against UV rays. Product available with the following finishes: matt embossed white 12, matt embossed black 31. Passive heat dissipation via optimised fixture casing construction, which uses the heat conductivity of the metal and convective currents. Available with LED ON/OFF driver, DIMM 1-10V, PHASE CUTTING and DALI 220/240V VAC 50/60 Hz. Electronic driver for LED lamps, electronic power supply for metal halide lamps. Driver/power supply included in package. Isolation class II and III. IP20. The product can be equipped with: cross grille, no-glare honeycomb grille and UV, IR, dichroic and selective filters for food applications. Emergency unit (3 hour) available as accessory equipment. Fixture built in compliance with Standard EN 60598-1 and amendments and EC Directives 2006/95/CE (low voltage), 2004/108/CE (EMC), 2009/125/CE (Ecodesign), 2002/96/CE (RAEE), 2011/65/CE (RoHS).

Luminaire constructed in conformity with Directives 2014/35/EU (LV), 2014/30/EU (EMC), 2009/125/EC (Ecodesign) with Regulations (EC) No 245/2009, (EU) No 347/2010 and (EU) 2015/1428 (for luminaires with fluorescent and metal halide lamps only), 2009/125/EC (Ecodesign) with Regulations (EU) No 1194/2012 and 2015/1428 (for LED luminaires only), 2011/65/EU (RoHS 2) and 2012/19/EU (WEEE).

Optics

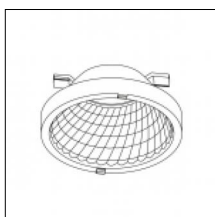

Code 0.35037.0000 - LL7 - Wide beam (38°) - LED

Finishing:
Description:

Wide Wide

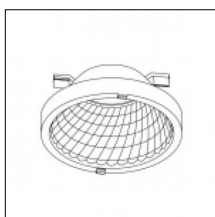

Code 0.35038.0000 - LL7 - Very wide beam (53°) - LED

Finishing:
Description:

Very wide Very wide

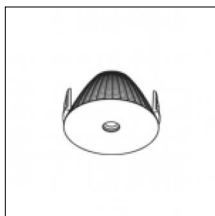

Code 0.35135.0000 - Ø95mm precision optic 12° - LED

Finishing:
Description:



Narrow 12°

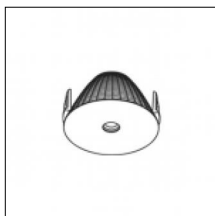

Code 0.35136.0000 - Ø95mm precision optic 24° - LED

Finishing:
Description:



Medium 24°

Driver

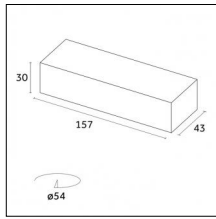

Code 0.30346.0000 - Driver

Type: On-Off
Watt: 40W - AC Input: 220-240Vac - mA:950mA
Description:

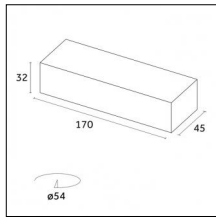

Code D.30346.0000 - Driver Mood

Type: DALI
Watt: 36W - AC Input: 198-264VaC, 170-280VdC - mA:950mA
Description:

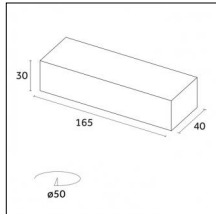

Code T.30346.0000 - Driver

Type: PHASE CUT
Watt: 38W - AC Input: 220-240Vac - mA:950mA
Description:

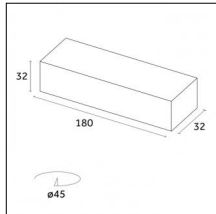

Code V.30346.0000 - Driver

Type: PHASE CUT
Watt: 33W - AC Input: 122-277Vac - mA:950mA
Description:

Accessories

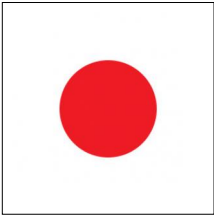

Code 0.26406.004A - Red glass filter 1 mm

Type: Optical
Finishing: Red

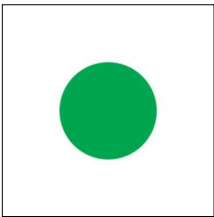

Code 0.26406.005A - Green glass filter 1 mm

Type: Optical
Finishing: Green

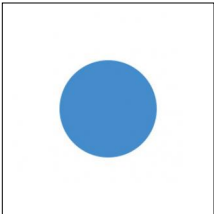

Code 0.26406.006A - Blue glass filter 1 mm

Type: Optical
Finishing: Blue

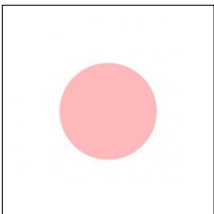

Code 0.26406.007A - Pink glass filter 1 mm

Type: Optical
Finishing: Pink

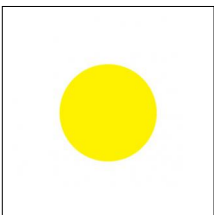

Code 0.26406.008A - Yellow glass filter 1 mm

Type: Optical
Finishing: Yellow

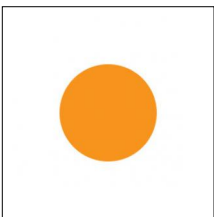

Code 0.26406.009A - Orange glass filter 1 mm

Type: Optical
Finishing: Orange

Accessories



Code 0.26414.0000 - Colored Gel Slides (2 pieces)

Type: Optical
Finishing: Without finish / Stainles Steel / Natural aluminium (Standard)

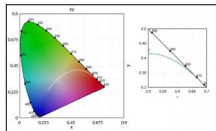
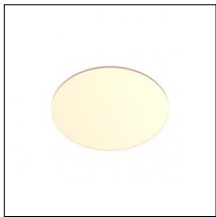

Code 0.26422.0000 - Selective filter 2700K - 2500K

Type: Optical
Finishing: Without finish / Stainles Steel / Natural aluminium (Standard)

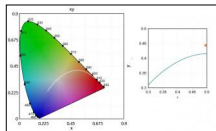
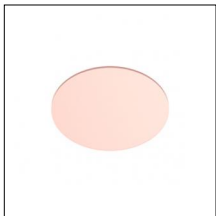

Code 0.26430.0000 - Selective filter 2700K - 2200K

Type: Optical
Finishing: Without finish / Stainles Steel / Natural aluminium (Standard)

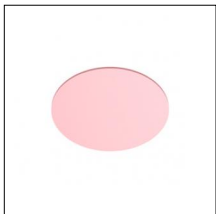

Code 0.26438.0000 - Selective filter 2700K - 2000K

Type: Optical
Finishing: Without finish / Stainles Steel / Natural aluminium (Standard)

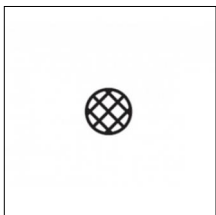

Code 0.26446.0000 - Honeycomb dense texture

Type: Optical
Finishing: Without finish / Stainles Steel / Natural aluminium (Standard)

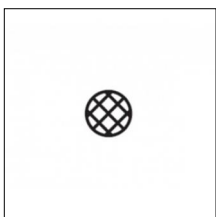

Code 0.26454.0000 - Honeycomb wide texture

Type: Optical
Finishing: Without finish / Stainles Steel / Natural aluminium (Standard)

Accessories

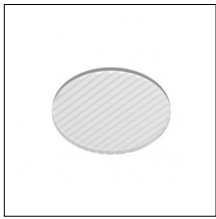

Code 0.26459.0000 - Ribbed glass

Type: Optical

Finishing: Without finish / Stainles Steel / Natural aluminium (Standard)

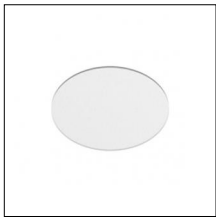

Code 0.26466.0000 - Opal lens

Type: Optical

Finishing: Without finish / Stainles Steel / Natural aluminium (Standard)

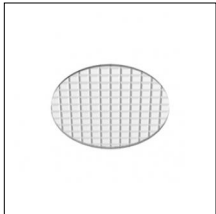

Code 0.26474.0000 - Diffusive lens

Type: Optical

Finishing: Without finish / Stainles Steel / Natural aluminium (Standard)

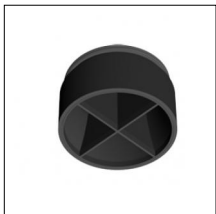

Code 0.26479.0000 - Cross blade louver

Type: Optical

Finishing: Without finish / Stainles Steel / Natural aluminium (Standard)

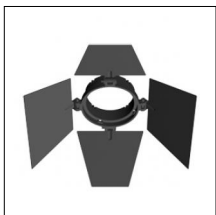

Code 0.26487.0000 - Barn doors

Type: Optical

Finishing: Without finish / Stainles Steel / Natural aluminium (Standard)



Code 0.26491.0012 - Cone 45 ° wall washer

Type: Optical

Finishing: Embossed matt white (Standard)

Accessories



Code 0.26491.0031 - Cone 45 ° wall washer

Type: Optical
Finishing: Embossed matt black (Standard)

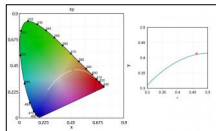
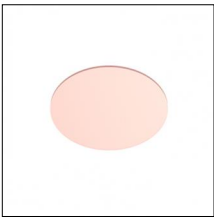

Code 0.26563.0000 - Selective filter 3000K-2700K

Type: Optical
Finishing: Without finish / Stainles Steel / Natural aluminium (Standard)

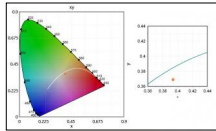
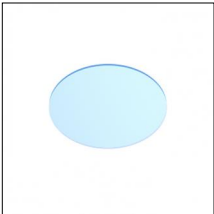

Code 0.26571.0000 - Selective filter 3000K-3600K

Type: Optical
Finishing: Without finish / Stainles Steel / Natural aluminium (Standard)

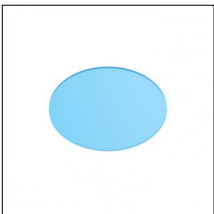

Code 0.26579.0000 - Selective filter 3000K-4000K

Type: Optical
Finishing: Without finish / Stainles Steel / Natural aluminium (Standard)

Indoor | Recessed luminaires | Yori Semi-recessed

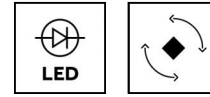
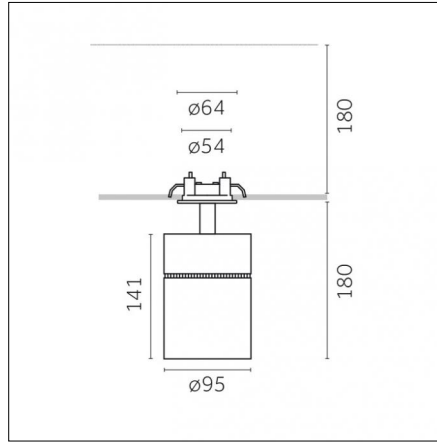

**CUT
OUT**

55mm



Very narrow 10°

12

IP20

III

Risk 1

850°

NO



5

EAC

CCC

CE

CB

Code X.MM43B.HC12

Light source features

Number of light sources: 1

Source type: LED HC

Watt: 12W

Lm: 1323lm

Lm/W: 110lm/W

Kelvin/CRI: 3000K / >98

SDCM/L90 B10: < 2 / 50000

Electrical features

Driver included: NO

Driver type: no driver included

Isolation class: Class III

Optical features

Beam angle: 10°

Optical type, adjustability: Adjustable

Interchangeable optic (IOS): YES

Physical features

Material: Die-cast aluminium

Fixing: Ceiling

Adjustability: 90° horizontal axis 356° vertical axis

Finishing: Embossed matt white (Standard)

Weight: 0.9Kg

Luminaire constructed in conformity with Directives 2014/35/EU (LV), 2014/30/EU (EMC), 2009/125/EC (Ecodesign) with Regulations (EC) No 245/2009, (EU) No 347/2010 and (EU) 2015/1428 (for luminaires with fluorescent and metal halide lamps only), 2009/125/EC (Ecodesign) with Regulations (EU) No 1194/2012 and 2015/1428 (for LED luminaires only), 2011/65/EU (RoHS 2) and 2012/19/EU (WEEE).

Reggiani SPA Illuminazione

Viale Monza, 16 20845 Sovico (MB) Italy
Tel. (+39) 039 2071.1 fax (+39) 039 2071 999

www.reggiani.net
contact@reggiani.net

Photometries

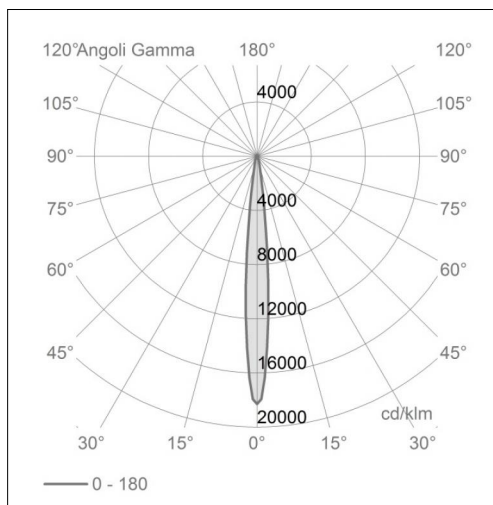
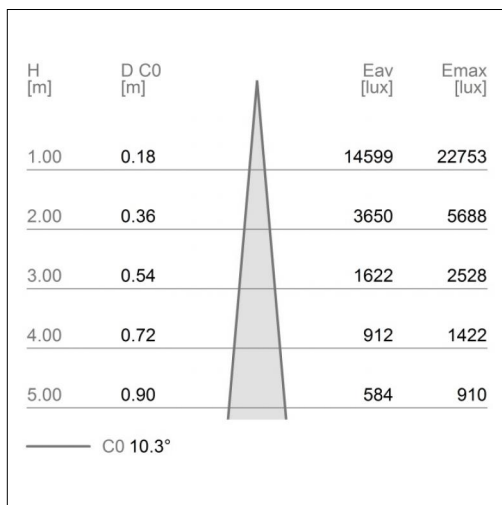

X_MM43B_HC_12.LDT

Specifications text

YORI
Track, channel, recessed and surface mounting fixture. Symmetrical output. Available for LED and metal halide lamps. Die-cast aluminium body. Interchangeable IOS Ø 50mm (LL1) and Ø 80mm (LL2) reflectors in polycarbonate stabilised up to 140° with highly reflective metal coating - exclusive anti-scratch treatment with surface vitrification for LED lamps. Interchangeable IOS Ø 80mm reflectors in 99.99% pure aluminium, with bayonet fitting for metal halide lamps. Anti-static polycarbonate protective screen with a high transmission index (97%); transparent for very narrow light beams, satin for narrow, medium and wide beams and satin/prismatic for the Mira version; anti-yellowing, stabilised against UV rays, resistant to 850° incandescent wire test, self-extinguishing V0; tempered protective glass for IOS reflectors for metal halide lamps Spot adjustable 0° to 90° vertically and 356° horizontally; integrated plastic no-glare screen; recessed optics for improved visual comfort; mounts to false ceilings with the innovative ClikFix one-way spring system (for recessed, semi-recessed and surface mounted versions); drilled bezel for fine mortaring with 0.7 mm trimless bezel thickness for perfect plastering (recessed version); special perforated steel panel maximises heat dispersal outwards (recessed version); vertical slide for moving the luminaire outwards (recessed version); grub screw for locking the adjustment (recessed version); mechanical/electrical connector with m/f connectors (channel version); up to 10 units can be connected in line with a single power supply (channel version); articulated boom for orienting the fixture (for coves, false ceiling and surround versions); available as pre-assembled KIT version with 2, 3 and 4 fixtures for channel, surface and trimless mounting. Anti-yellowing epoxy powder coating, stabilised against UV rays. Product available with the following finishes: matt embossed white 12, matt embossed black 31. Passive heat dissipation via optimised fixture casing construction, which uses the heat conductivity of the metal and convective currents. Available with LED ON/OFF driver, DIMM 1-10V, PHASE CUTTING and DALI 220/240V VAC 50/60 Hz. Electronic driver for LED lamps, electronic power supply for metal halide lamps. Driver/power supply included in package. Isolation class II and III. IP20. The product can be equipped with: cross grille, no-glare honeycomb grille and UV, IR, dichroic and selective filters for food applications. Emergency unit (3 hour) available as accessory equipment. Fixture built in compliance with Standard EN 60598-1 and amendments and EC Directives 2006/95/CE (low voltage), 2004/108/CE (EMC), 2009/125/CE (Ecodesign), 2002/96/CE (RAEE), 2011/65/CE (RoHS).

Luminaire constructed in conformity with Directives 2014/35/EU (LV), 2014/30/EU (EMC), 2009/125/EC (Ecodesign) with Regulations (EC) No 245/2009, (EU) No 347/2010 and (EU) 2015/1428 (for luminaires with fluorescent and metal halide lamps only), 2009/125/EC (Ecodesign) with Regulations (EU) No 1194/2012 and 2015/1428 (for LED luminaires only), 2011/65/EU (RoHS 2) and 2012/19/EU (WEEE).

Optics

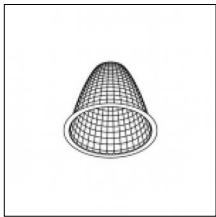

Code 0.35155.0000 - Ø95mm performance optic 10°-12° - LED

Finishing:
Description:



Very narrow 10°

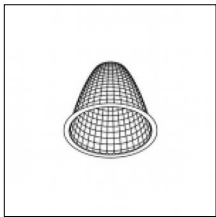

Code 0.35156.0000 - Ø95mm performance optic 20° - LED

Finishing:
Description:



Medium 20°

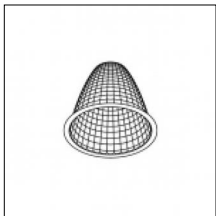

Code 0.35157.0000 - Ø95mm performance optic 31° - LED

Finishing:
Description:



Medium 31°

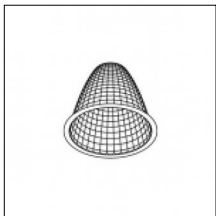

Code 0.35158.0000 - Ø95mm performance optic 40° - LED

Finishing:
Description:



Medium-wide 40°

Driver

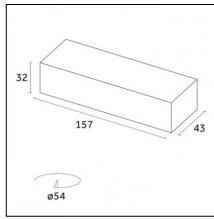

Code 0.30341.0000 - Driver

Type: On-Off

Watt: 25W - AC Input: 220-240Vac - mA:350mA

Description:

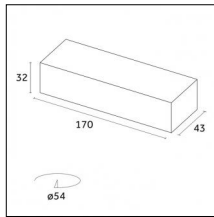

Code D.30341.0000 - Driver

Type: DALI

Watt: 36W - AC Input: 198-264Vac , 170-280Vdc - mA:350mA

Description:

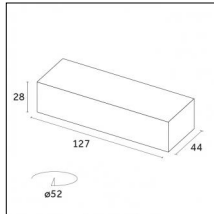

Code T.30412.0000 - Driver Mood

Type: PHASE CUT

Watt: W - AC Input: 220-240Vac - mA:350mA

Description: Connection options: 1

For more information download the dedicated driver board



Code V.30341.0000 - Driver

Type: DIMM 1-10V

Watt: 33W - AC Input: 120-277Vac - mA:350mA

Description:

Accessories

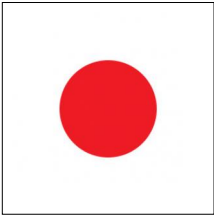

Code 0.26407.004A - Red glass filter 1 mm

Type: Optical
Finishing: Red

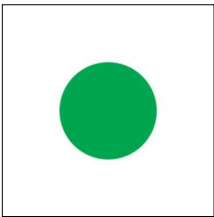

Code 0.26407.005A - Green glass filter 1 mm

Type: Optical
Finishing: Green

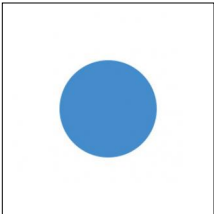

Code 0.26407.006A - Blue glass filter 1 mm

Type: Optical
Finishing: Blue

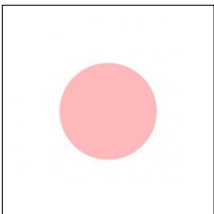

Code 0.26407.007A - Pink glass filter 1 mm

Type: Optical
Finishing: Pink

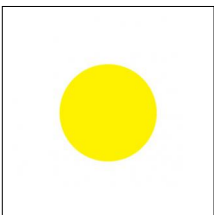

Code 0.26407.008A - Yellow glass filter 1 mm

Type: Optical
Finishing: Yellow



Code 0.26415.0000 - Colored Gel Slides (2 pieces)

Type: Optical
Finishing: Without finish / Stainles Steel / Natural aluminium (Standard)

Accessories

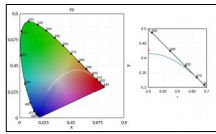
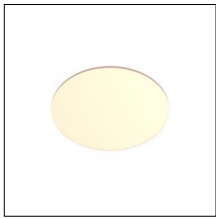

Code 0.26423.0000 - Selective filter 2700K - 2500K

Type: Optical

Finishing: Without finish / Stainles Steel / Natural aluminium (Standard)

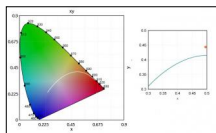
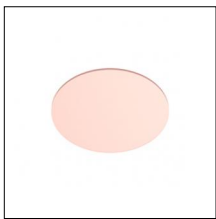

Code 0.26431.0000 - Selective filter 2700K - 2200K

Type: Optical

Finishing: Without finish / Stainles Steel / Natural aluminium (Standard)

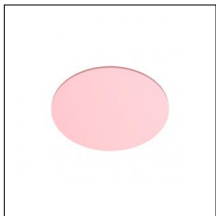

Code 0.26439.0000 - Selective filter 2700K - 2000K

Type: Optical

Finishing: Without finish / Stainles Steel / Natural aluminium (Standard)

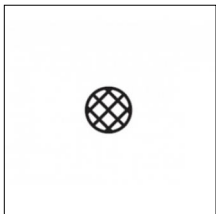

Code 0.26447.0000 - Honeycomb dense texture

Type: Optical

Finishing: Without finish / Stainles Steel / Natural aluminium (Standard)

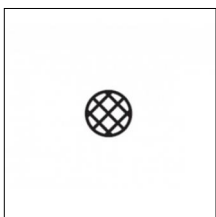

Code 0.26455.0000 - Honeycomb wide texture

Type: Optical

Finishing: Without finish / Stainles Steel / Natural aluminium (Standard)

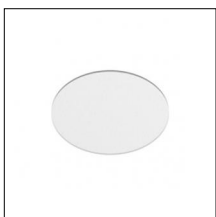

Code 0.26467.0000 - Opal lens

Type: Optical

Finishing: Without finish / Stainles Steel / Natural aluminium (Standard)

Accessories

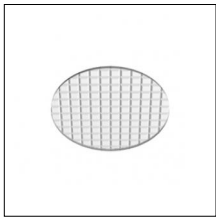

Code 0.26475.0000 - Diffusive lens

Type: Optical
Finishing: Without finish / Stainles Steel / Natural aluminium (Standard)

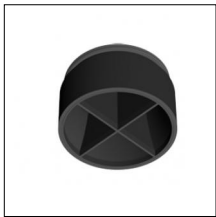

Code 0.26483.0000 - Cross blade louvre

Type: Optical
Finishing: Without finish / Stainles Steel / Natural aluminium (Standard)

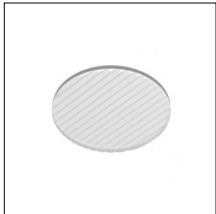

Code 0.26495.0000 - Ribbed glass

Type: Optical
Finishing: Without finish / Stainles Steel / Natural aluminium (Standard)



Code 0.26499.0012 - Cone 45 ° wall washer

Type: Optical
Finishing: Embossed matt white (Standard)



Code 0.26499.0031 - Cone 45 ° wall washer

Type: Optical
Finishing: Embossed matt black (Standard)

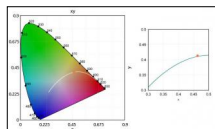
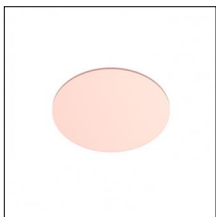

Code 0.26564.0000 - Selective filter 3000K-2700K

Type: Optical
Finishing: Without finish / Stainles Steel / Natural aluminium (Standard)

Accessories

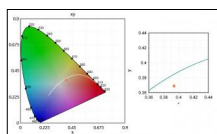
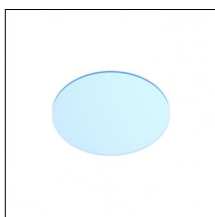

Code 0.26572.0000 - Selective filter 3000K-3600K

Type: Optical

Finishing: Without finish / Stainles Steel / Natural aluminium (Standard)

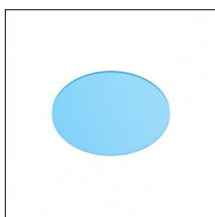

Code 0.26580.0000 - Selective filter 3000K-4000K

Type: Optical

Finishing: Without finish / Stainles Steel / Natural aluminium (Standard)

Indoor | Recessed luminaires | Yori Semi-recessed

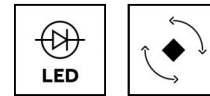
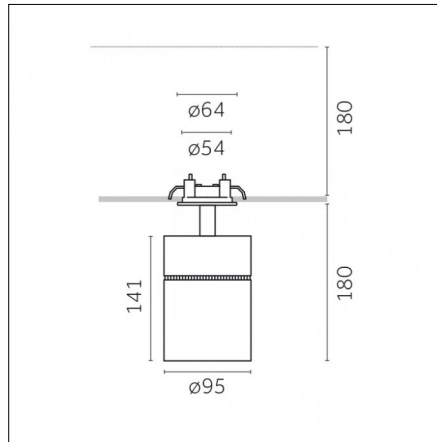

**CUT
OUT**

55mm



Medium 20°

12

IP20



Risk 1

850°



EAC



CE

CB

Code X.MM43E.WW12

Light source features

Number of light sources: 1

Source type: LED WW

Watt: 12W

Lm: 1859lm

Lm/W: 155lm/W

Kelvin/CRI: 3000K / >80

SDCM/L90 B10: < 2 / 50000

Electrical features

Driver included: NO

Driver type: no driver included

Isolation class: Class III

Optical features

Beam angle: 20°

Optical type, adjustability: Adjustable

Interchangeable optic (IOS): YES

Physical features

Material: Die-cast aluminium

Fixing: Ceiling

Adjustability: 90° horizontal axis 356° vertical axis

Finishing: Embossed matt white (Standard)

Weight: 0.9Kg

Luminaire constructed in conformity with Directives 2014/35/EU (LV), 2014/30/EU (EMC), 2009/125/EC (Ecodesign) with Regulations (EC) No 245/2009, (EU) No 347/2010 and (EU) 2015/1428 (for luminaires with fluorescent and metal halide lamps only), 2009/125/EC (Ecodesign) with Regulations (EU) No 1194/2012 and 2015/1428 (for LED luminaires only), 2011/65/EU (RoHS 2) and 2012/19/EU (WEEE).

Reggiani SPA Illuminazione

Viale Monza, 16 20845 Sovico (MB) Italy
Tel. (+39) 039 2071.1 fax (+39) 039 2071 999

www.reggiani.net
contact@reggiani.net

Photometries

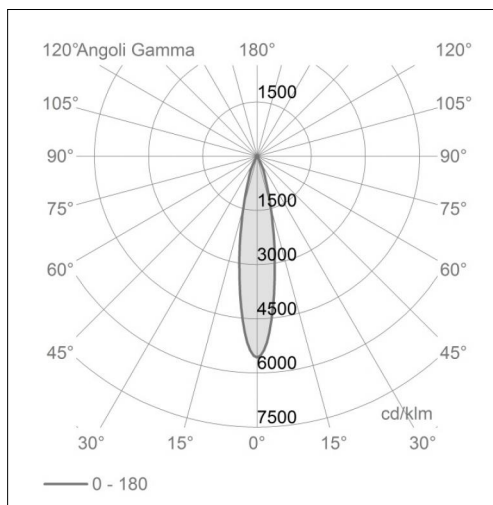
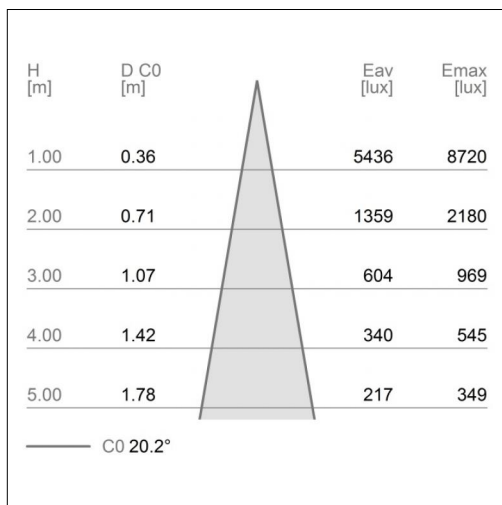

X_MM43E_WW_12.LDT

Specifications text

YORI
Track, channel, recessed and surface mounting fixture. Symmetrical output. Available for LED and metal halide lamps. Die-cast aluminium body. Interchangeable IOS Ø 50mm (LL1) and Ø 80mm (LL2) reflectors in polycarbonate stabilised up to 140° with highly reflective metal coating - exclusive anti-scratch treatment with surface vitrification for LED lamps. Interchangeable IOS Ø 80mm reflectors in 99.99% pure aluminium, with bayonet fitting for metal halide lamps. Anti-static polycarbonate protective screen with a high transmission index (97%); transparent for very narrow light beams, satin for narrow, medium and wide beams and satin/prismatic for the Mira version; anti-yellowing, stabilised against UV rays, resistant to 850° incandescent wire test, self-extinguishing V0; tempered protective glass for IOS reflectors for metal halide lamps Spot adjustable 0° to 90° vertically and 356° horizontally; integrated plastic no-glare screen; recessed optics for improved visual comfort; mounts to false ceilings with the innovative ClikFix one-way spring system (for recessed, semi-recessed and surface mounted versions); drilled bezel for fine mortaring with 0.7 mm trimless bezel thickness for perfect plastering (recessed version); special perforated steel panel maximises heat dispersal outwards (recessed version); vertical slide for moving the luminaire outwards (recessed version); grub screw for locking the adjustment (recessed version); mechanical/electrical connector with m/f connectors (channel version); up to 10 units can be connected in line with a single power supply (channel version); articulated boom for orienting the fixture (for coves, false ceiling and surround versions); available as pre-assembled KIT version with 2, 3 and 4 fixtures for channel, surface and trimless mounting. Anti-yellowing epoxy powder coating, stabilised against UV rays. Product available with the following finishes: matt embossed white 12, matt embossed black 31. Passive heat dissipation via optimised fixture casing construction, which uses the heat conductivity of the metal and convective currents. Available with LED ON/OFF driver, DIMM 1-10V, PHASE CUTTING and DALI 220/240V VAC 50/60 Hz. Electronic driver for LED lamps, electronic power supply for metal halide lamps. Driver/power supply included in package. Isolation class II and III. IP20. The product can be equipped with: cross grille, no-glare honeycomb grille and UV, IR, dichroic and selective filters for food applications. Emergency unit (3 hour) available as accessory equipment. Fixture built in compliance with Standard EN 60598-1 and amendments and EC Directives 2006/95/CE (low voltage), 2004/108/CE (EMC), 2009/125/CE (Ecodesign), 2002/96/CE (RAEE), 2011/65/CE (RoHS).

Luminaire constructed in conformity with Directives 2014/35/EU (LV), 2014/30/EU (EMC), 2009/125/EC (Ecodesign) with Regulations (EC) No 245/2009, (EU) No 347/2010 and (EU) 2015/1428 (for luminaires with fluorescent and metal halide lamps only), 2009/125/EC (Ecodesign) with Regulations (EU) No 1194/2012 and 2015/1428 (for LED luminaires only), 2011/65/EU (RoHS 2) and 2012/19/EU (WEEE).

Optics

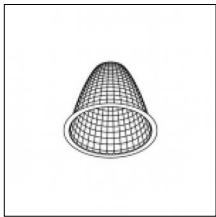

Code 0.35155.0000 - Ø95mm performance optic 10°-12° - LED

Finishing:
Description:



Very narrow 10°

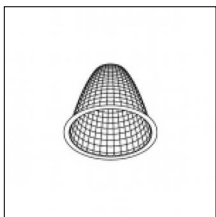

Code 0.35156.0000 - Ø95mm performance optic 20° - LED

Finishing:
Description:



Medium 20°

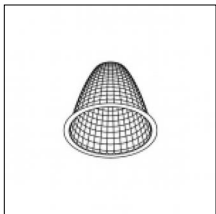

Code 0.35157.0000 - Ø95mm performance optic 31° - LED

Finishing:
Description:



Medium 31°

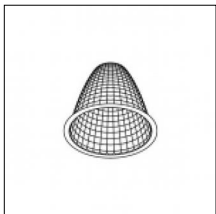

Code 0.35158.0000 - Ø95mm performance optic 40° - LED

Finishing:
Description:



Medium-wide 40°

Driver

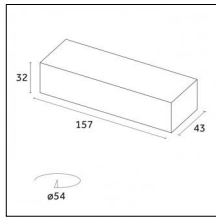

Code 0.30341.0000 - Driver

Type: On-Off
Watt: 25W - AC Input: 220-240Vac - mA:350mA
Description:

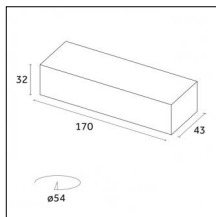

Code D.30341.0000 - Driver

Type: DALI
Watt: 36W - AC Input: 198-264Vac , 170-280Vdc - mA:350mA
Description:

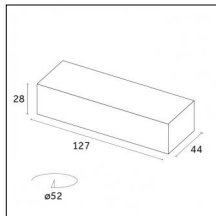

Code T.30412.0000 - Driver Mood

Type: PHASE CUT
Watt: W - AC Input: 220-240Vac - mA:350mA
Description: Connection options: 1
For more information download the dedicated driver board



Code V.30341.0000 - Driver

Type: DIMM 1-10V
Watt: 33W - AC Input: 120-277Vac - mA:350mA
Description:

Accessories

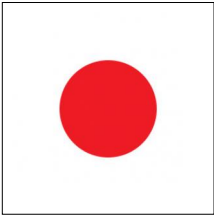

Code 0.26407.004A - Red glass filter 1 mm

Type: Optical
Finishing: Red

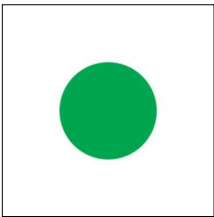

Code 0.26407.005A - Green glass filter 1 mm

Type: Optical
Finishing: Green

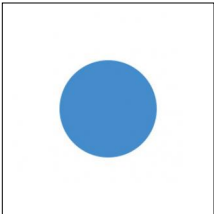

Code 0.26407.006A - Blue glass filter 1 mm

Type: Optical
Finishing: Blue

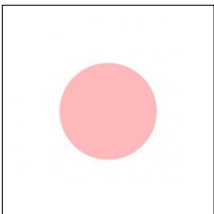

Code 0.26407.007A - Pink glass filter 1 mm

Type: Optical
Finishing: Pink

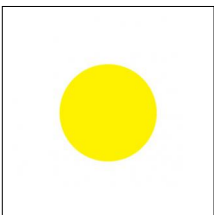

Code 0.26407.008A - Yellow glass filter 1 mm

Type: Optical
Finishing: Yellow



Code 0.26415.0000 - Colored Gel Slides (2 pieces)

Type: Optical
Finishing: Without finish / Stainles Steel / Natural aluminium (Standard)

Accessories

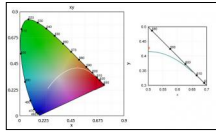
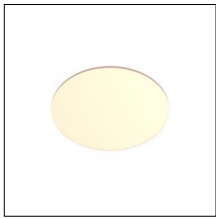

Code 0.26423.0000 - Selective filter 2700K - 2500K

Type: Optical

Finishing: Without finish / Stainles Steel / Natural aluminium (Standard)

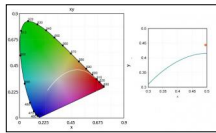
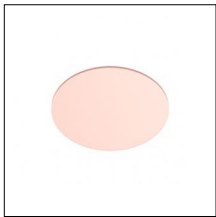

Code 0.26431.0000 - Selective filter 2700K - 2200K

Type: Optical

Finishing: Without finish / Stainles Steel / Natural aluminium (Standard)

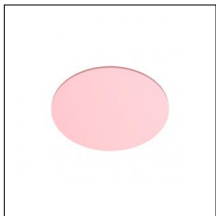

Code 0.26439.0000 - Selective filter 2700K - 2000K

Type: Optical

Finishing: Without finish / Stainles Steel / Natural aluminium (Standard)

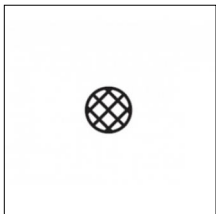

Code 0.26447.0000 - Honeycomb dense texture

Type: Optical

Finishing: Without finish / Stainles Steel / Natural aluminium (Standard)

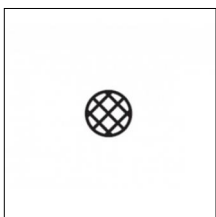

Code 0.26455.0000 - Honeycomb wide texture

Type: Optical

Finishing: Without finish / Stainles Steel / Natural aluminium (Standard)

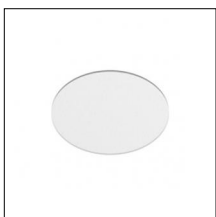

Code 0.26467.0000 - Opal lens

Type: Optical

Finishing: Without finish / Stainles Steel / Natural aluminium (Standard)

Accessories

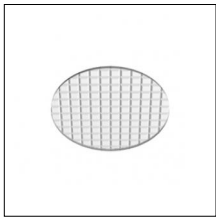

Code 0.26475.0000 - Diffusive lens

Type: Optical
Finishing: Without finish / Stainles Steel / Natural aluminium (Standard)

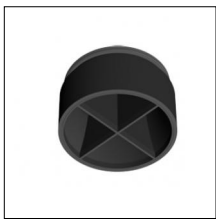

Code 0.26483.0000 - Cross blade louver

Type: Optical
Finishing: Without finish / Stainles Steel / Natural aluminium (Standard)

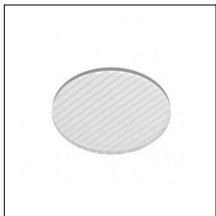

Code 0.26495.0000 - Ribbed glass

Type: Optical
Finishing: Without finish / Stainles Steel / Natural aluminium (Standard)



Code 0.26499.0012 - Cone 45 ° wall washer

Type: Optical
Finishing: Embossed matt white (Standard)



Code 0.26499.0031 - Cone 45 ° wall washer

Type: Optical
Finishing: Embossed matt black (Standard)

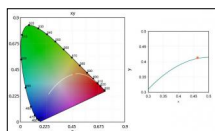
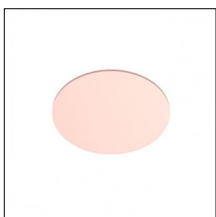

Code 0.26564.0000 - Selective filter 3000K-2700K

Type: Optical
Finishing: Without finish / Stainles Steel / Natural aluminium (Standard)

Accessories

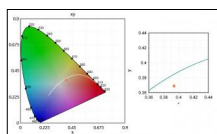
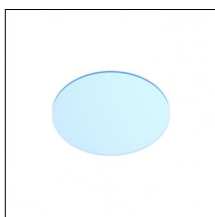

Code 0.26572.0000 - Selective filter 3000K-3600K

Type: Optical

Finishing: Without finish / Stainles Steel / Natural aluminium (Standard)

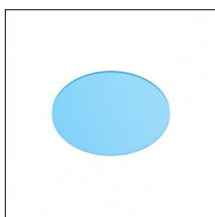

Code 0.26580.0000 - Selective filter 3000K-4000K

Type: Optical

Finishing: Without finish / Stainles Steel / Natural aluminium (Standard)

Indoor | Recessed luminaires | Yori Semi-recessed

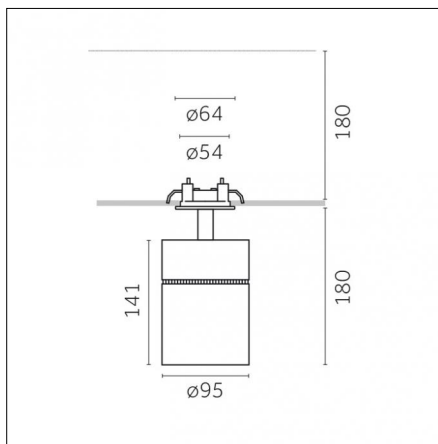

**CUT
OUT**

55mm



Medium 31°

12

IP20



Risk 1

850°



EAC



CE

CB

Code X.MM43H.WW12

Light source features

Number of light sources: 1

Source type: LED WW

Watt: 12W

Lm: 1859lm

Lm/W: 155lm/W

Kelvin/CRI: 3000K / >80

SDCM/L90 B10: < 2 / 50000

Electrical features

Driver included: NO

Driver type: no driver included

Isolation class: Class III

Optical features

Beam angle: 31°

Optical type, adjustability: Adjustable

Interchangeable optic (IOS): YES

Physical features

Material: Die-cast aluminium

Fixing: Ceiling

Adjustability: 90° horizontal axis 356° vertical axis

Finishing: Embossed matt white (Standard)

Weight: 0.9Kg

Luminaire constructed in conformity with Directives 2014/35/EU (LV), 2014/30/EU (EMC), 2009/125/EC (Ecodesign) with Regulations (EC) No 245/2009, (EU) No 347/2010 and (EU) 2015/1428 (for luminaires with fluorescent and metal halide lamps only), 2009/125/EC (Ecodesign) with Regulations (EU) No 1194/2012 and 2015/1428 (for LED luminaires only), 2011/65/EU (RoHS 2) and 2012/19/EU (WEEE).

Reggiani SPA Illuminazione

Viale Monza, 16 20845 Sovico (MB) Italy
Tel. (+39) 039 2071.1 fax (+39) 039 2071 999

www.reggiani.net
contact@reggiani.net

Photometries

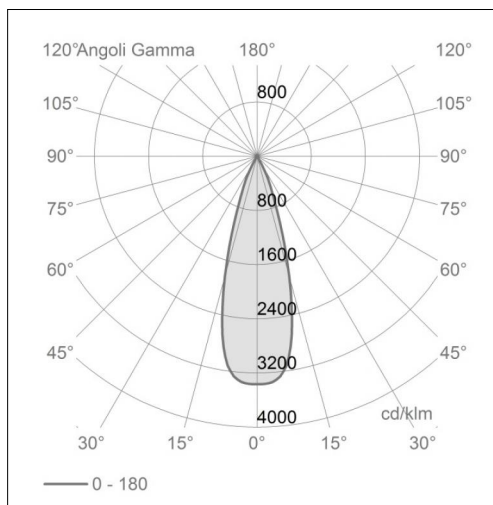
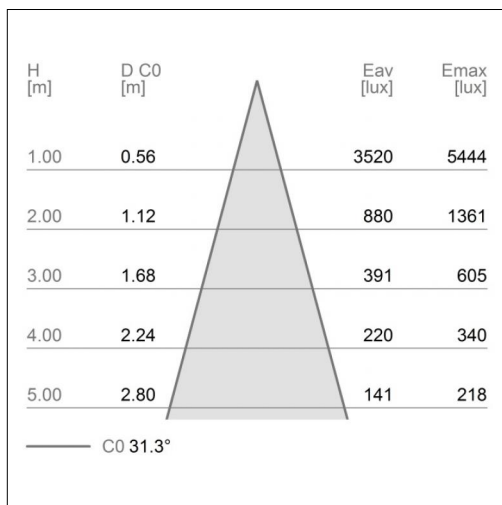

X_MM43H_WW_12.LDT

Specifications text

YORI
Track, channel, recessed and surface mounting fixture. Symmetrical output. Available for LED and metal halide lamps. Die-cast aluminium body. Interchangeable IOS Ø 50mm (LL1) and Ø 80mm (LL2) reflectors in polycarbonate stabilised up to 140° with highly reflective metal coating - exclusive anti-scratch treatment with surface vitrification for LED lamps. Interchangeable IOS Ø 80mm reflectors in 99.99% pure aluminium, with bayonet fitting for metal halide lamps. Anti-static polycarbonate protective screen with a high transmission index (97%); transparent for very narrow light beams, satin for narrow, medium and wide beams and satin/prismatic for the Mira version; anti-yellowing, stabilised against UV rays, resistant to 850° incandescent wire test, self-extinguishing V0; tempered protective glass for IOS reflectors for metal halide lamps Spot adjustable 0° to 90° vertically and 356° horizontally; integrated plastic no-glare screen; recessed optics for improved visual comfort; mounts to false ceilings with the innovative ClikFix one-way spring system (for recessed, semi-recessed and surface mounted versions); drilled bezel for fine mortaring with 0.7 mm trimless bezel thickness for perfect plastering (recessed version); special perforated steel panel maximises heat dispersal outwards (recessed version); vertical slide for moving the luminaire outwards (recessed version); grub screw for locking the adjustment (recessed version); mechanical/electrical connector with m/f connectors (channel version); up to 10 units can be connected in line with a single power supply (channel version); articulated boom for orienting the fixture (for coves, false ceiling and surround versions); available as pre-assembled KIT version with 2, 3 and 4 fixtures for channel, surface and trimless mounting. Anti-yellowing epoxy powder coating, stabilised against UV rays. Product available with the following finishes: matt embossed white 12, matt embossed black 31. Passive heat dissipation via optimised fixture casing construction, which uses the heat conductivity of the metal and convective currents. Available with LED ON/OFF driver, DIMM 1-10V, PHASE CUTTING and DALI 220/240V VAC 50/60 Hz. Electronic driver for LED lamps, electronic power supply for metal halide lamps. Driver/power supply included in package. Isolation class II and III. IP20. The product can be equipped with: cross grille, no-glare honeycomb grille and UV, IR, dichroic and selective filters for food applications. Emergency unit (3 hour) available as accessory equipment. Fixture built in compliance with Standard EN 60598-1 and amendments and EC Directives 2006/95/CE (low voltage), 2004/108/CE (EMC), 2009/125/CE (Ecodesign), 2002/96/CE (RAEE), 2011/65/CE (RoHS).

Luminaire constructed in conformity with Directives 2014/35/EU (LV), 2014/30/EU (EMC), 2009/125/EC (Ecodesign) with Regulations (EC) No 245/2009, (EU) No 347/2010 and (EU) 2015/1428 (for luminaires with fluorescent and metal halide lamps only), 2009/125/EC (Ecodesign) with Regulations (EU) No 1194/2012 and 2015/1428 (for LED luminaires only), 2011/65/EU (RoHS 2) and 2012/19/EU (WEEE).

Optics

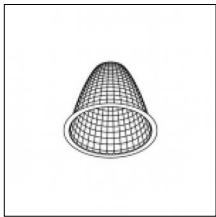

Code 0.35155.0000 - Ø95mm performance optic 10°-12° - LED

Finishing:
Description:



Very narrow 10°

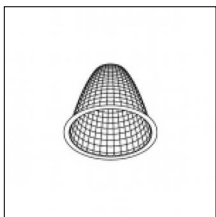

Code 0.35156.0000 - Ø95mm performance optic 20° - LED

Finishing:
Description:



Medium 20°

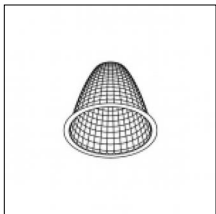

Code 0.35157.0000 - Ø95mm performance optic 31° - LED

Finishing:
Description:



Medium 31°

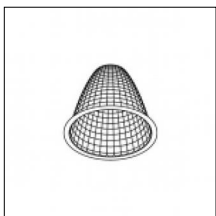

Code 0.35158.0000 - Ø95mm performance optic 40° - LED

Finishing:
Description:



Medium-wide 40°

Driver

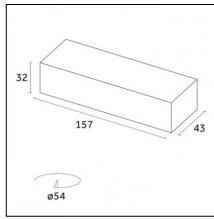

Code 0.30341.0000 - Driver

Type: On-Off
Watt: 25W - AC Input: 220-240Vac - mA:350mA
Description:

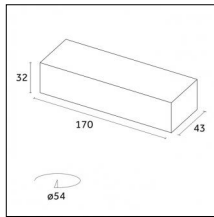

Code D.30341.0000 - Driver

Type: DALI
Watt: 36W - AC Input: 198-264Vac , 170-280Vdc - mA:350mA
Description:

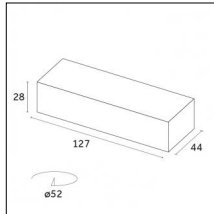

Code T.30412.0000 - Driver Mood

Type: PHASE CUT
Watt: W - AC Input: 220-240Vac - mA:350mA
Description: Connection options: 1
For more information download the dedicated driver board



Code V.30341.0000 - Driver

Type: DIMM 1-10V
Watt: 33W - AC Input: 120-277Vac - mA:350mA
Description:

Accessories

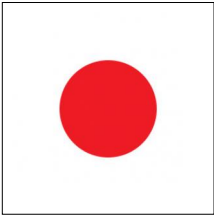

Code 0.26407.004A - Red glass filter 1 mm

Type: Optical
Finishing: Red

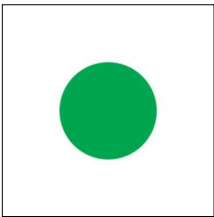

Code 0.26407.005A - Green glass filter 1 mm

Type: Optical
Finishing: Green

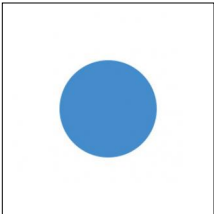

Code 0.26407.006A - Blue glass filter 1 mm

Type: Optical
Finishing: Blue

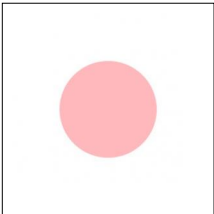

Code 0.26407.007A - Pink glass filter 1 mm

Type: Optical
Finishing: Pink

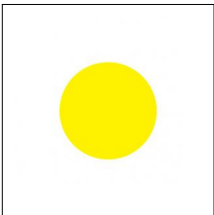

Code 0.26407.008A - Yellow glass filter 1 mm

Type: Optical
Finishing: Yellow



Code 0.26415.0000 - Colored Gel Slides (2 pieces)

Type: Optical
Finishing: Without finish / Stainles Steel / Natural aluminium (Standard)

Accessories

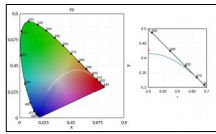
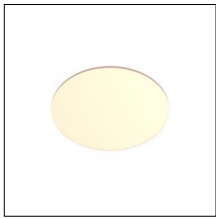

Code 0.26423.0000 - Selective filter 2700K - 2500K

Type: Optical

Finishing: Without finish / Stainles Steel / Natural aluminium (Standard)

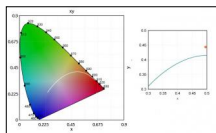
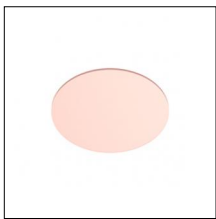

Code 0.26431.0000 - Selective filter 2700K - 2200K

Type: Optical

Finishing: Without finish / Stainles Steel / Natural aluminium (Standard)

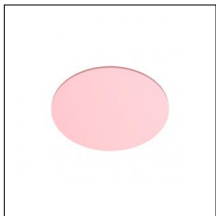

Code 0.26439.0000 - Selective filter 2700K - 2000K

Type: Optical

Finishing: Without finish / Stainles Steel / Natural aluminium (Standard)

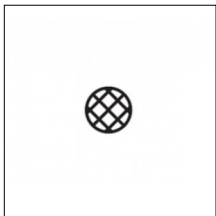

Code 0.26447.0000 - Honeycomb dense texture

Type: Optical

Finishing: Without finish / Stainles Steel / Natural aluminium (Standard)

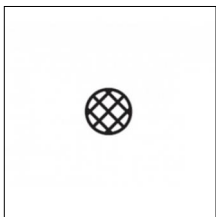

Code 0.26455.0000 - Honeycomb wide texture

Type: Optical

Finishing: Without finish / Stainles Steel / Natural aluminium (Standard)

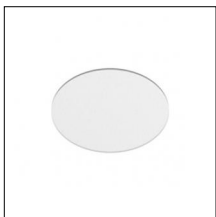

Code 0.26467.0000 - Opal lens

Type: Optical

Finishing: Without finish / Stainles Steel / Natural aluminium (Standard)

Accessories

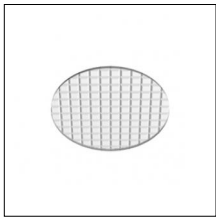

Code 0.26475.0000 - Diffusive lens

Type: Optical
Finishing: Without finish / Stainles Steel / Natural aluminium (Standard)

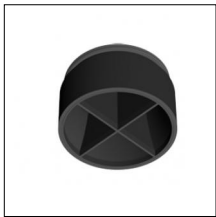

Code 0.26483.0000 - Cross blade louvre

Type: Optical
Finishing: Without finish / Stainles Steel / Natural aluminium (Standard)

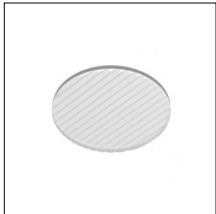

Code 0.26495.0000 - Ribbed glass

Type: Optical
Finishing: Without finish / Stainles Steel / Natural aluminium (Standard)



Code 0.26499.0012 - Cone 45 ° wall washer

Type: Optical
Finishing: Embossed matt white (Standard)



Code 0.26499.0031 - Cone 45 ° wall washer

Type: Optical
Finishing: Embossed matt black (Standard)

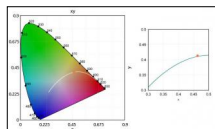
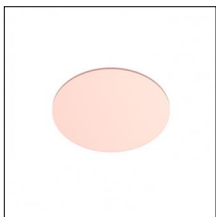

Code 0.26564.0000 - Selective filter 3000K-2700K

Type: Optical
Finishing: Without finish / Stainles Steel / Natural aluminium (Standard)

Accessories

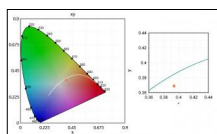
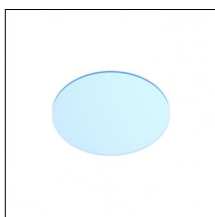

Code 0.26572.0000 - Selective filter 3000K-3600K

Type: Optical

Finishing: Without finish / Stainles Steel / Natural aluminium (Standard)

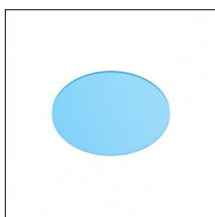

Code 0.26580.0000 - Selective filter 3000K-4000K

Type: Optical

Finishing: Without finish / Stainles Steel / Natural aluminium (Standard)