

design: R&D

WALK EVO WALK EVO-S

LAM32
IDEAS BECOMING LIGHT

Apparecchio pensato per l'installazione ad incasso su pareti e soffitti, finalizzato all'impiego di sorgenti LED di potenza con luce radente. Corpo realizzato in alluminio anticorrosivo sottoposto a trattamento di anodizzazione per garantire l'inalterabilità nel tempo e la massima resistenza agli attacchi degli agenti atmosferici. Tutte le componenti metalliche degli apparecchi di questa serie possono essere realizzate a richiesta interamente in acciaio inox 316L. L'installazione è consentita a pressione su apposita controcassa in materiale plastico. Il grado di protezione dell'apparecchio IP66 è garantito dalla presenza di guarnizioni al silicone dedicate e apposito sistema pressacavo. La presenza di driver LED integrato permette la loro alimentazione a 24VDC. Dotato di 50cm di cavo per il collegamento alla linea di alimentazione con sistemi di giunzione stagna non inclusi. Alimentatore remoto non incluso.

Luminaire designed for recessed installation on walls and ceilings. Suitable for power LED sources for light grazing. The body is made of Anticorrosive aluminium, submitted to anodizing treatment to ensure durability over time and maximum resistance against atmospheric agents. All the metal components of the luminaires of this series can be fully made of AISI 316L stainless steel, on request. The installation can be done under a pressure on a special plastic casing, to be ordered separately. The protection degree IP66 is guaranteed by a special waterproof cable gland system and silicone gasket. The integrated LED driver allows its power at 24VDC. It is equipped with a 50cm long neoprene cable for connection to the power supply line, through appropriate waterproof connection systems not included. Remote power supply not included.

WALK EVO

WALK EVO-S



DISEGNO TECNICO/TECHNICAL DRAWING

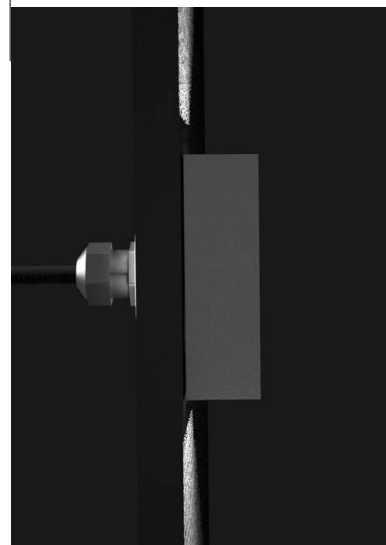
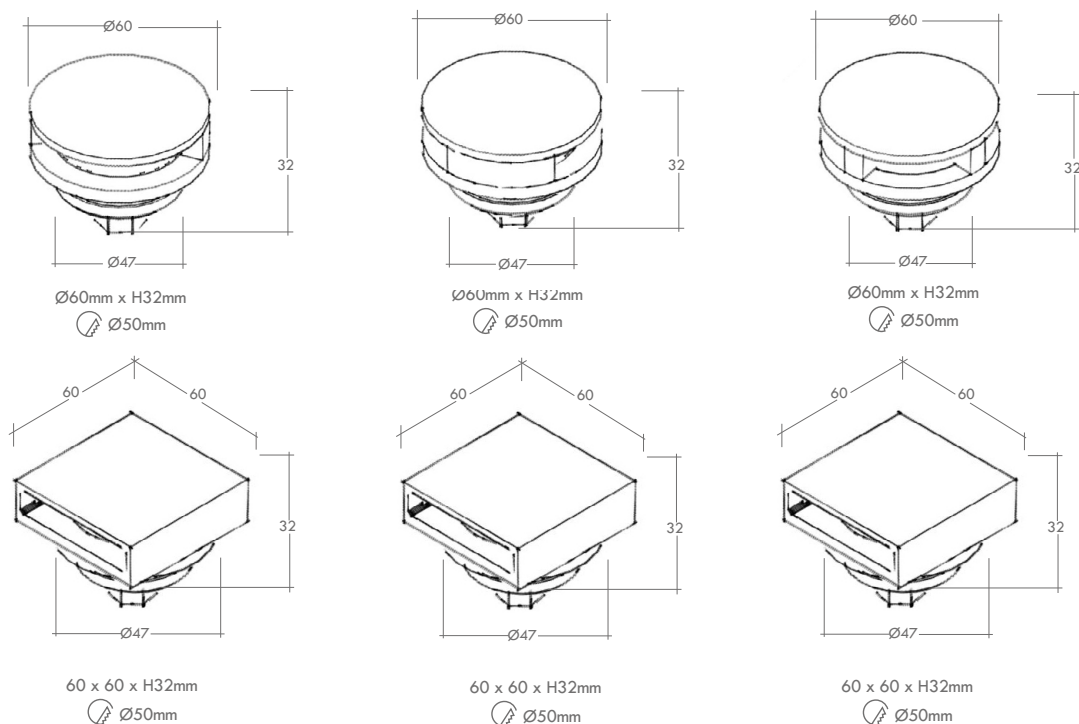

nome/ name	codice/ code	sorgente/ lamp	lumen/lumens		
			2700K	3000K	4000K
Walk Evo 1	08.104045	LED 4W	440	475	510
Walk Evo 2	08.104044	LED 4W	440	475	510
Walk Evo 3	08.104043	LED 4W	440	475	510
Walk Evo 1-S	08.104046	LED 4W	440	475	510
Walk Evo 2-S	08.104047	LED 4W	440	475	510
Walk Evo 3-S	08.104048	LED 4W	440	475	510

ESEMPIO COMPOSIZIONE CODICE / EXAMPLE OF CODE COMPOSITION

Alimentatore elettronico 24VDC da ordinare come accessorio. Elettroniche di controllo: iSmart CV, iColor CV o iDimm CV, da ordinare come accessorio.

24VDC Electronic driver to be ordered as an accessory. Control Electronics: iSmart CV, iColor CV or iDimm CV, to be ordered as an accessory.

ACCESSORI/ACCESSORIES

	codice/ code	
	20.104145	Cassaforma/Case IP20 Dimensioni/Sizes Ø90mm x H85mm Foro/Hole Ø48mm
	20.104159	Molla per installazione su parete o soffitto in cartongesso./Spring for installing on wall or ceiling in plasterboard.

08.104045.03.AS.BF

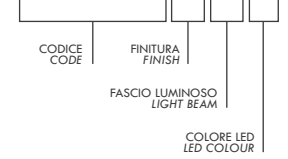

Fascio luminoso/Light beam	
.AS	asimmetrico/asymmetric
Colore LED/LED Colour	
.BC	2700K
.BP	3000K
.BF	4000K

FINITURA/FINISH

colore/colour	codice/code	colore/colour	codice/code	colore/colour	codice/code
	.01 / verniciato bianco painted white		.02 / verniciato nero painted black		.03 / verniciato alluminio painted aluminium
	.04 / verniciato cor-ten painted cor-ten		.11 / verniciato antracite painted anthracite		

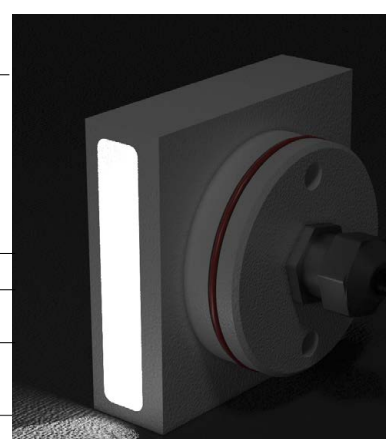

LETTURA DEL CATALOGO READING THE CATALOGUE

NOME FAMIGLIA
SERIES NAME

FLAT EVO

DESIGN: R&D

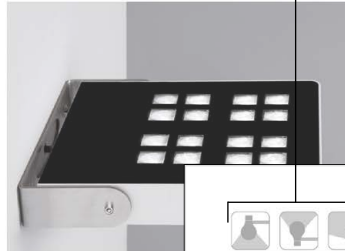

Apparecchio realizzato in lega di alluminio Anticorrodal, per l'impiego continuo in ambito esterno, pensato per l'installazione a pavimento, parete e soffitto per mezzo di staffa orientabile in acciaio inox dotata di scala graduata e blocco meccanico del puntamento. Finalizzato all'impiego di sorgenti LED di alta potenza ha corpo sottoposto a trattamento di anodizzazione fino a 18 micron e verniciato a polveri di poliestere per garantire l'inalterabilità nel tempo e la massima resistenza agli attacchi di agenti atmosferici. Completa la struttura uno specifico schermo in vetro extrachiaro serigrafato e temprato, solidale al corpo mediante apposito collante-sigillante di derivazione navale. Il grado di protezione dell'apparecchio IP66 è garantito dalla presenza di apposito sistema pressocavo stagno inserito nell'apparecchio. Ottiche di precisione in PMMA, consentono la propagazione del fascio luminoso a grandi distanze. La presenza di driver integrato ad ogni apparecchio permette la loro alimentazione a 230VAC. Dotato di 50cm di cavo in neoprene per il collegamento alla linea di alimentazione mediante appositi sistemi di giunzione da ordinare separatamente.

Luminaire made of anticorrodal alloy in outdoors area. It is designed for through stainless steel adjustable bracket, its body is submitted to anodization and polyester powder coated to get maximum resistance against atmospheric agents. Completing the structure through a special glue-sealant of marine derivation. The protection degree IP66 is ensured by the presence of a special gasket system inserted into the luminaire. Precision optics allow the propagation of light beam at long distances. The presence of an integrated driver allows the supply at 230VAC. It is equipped with a 50cm long neoprene cable for connection to the supply line, connection systems to be ordered separately.

TIPI DI EMISSIONE LUMINOSA
TYPE OF LIGHT EMISSION

CONFIGURAZIONI DISPONIBILI
AVAILABLE CONFIGURATIONS

MARCHI E REQUISITI
MARKING AND REQUIREMENTS



45 x 77 x H40mm

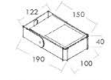

100 x 190 x H40mm

FLAT EVO 1

codice/code	ottica/optic	sorgente/lamp	lumen/lumens
			3000K 4000K
03.104050	.SP .MD .FL .RD	LED 1x2,2W	214 288

FLAT EVO 2

codice/code	ottica/optic	sorgente/lamp	lumen/lumens
			3000K 4000K
03.104051	.SP .MD .FL .RD	LED 4x2,2W	1020 1105

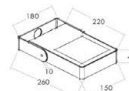

150 x 260 x H40mm

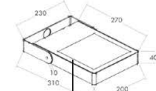

200 x 310 x H40mm

FLAT EVO 3

codice/code	ottica/optic	sorgente/lamp	lumen/lumens
			3000K 4000K
03.104052	.SP .MD .FL .RD	LED 8x2,2W	2040 2205
	.AS	LED 17,5W	2809 2896

FLAT EVO 4

codice/code	ottica/optic	sorgente/lamp	lumen/lumens
			3000K 4000K
03.104053	.SP .MD .FL .RD	LED 16x2,2W	3885 4205
	.AS	LED 25,7W	3810 3928

ESEMPIO COMPOSIZIONE CODICE / EXAMPLE OF CODE COMPOSITION

Alimentatore elettronico 220/240V 50-60Hz integrato nel corpo dell'apparecchio.

Electronic driver 220/240V 50-60Hz integrated in the luminaire's body.

03.104050.01.AS.BF



Fascio luminoso/Light beam

.SP	fascio/beam 10°-15°
.MD	fascio/beam 20-35°
.FL	fascio/beam 40-55°
.RD	road
.VE	vertical elliptical 8°x48°
.HE	horizontal elliptical 48°x8°

Colore LED/LED Colour

.SP	3000K
.BF	4000K

FINITURA / FINISH

colore/colour	codice/code	colore/colour	codice/code	colore/colour	codice/code
[White]	.01 / verniciato bianco painted white	[Black]	.02 / verniciato nero painted black	[Anodized]	.03 / alluminio anodizzato anodized aluminium
[Car-Ten]	.04 / verniciato cor-ten painted cor-ten	[Anti-Trace]	.11 / verniciato anticraque painted anti-crack		

DESCRIZIONE TECNICA DELL'APPARECCHIO LUMINAIRE TECHNICAL DESCRIPTION

.08/cemento	.08/concrete
.06/alluminio lucido o inox lucido	.06/polished aluminium or polished stainless
.05/alluminio satinato o inox satinato	.05/satin aluminium or satin stainless
.04/verniciato cor-ten	.04/painted cor-ten
.03 verniciato grigio (RAL 9006) o alluminio anodizzato	.03/painted grey (RAL 9006) or anodized aluminium
.02/verniciato nero (RAL 9005) o anodizzato nero	.02/painted black (RAL 9005) or black anodized
.01/verniciato bianco (RAL 9016)	.01/painted white (RAL 9016)
.00/naturale	.00/natural

FINITURE DISPONIBILI
AVAILABLE FINISHES

TABELLA COMPOSIZIONE CODICE
CODE COMPOSITION TABLE

DESCRIZIONE SORGENTE LAMP DESCRIPTION

CODICE RADICE APPARECCHIO
LUMINAIRE CODE

OTTICHE
OPTICS

DISEGNO TECNICO TECHNICAL DRAWING

SIMBOLOGIA SYMBOLS

Configurazioni disponibili/Available configurations

	Apparecchio disponibile in versione RGB (solo per versioni con min. 3 lampade o versioni LED).	Luminaire available in RGB version (only for versions with a min. of 3 lamps or LED versions).
	Apparecchio disponibile in versione CTC (controllo temperatura di colore, solo per versioni con min. 3 lampade o versioni LED).	Luminaire available in CTC version (colour temperature control, only for versions with a min. of 3 lamps or LED versions).
	Apparecchio con possibilità di dimmerazione.	Luminaire has possibility to be dimmed.
	Apparecchio con possibilità di dimmerazione 0/10.	Luminaire has possibility to be dimmed 0/10.
	Apparecchio con possibilità di dimmerazione DALI.	Luminaire has possibility to be dimmed DALI.
	Apparecchio con possibilità di dimmerazione PWM.	Luminaire has possibility to be dimmed PWM.
	Apparecchio disponibile con apparato di diffusione sonora ad induzione.	Luminaire available with induction sound diffusion system.
	Apparecchio disponibile con Router Wi-Fi interno per la diffusione nello spazio circostante di segnali wire-less di ogni genere.	Luminaire available with internal Wi-Fi Router for the diffusion of any kind of wireless signal in the surrounding space.
	Kit emergenza	Emergency Kit
	Apparecchio personalizzabile (con fattibilità da verificare). Modifiche su richiesta: -finitura RAL -dimensione -tecnologia di comunicazione (DALI,WIFI o AUDIO integrato)	Luminaire customizable (with feasibility to be checked). Changes on request: -RAL finish -size -communication technology (integrated DALI, WIFI or AUDIO)
	Apparecchio disponibile a richiesta in versione RGB (solo per versioni con sorgente LED o con minimo 3 lampade).	Luminaire available, on request, in RGB version (only for LED versions or with a minimum of 3 lamps).
	Apparecchio disponibile a richiesta in versione CTC (controllo temperatura di colore, solo per versioni con min. 3 lampade o versioni LED).	Luminaire available, on request, in CTC version (colour temperature control, only for versions with a min. of 3 lamps or LED versions).
	Apparecchio disponibile su richiesta in versione dimmerabile.	Luminaire available, on request, in dimmable version.
	Apparecchio disponibile, su richiesta, con schermo microprismatizzato per elevato comfort visivo.	Luminaire available, on request, with microprismatic screen for high visual comfort.
	Protezione Acqua Stop	Water Stop protection

Protezioni IP/IP Protection degree code

1° CIFRA - Protezione da corpi solidi/

IP1...	Protezione da corpi solidi $\geq 50\text{mm}$
IP2...	Protezione da corpi solidi $\geq 12\text{mm}$
IP3...	Protezione da corpi solidi $\geq 2,5\text{mm}$
IP4...	Protezione da corpi solidi $\geq 1\text{mm}$
IP5...	Protezione da polvere
IP6...	Protezione totale da polvere

1st DIGIT – Protection against solid bodies

IP1...	Protection against solid bodies $\geq 50\text{mm}$
IP2...	Protection against solid bodies $\geq 12\text{mm}$
IP3...	Protection against solid bodies $\geq 2,5\text{mm}$
IP4...	Protection against solid bodies $\geq 1\text{mm}$
IP5...	Protection against dust
IP6...	Total protection against dust

2° CIFRA - Protezione da acqua

IP..1	Protezione da caduta di gocce verticali
IP..2	Protezione da caduta di gocce con inclinazione di 15°
IP..3	Protezione da spruzzi d'acqua con inclinazione di 60° dall'alto
IP..4	Protezione dagli spruzzi d'acqua da ogni direzione
IP..5	Protezione dai getti d'acqua
IP..6	Protezione da inondazioni
IP..7	Protezione contro l'immersione temporanea fino a $30'$ sotto 1m d'acqua
IP..8	Protezione contro l'immersione continua sotto 1m d'acqua













2nd DIGIT – Protection against water

IP..1	Protection against vertically falling drops
IP..2	Protection against vertically falling drops with a tilt angle up to 15°
IP..3	Protection against sprays of water up to 60° from devertical
IP..4	Protection against water spray from all directions
IP..5	Protection against water jets
IP..6	Protection against powerful water jets
IP..7	Protection against temporary immersion up to $30'$ under 1m of water
IP..8	Protection against continuous immersion under 1m of water

Tipologia di alimentazione/Power supply type



Marchi e requisiti/Certificates and requirements

	Apparecchio in classe prima con isolamento elettrico fondamentale. Deve essere collegato al circuito di terra dell'impianto elettrico generale.	Class I Luminaire with basic electrical insulation. It must be connected to the earth circuit of the general electrical system.
	Apparecchio in classe seconda con doppio isolamento elettrico. Non necessita di collegamento al circuito di terra dell'impianto elettrico.	Class II luminaire with double electrical insulation. There is no need for connection to the earth circuit of the electrical system.
	Apparecchio in classe terza predisposto per il collegamento a circuiti a bassissima tensione.	Class III luminaire suitable for connection to extra-low voltage circuits.
	Marchatura CE	CE Marking
	L'apparecchio può essere installato su superfici normalmente infiammabili.	The luminaire can be installed on normally flammable surfaces.
		
	ISO 9001	
	Ellissi di Macadam.	Macadam Ellipse.
	Resistenza al carico statico.	Static load resistance.
	Lunghezza del cavo di alimentazione in dotazione.	Length of supplied power cable.
	Uscita cavo di alimentazione L= Laterale P= Posteriore T= Testa	Cable Output L= Side P= Rear T= Head
	Protezione contro sbalzi di tensione	Protection against sudden changes in voltage.
	Protezione contro l'inversione di polarità	Reverse polarity protection.
	Rotazione dell'apparecchio sull'asse verticale.	Luminaire rotation on vertical axis.
	Inclinazione dell'apparecchio sull'asse orizzontale.	Luminaire inclination on horizontal axis.
	Tipo di emissione luminosa.	Type of light emission.

Resistenza agli urti/Shock resistance

	IK00 Non protetto/ No protection	IK03 0,35 J	IK07 2,00 J
	IK01 0,15 J	IK04 0,50 J	IK08 5,00 J
	IK02 0,20 J	IK05 0,70 J	IK09 10,00 J
		IK06 1,00 J	IK10 20,00 J

Condizioni generali/General Conditions

Le potenze ed i flussi luminosi indicati nel presente catalogo sono riferiti alle sorgenti LED.

Wattage and lumens indicated in this catalogue are referred to the LED sources.

Lam32 srl si riserva il diritto di apportare modifiche ai prodotti della collezione al fine di miglioramento o per esigenza di carattere tecnico e commerciale. Vi invitiamo a consultare il sito www.lam32.com per avere i dati continuamente aggiornati.

Lam32 Ltd reserves the right to make every changes to the products of the this collection, to improve the betterment, or to meet the technical and commercial needs. We invite you to visit the website www.lam32.com, as to have always the data updated.