

Indoor | Recessed luminaires | Traceline Recessed

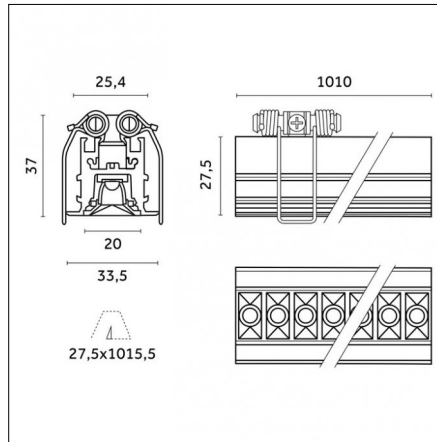
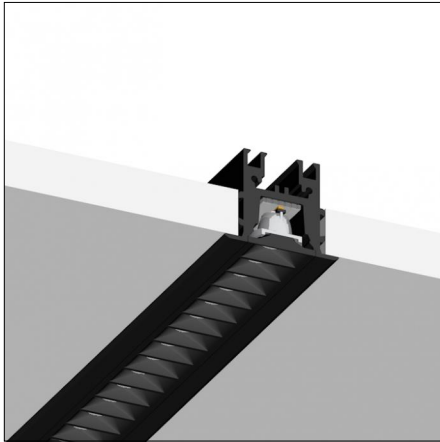

Very wide 40°

01

IP20



850°



Code X.CN35L.HC01

Light source features

Number of light sources: 1

Source type: LED HC

Watt: 21W

Lm: 2912lm

Lm/W: 143lm/W

Kelvin/CRI: 3000K / >95

SDCM/L80 B10: < 3 / 50000

Fixture total output: 1910 lm

Fixture efficacy: 79 lm/W

Electrical features

Driver included: NO

Driver position: remote

Driver type: no driver included 24V DC

Total power consumption (LED + DRIVER): 24W

Isolation class: Class III

Driver note: See wiring diagrams for configurations

Optical features

Beam angle: 40°

Interchangeable optic (IOS): NO

UGR : < 16

Physical features

Material: Extruded aluminum

Diffusing screen: Dark Performance

Mounting: Recessed

Finishing: Chrome

Notes:

End caps not included, to be ordered separately

Luminaire constructed in conformity with Directives 2014/35/EU (LV), 2014/30/EU (EMC), 2009/125/EC (Ecodesign) with Regulations (EC) No 245/2009, (EU) No 347/2010 and (EU) 2015/1428 (for luminaires with fluorescent and metal halide lamps only), 2009/125/EC (Ecodesign) with Regulations (EU) No 1194/2012 and 2015/1428 (for LED luminaires only), 2011/65/EU (RoHS 2) and 2012/19/EU (WEEE).

Reggiani SPA Illuminazione

Viale Monza, 16 20845 Sovico (MB) Italy
Tel. (+39) 039 2071.1 fax (+39) 039 2071 999

www.reggiani.net
contact@reggiani.net

Driver

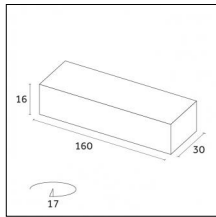

Code 0.30820.0000 - Driver

Type: On-Off
Watt: W - AC Input: 220-240Vac - mA:mA
Description:

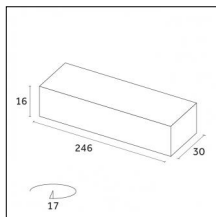

Code 0.30821.0000 - Driver

Type: On-Off
Watt: W - AC Input: 220-240Vac - mA:mA
Description:

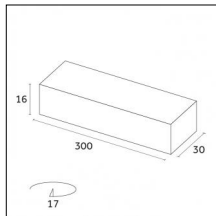

Code 0.30822.0000 - Driver

Type: On-Off
Watt: W - AC Input: 120-240V - mA:mA
Description:

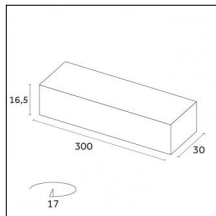

Code 0.30823.0000 - Driver

Type: On-Off
Watt: W - AC Input: 220-240Vac - mA:mA
Description:

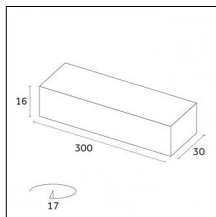

Code 0.30824.0000 - Driver

Type: On-Off
Watt: W - AC Input: 120-240V - mA:mA
Description:

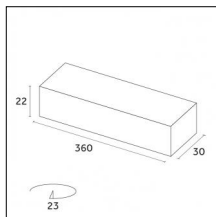

Code 0.30825.0000 - Driver

Type: On-Off
Watt: W - AC Input: 120-240V - mA:mA
Description:

Driver

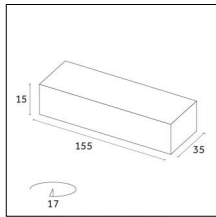

Code H.30826.0000 - Dimmer - 1 channel

Type: Bluetooth
Watt: W - AC Input: 24-48Vcc - mA:mA
Description:

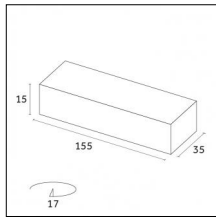

Code H.30827.0000 - Dimmer - 2 channels - for Tunable White

Type: Bluetooth
Watt: W - AC Input: 24-48Vcc - mA:mA
Description:

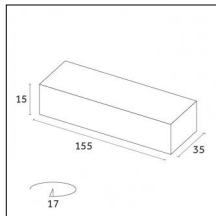

Code Y.30826.0000 - Dimmer -1 channel

Type: Dimmer 1-10V / DALI / PUSH
Watt: W - AC Input: 24-48Vcc - mA:mA
Description:

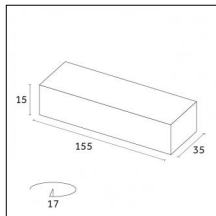

Code Y.30827.0000 - Dimmer - 2 channels - for Tunable White

Type: Dimmer 1-10V / DALI / PUSH
Watt: W - AC Input: 24-48Vcc - mA:mA
Description:

Accessories

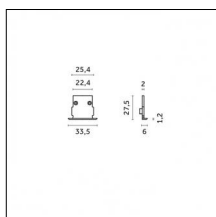
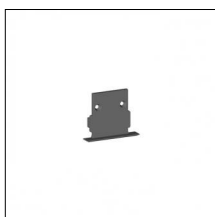

Code 0.26808.0001 - End caps (2x) Traceline Recessed Trim

Type: Mounting
Finishing: Chrome

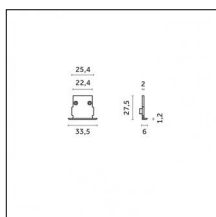
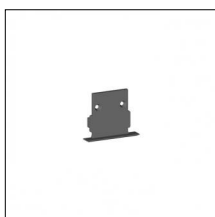

Code 0.26808.0012 - End caps (2x) Traceline Recessed Trim

Type: Mounting
Finishing: Embossed matt white (Standard)

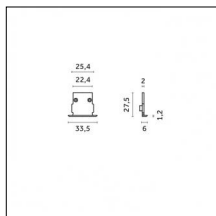
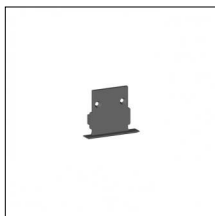

Code 0.26808.0031 - End caps (2x) Traceline Recessed Trim

Type: Mounting
Finishing: Embossed matt black (Standard)

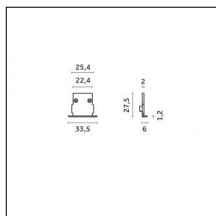
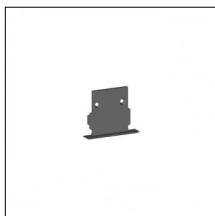

Code 0.26808.00B0 - End caps (2x) Traceline Recessed Trim

Type: Mounting
Finishing: Royal matt black

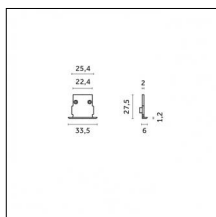
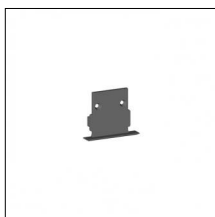

Code 0.26808.00C0 - End caps (2x) Traceline Recessed Trim

Type: Mounting
Finishing: Royal matt white

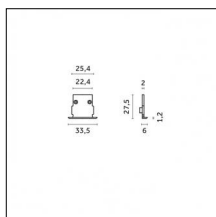
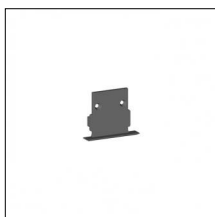

Code 0.26808.00D0 - End caps (2x) Traceline Recessed Trim

Type: Mounting
Finishing: Brushed brass

Luminaire constructed in conformity with Directives 2014/35/EU (LV), 2014/30/EU (EMC), 2009/125/EC (Ecodesign) with Regulations (EC) No 245/2009, (EU) No 347/2010 and (EU) 2015/1428 (for luminaires with fluorescent and metal halide lamps only), 2009/125/EC (Ecodesign) with Regulations (EU) No 1194/2012 and 2015/1428 (for LED luminaires only), 2011/65/EU (RoHS 2) and 2012/19/EU (WEEE).

Accessories

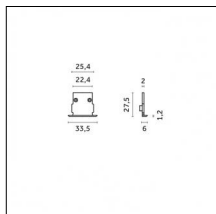
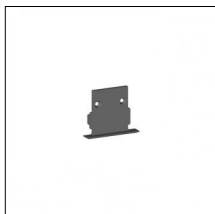

Code 0.26808.00E0 - End caps (2x) Traceline Recessed Trim

Type: Mounting
Finishing: Brushed gold

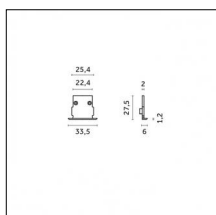
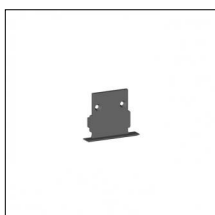

Code 0.26808.00L0 - End caps (2x) Traceline Recessed Trim

Type: Mounting
Finishing: Antiqued brushed bronze

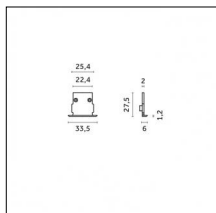
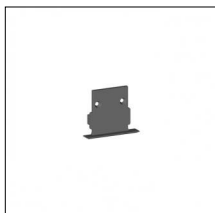

Code 0.26808.00M0 - End caps (2x) Traceline Recessed Trim

Type: Mounting
Finishing: Brushed aluminum

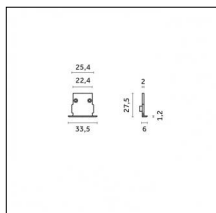
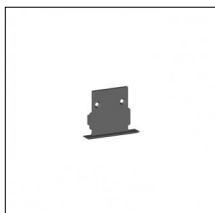

Code 0.26808.00N0 - End caps (2x) Traceline Recessed Trim

Type: Mounting
Finishing: Brushed copper

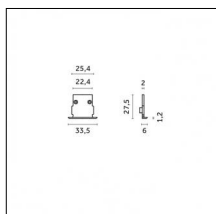
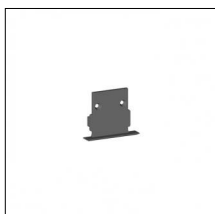

Code 0.26808.00T1 - End caps (2x) Traceline Recessed Trim

Type: Mounting
Finishing: Anodized Bronze

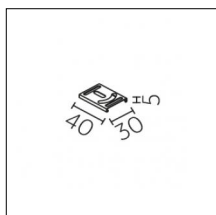

Code 0.26879.0000 - 3-way distributor - (1in - 2out)

Type: Electrical
Finishing: Without finish / Stainles Steel / Natural aluminium (Standard)
Description:

1in - 2out - 16A-250V

Polyamide body

Silver plated brass contacts

Luminaire constructed in conformity with Directives 2014/35/EU (LV), 2014/30/EU (EMC), 2009/125/EC (Ecodesign) with Regulations (EC) No 245/2009, (EU) No 347/2010 and (EU) 2015/1428 (for luminaires with fluorescent and metal halide lamps only), 2009/125/EC (Ecodesign) with Regulations (EU) No 1194/2012 and 2015/1428 (for LED luminaires only), 2011/65/EU (RoHS 2) and 2012/19/EU (WEEE).

Accessories

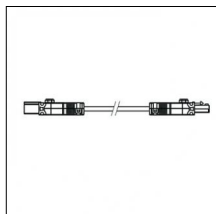

Code 0.26880.0000 - Plug to Socket with extension cable

Type: Electrical

Finishing: Without finish / Stainles Steel / Natural aluminium (Standard)

Description:

Extension cable multicore 1x2,5mm

16A-250V

Cable length 3000mm

Maximum capacity 84W/3m

Indoor | Recessed luminaires | Traceline Recessed

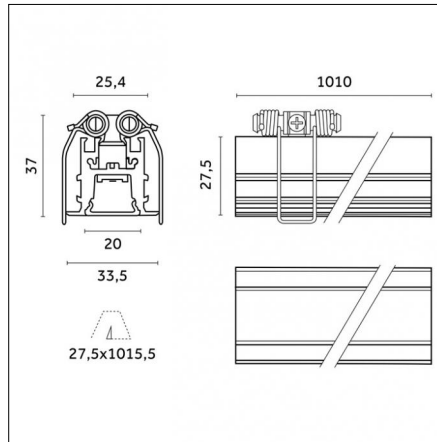
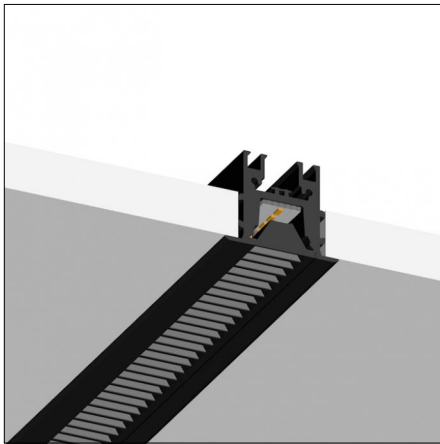

Very wide 60°/20°

31

IP40



850°



Code X.BN36G.HN31

Light source features

Number of light sources: 1

Source type: LED HN

Watt: 28W

Lm: 4100lm

Lm/W: 148lm/W

Kelvin/CRI: 4000K / >90

SDCM/L80 B10: < 3 / 50000

Fixture total output: 670 lm

Fixture efficacy: 21 lm/W

Electrical features

Driver included: NO

Driver position: remote

Driver type: no driver included 24V DC

Total power consumption (LED + DRIVER): 32W

Isolation class: Class III

Driver note: See wiring diagrams for configurations

Optical features

Beam angle: 60°/20°

Interchangeable optic (IOS): NO

UGR : < 14

Physical features

Material: Extruded aluminum

Diffusing screen: Dark Grid

Mounting: Recessed

Finishing: Embossed matt black (Standard)

Notes:

End caps not included, to be ordered separately

Luminaire constructed in conformity with Directives 2014/35/EU (LV), 2014/30/EU (EMC), 2009/125/EC (Ecodesign) with Regulations (EC) No 245/2009, (EU) No 347/2010 and (EU) 2015/1428 (for luminaires with fluorescent and metal halide lamps only), 2009/125/EC (Ecodesign) with Regulations (EU) No 1194/2012 and 2015/1428 (for LED luminaires only), 2011/65/EU (RoHS 2) and 2012/19/EU (WEEE).

Reggiani SPA Illuminazione

Viale Monza, 16 20845 Sovico (MB) Italy
Tel. (+39) 039 2071.1 fax (+39) 039 2071 999

www.reggiani.net
contact@reggiani.net

Driver

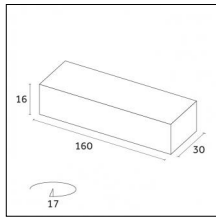

Code 0.30820.0000 - Driver

Type: On-Off
Watt: W - AC Input: 220-240Vac - mA:mA
Description:

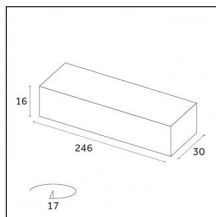

Code 0.30821.0000 - Driver

Type: On-Off
Watt: W - AC Input: 220-240Vac - mA:mA
Description:

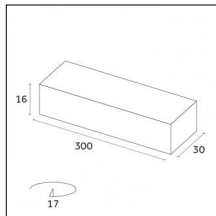

Code 0.30822.0000 - Driver

Type: On-Off
Watt: W - AC Input: 120-240V - mA:mA
Description:

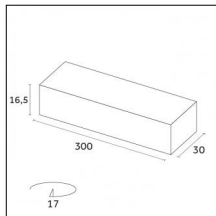

Code 0.30823.0000 - Driver

Type: On-Off
Watt: W - AC Input: 220-240Vac - mA:mA
Description:

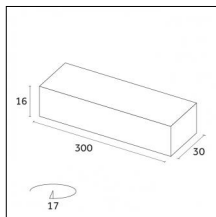

Code 0.30824.0000 - Driver

Type: On-Off
Watt: W - AC Input: 120-240V - mA:mA
Description:

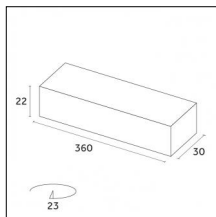

Code 0.30825.0000 - Driver

Type: On-Off
Watt: W - AC Input: 120-240V - mA:mA
Description:

Driver

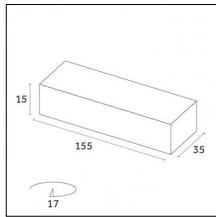

Code H.30826.0000 - Dimmer - 1 channel

Type: Bluetooth
Watt: W - AC Input: 24-48Vcc - mA:mA
Description:

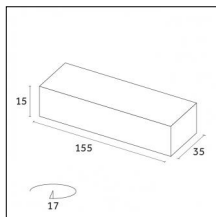

Code H.30827.0000 - Dimmer - 2 channels - for Tunable White

Type: Bluetooth
Watt: W - AC Input: 24-48Vcc - mA:mA
Description:

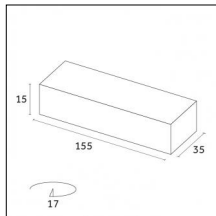

Code Y.30826.0000 - Dimmer -1 channel

Type: Dimmer 1-10V / DALI / PUSH
Watt: W - AC Input: 24-48Vcc - mA:mA
Description:

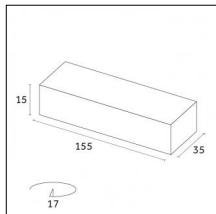

Code Y.30827.0000 - Dimmer - 2 channels - for Tunable White

Type: Dimmer 1-10V / DALI / PUSH
Watt: W - AC Input: 24-48Vcc - mA:mA
Description:

Accessories

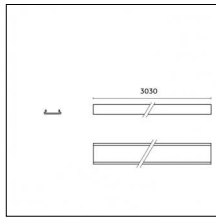
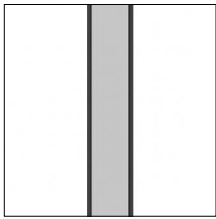

Code 0.26801.0000 - Opal Diffuser T 55% 3030mm

Type: Optical

Finishing: Without finish / Stainles Steel / Natural aluminium (Standard)

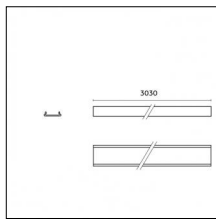
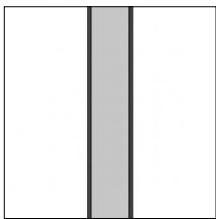

Code 0.26802.0000 - Opal Diffuser T 70% 3030mm

Type: Optical

Finishing: Without finish / Stainles Steel / Natural aluminium (Standard)

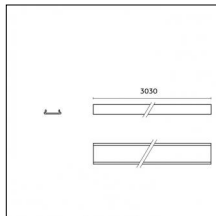
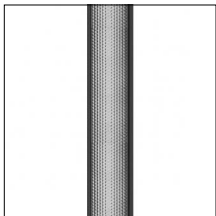

Code 0.26803.0000 - Micro Prismatic Diffuser Low Glare 3030mm

Type: Optical

Finishing: Without finish / Stainles Steel / Natural aluminium (Standard)

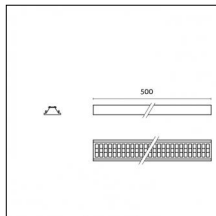
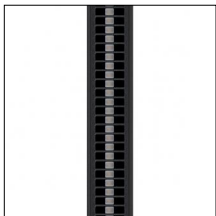

Code 0.26805.0000 - Dark Grid diffuser (UGR)

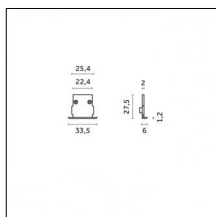
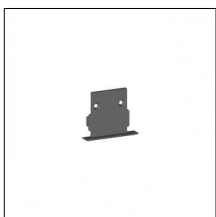

Code 0.26808.0001 - End caps (2x) Traceline Recessed Trim

Type: Mounting

Finishing: Chrome

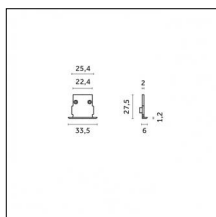
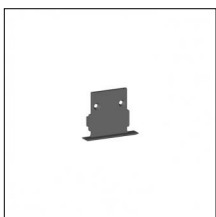

Code 0.26808.0012 - End caps (2x) Traceline Recessed Trim

Type: Mounting

Finishing: Embossed matt white (Standard)

Luminaire constructed in conformity with Directives 2014/35/EU (LV), 2014/30/EU (EMC), 2009/125/EC (Ecodesign) with Regulations (EC) No 245/2009, (EU) No 347/2010 and (EU) 2015/1428 (for luminaires with fluorescent and metal halide lamps only), 2009/125/EC (Ecodesign) with Regulations (EU) No 1194/2012 and 2015/1428 (for LED luminaires only), 2011/65/EU (RoHS 2) and 2012/19/EU (WEEE).

Accessories

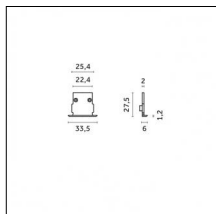
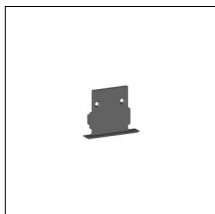

Code 0.26808.0031 - End caps (2x) Traceline Recessed Trim

Type: Mounting
Finishing: Embossed matt black (Standard)

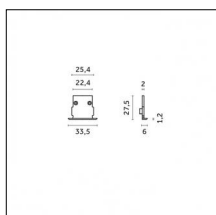
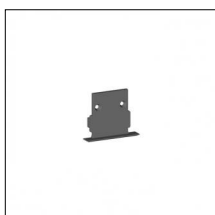

Code 0.26808.00B0 - End caps (2x) Traceline Recessed Trim

Type: Mounting
Finishing: Royal matt black

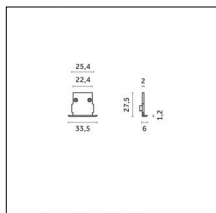
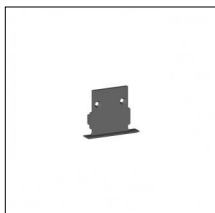

Code 0.26808.00C0 - End caps (2x) Traceline Recessed Trim

Type: Mounting
Finishing: Royal matt white

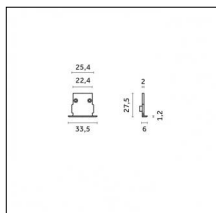
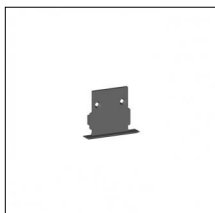

Code 0.26808.00D0 - End caps (2x) Traceline Recessed Trim

Type: Mounting
Finishing: Brushed brass

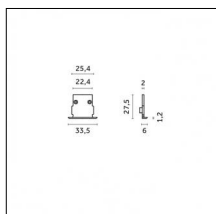
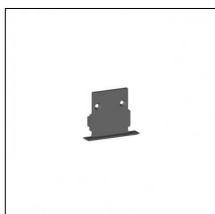

Code 0.26808.00E0 - End caps (2x) Traceline Recessed Trim

Type: Mounting
Finishing: Brushed gold

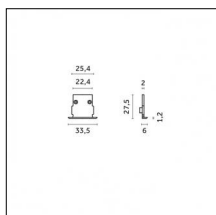
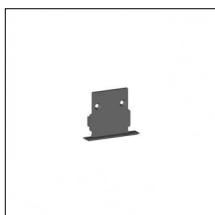

Code 0.26808.00L0 - End caps (2x) Traceline Recessed Trim

Type: Mounting
Finishing: Antiqued brushed bronze

Indoor | Recessed luminaires | Traceline Recessed

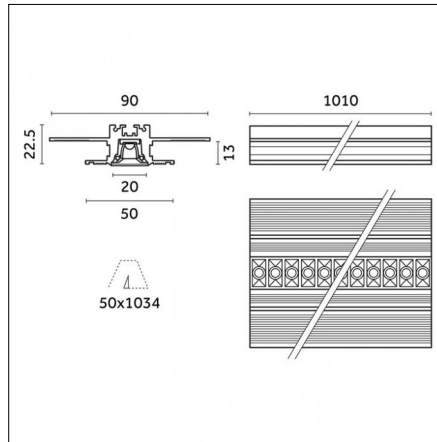
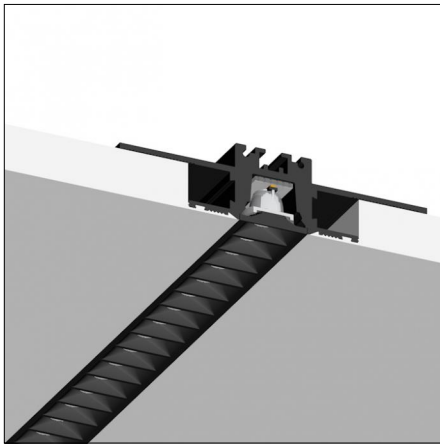

Very wide 40°

31

IP20



850°



Code X.CN55L.WQ31

Light source features

Number of light sources: 1

Source type: LED WQ

Watt: 21W

Lm: 3240lm

Lm/W: 159lm/W

Kelvin/CRI: 3500K / >90

SDCM/L80 B10: < 3 / 50000

Fixture total output: 2118 lm

Fixture efficacy: 88 lm/W

Electrical features

Driver included: NO

Driver position: remote

Driver type: no driver included 24V DC

Total power consumption (LED + DRIVER): 24W

Isolation class: Class III

Driver note: See wiring diagrams for configurations

Optical features

Beam angle: 40°

Interchangeable optic (IOS): NO

UGR : < 16

Physical features

Material: Extruded aluminum

Diffusing screen: Dark Performance

Mounting: Recessed

Finishing: Embossed matt black (Standard)

Notes:

End caps not included, to be ordered separately

Luminaire constructed in conformity with Directives 2014/35/EU (LV), 2014/30/EU (EMC), 2009/125/EC (Ecodesign) with Regulations (EC) No 245/2009, (EU) No 347/2010 and (EU) 2015/1428 (for luminaires with fluorescent and metal halide lamps only), 2009/125/EC (Ecodesign) with Regulations (EU) No 1194/2012 and 2015/1428 (for LED luminaires only), 2011/65/EU (RoHS 2) and 2012/19/EU (WEEE).

Reggiani SPA Illuminazione

Viale Monza, 16 20845 Sovico (MB) Italy
Tel. (+39) 039 2071.1 fax (+39) 039 2071 999

www.reggiani.net
contact@reggiani.net

Driver

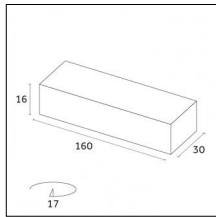

Code 0.30820.0000 - Driver

Type: On-Off
Watt: W - AC Input: 220-240Vac - mA:mA
Description:

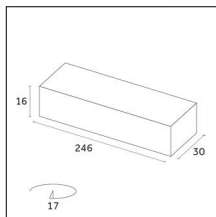

Code 0.30821.0000 - Driver

Type: On-Off
Watt: W - AC Input: 220-240Vac - mA:mA
Description:

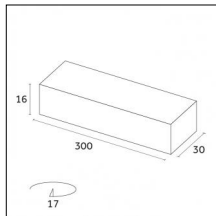

Code 0.30822.0000 - Driver

Type: On-Off
Watt: W - AC Input: 120-240V - mA:mA
Description:

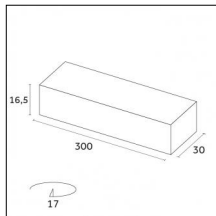

Code 0.30823.0000 - Driver

Type: On-Off
Watt: W - AC Input: 220-240Vac - mA:mA
Description:

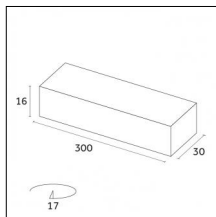

Code 0.30824.0000 - Driver

Type: On-Off
Watt: W - AC Input: 120-240V - mA:mA
Description:

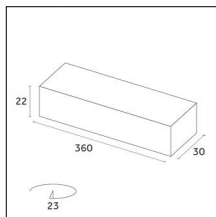

Code 0.30825.0000 - Driver

Type: On-Off
Watt: W - AC Input: 120-240V - mA:mA
Description:

Driver

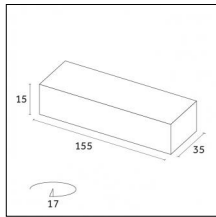

Code H.30826.0000 - Dimmer - 1 channel

Type: Bluetooth
Watt: W - AC Input: 24-48Vcc - mA:mA
Description:

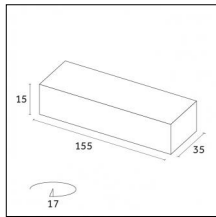

Code H.30827.0000 - Dimmer - 2 channels - for Tunable White

Type: Bluetooth
Watt: W - AC Input: 24-48Vcc - mA:mA
Description:

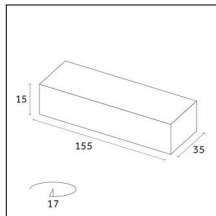

Code Y.30826.0000 - Dimmer -1 channel

Type: Dimmer 1-10V / DALI / PUSH
Watt: W - AC Input: 24-48Vcc - mA:mA
Description:

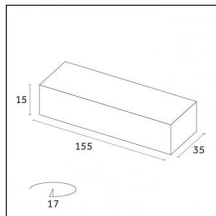

Code Y.30827.0000 - Dimmer - 2 channels - for Tunable White

Type: Dimmer 1-10V / DALI / PUSH
Watt: W - AC Input: 24-48Vcc - mA:mA
Description:

Accessories

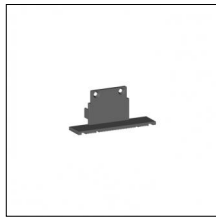
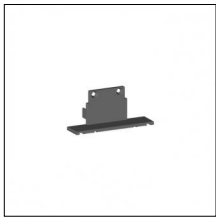

Code 0.26810.0001 - End caps (2x) Traceline Recessed Trimless

Type: Mounting
Finishing: Chrome

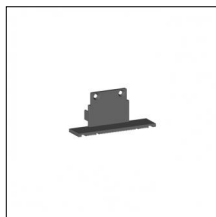
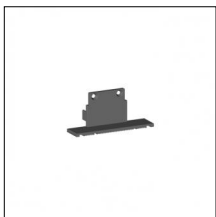

Code 0.26810.0012 - End caps (2x) Traceline Recessed Trimless

Type: Mounting
Finishing: Embossed matt white (Standard)

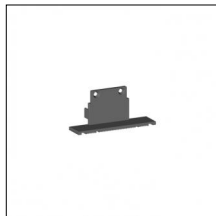
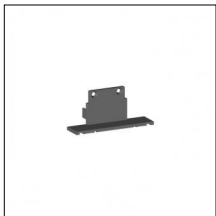

Code 0.26810.0031 - End caps (2x) Traceline Recessed Trimless

Type: Mounting
Finishing: Embossed matt black (Standard)

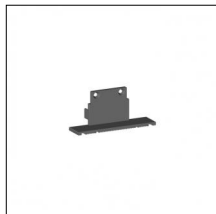

Code 0.26810.00B0 - End caps (2x) Traceline Recessed Trimless

Type: Mounting
Finishing: Royal matt black

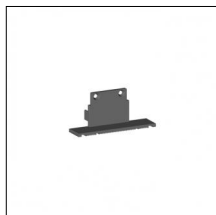

Code 0.26810.00C0 - End caps (2x) Traceline Recessed Trimless

Type: Mounting
Finishing: Royal matt white

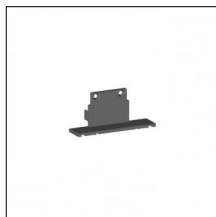
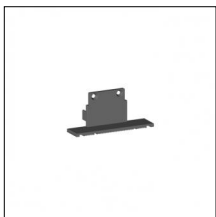

Code 0.26810.00D0 - End caps (2x) Traceline Recessed Trimless

Type: Mounting
Finishing: Brushed brass

Luminaire constructed in conformity with Directives 2014/35/EU (LV), 2014/30/EU (EMC), 2009/125/EC (Ecodesign) with Regulations (EC) No 245/2009, (EU) No 347/2010 and (EU) 2015/1428 (for luminaires with fluorescent and metal halide lamps only), 2009/125/EC (Ecodesign) with Regulations (EU) No 1194/2012 and 2015/1428 (for LED luminaires only), 2011/65/EU (RoHS 2) and 2012/19/EU (WEEE).

Accessories

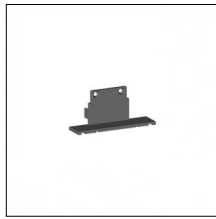
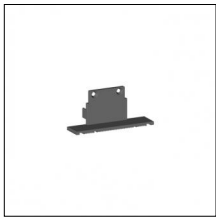

Code 0.26810.00E0 - End caps (2x) Traceline Recessed Trimless

Type: Mounting
Finishing: Brushed gold

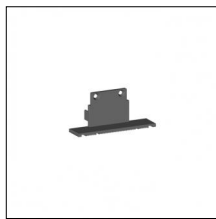

Code 0.26810.00L0 - End caps (2x) Traceline Recessed Trimless

Type: Mounting
Finishing: Antiqued brushed bronze

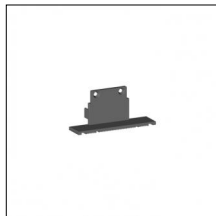
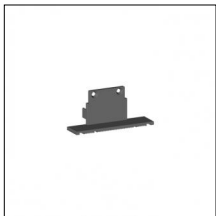

Code 0.26810.00M0 - End caps (2x) Traceline Recessed Trimless

Type: Mounting
Finishing: Brushed aluminum

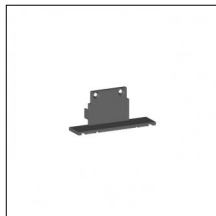
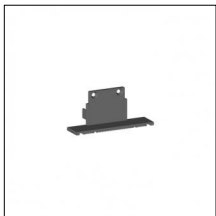

Code 0.26810.00N0 - End caps (2x) Traceline Recessed Trimless

Type: Mounting
Finishing: Brushed copper

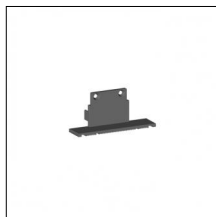
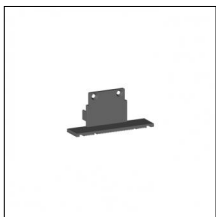

Code 0.26810.00T1 - End caps (2x) Traceline Recessed Trimless

Type: Mounting
Finishing: Anodized Bronze

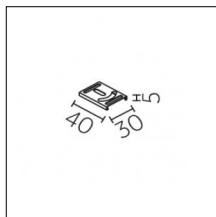

Code 0.26879.0000 - 3-way distributor - (1in - 2out)

Type: Electrical
Finishing: Without finish / Stainless Steel / Natural aluminium (Standard)
Description:

1in - 2out - 16A-250V

Polyamide body

Silver plated brass contacts

Luminaire constructed in conformity with Directives 2014/35/EU (LV), 2014/30/EU (EMC), 2009/125/EC (Ecodesign) with Regulations (EC) No 245/2009, (EU) No 347/2010 and (EU) 2015/1428 (for luminaires with fluorescent and metal halide lamps only), 2009/125/EC (Ecodesign) with Regulations (EU) No 1194/2012 and 2015/1428 (for LED luminaires only), 2011/65/EU (RoHS 2) and 2012/19/EU (WEEE).

Accessories

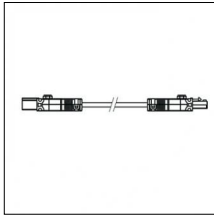

Code 0.26880.0000 - Plug to Socket with extension cable

Type: Electrical

Finishing: Without finish / Stainles Steel / Natural aluminium (Standard)

Description:

Extension cable multicore 1x2,5mm

16A-250V

Cable length 3000mm

Maximum capacity 84W/3m

Indoor | Recessed luminaires | Traceline Recessed

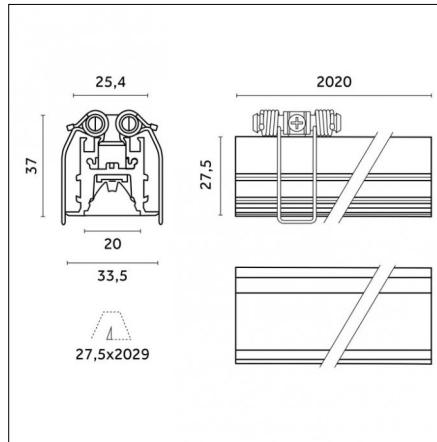
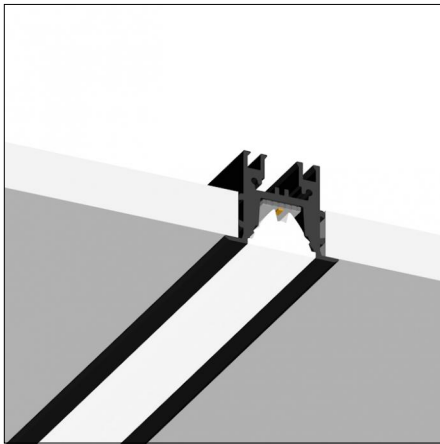

Narrow 11°

31

IP40



850°



Code X.BN3TB.HN31

Light source features

Number of light sources: 1

Source type: LED HN

Watt: 56W

Lm: 8200lm

Lm/W: 148lm/W

Kelvin/CRI: 4000K / >90

SDCM/L80 B10: < 3 / 50000

Fixture total output: 5397 lm

Fixture efficacy: 84 lm/W

Electrical features

Driver included: NO

Driver position: remote

Driver type: no driver included 24V DC

Total power consumption (LED + DRIVER): 64W

Isolation class: Class III

Driver note: See wiring diagrams for configurations

Optical features

Beam angle: 11°

Interchangeable optic (IOS): NO

Physical features

Material: Extruded aluminum

Diffusing screen: PMMA Lens 11°

Mounting: Recessed

Finishing: Embossed matt black (Standard)

Notes:

End caps not included, to be ordered separately

Luminaire constructed in conformity with Directives 2014/35/EU (LV), 2014/30/EU (EMC), 2009/125/EC (Ecodesign) with Regulations (EC) No 245/2009, (EU) No 347/2010 and (EU) 2015/1428 (for luminaires with fluorescent and metal halide lamps only), 2009/125/EC (Ecodesign) with Regulations (EU) No 1194/2012 and 2015/1428 (for LED luminaires only), 2011/65/EU (RoHS 2) and 2012/19/EU (WEEE).

Reggiani SPA Illuminazione

Viale Monza, 16 20845 Sovico (MB) Italy
Tel. (+39) 039 2071.1 fax (+39) 039 2071 999

www.reggiani.net
contact@reggiani.net

Driver

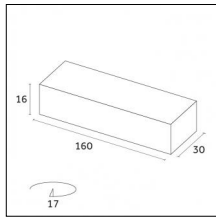

Code 0.30820.0000 - Driver

Type: On-Off
Watt: W - AC Input: 220-240Vac - mA:mA
Description:

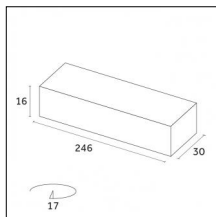

Code 0.30821.0000 - Driver

Type: On-Off
Watt: W - AC Input: 220-240Vac - mA:mA
Description:

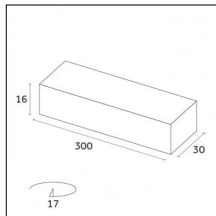

Code 0.30822.0000 - Driver

Type: On-Off
Watt: W - AC Input: 120-240V - mA:mA
Description:

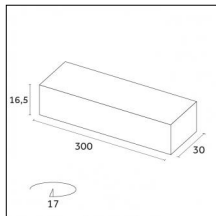

Code 0.30823.0000 - Driver

Type: On-Off
Watt: W - AC Input: 220-240Vac - mA:mA
Description:

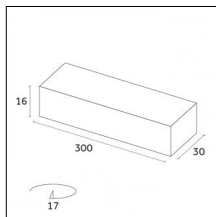

Code 0.30824.0000 - Driver

Type: On-Off
Watt: W - AC Input: 120-240V - mA:mA
Description:

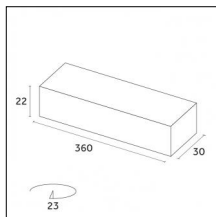

Code 0.30825.0000 - Driver

Type: On-Off
Watt: W - AC Input: 120-240V - mA:mA
Description:

Driver

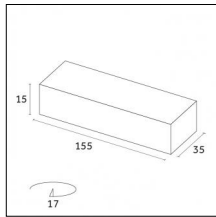

Code H.30826.0000 - Dimmer - 1 channel

Type: Bluetooth
Watt: W - AC Input: 24-48Vcc - mA:mA
Description:

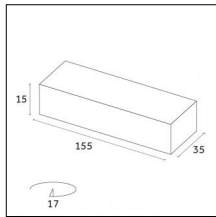

Code H.30827.0000 - Dimmer - 2 channels - for Tunable White

Type: Bluetooth
Watt: W - AC Input: 24-48Vcc - mA:mA
Description:

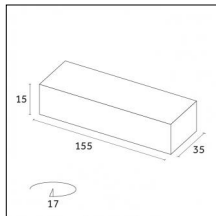

Code Y.30826.0000 - Dimmer -1 channel

Type: Dimmer 1-10V / DALI / PUSH
Watt: W - AC Input: 24-48Vcc - mA:mA
Description:

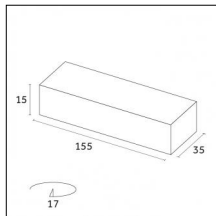

Code Y.30827.0000 - Dimmer - 2 channels - for Tunable White

Type: Dimmer 1-10V / DALI / PUSH
Watt: W - AC Input: 24-48Vcc - mA:mA
Description:

Accessories

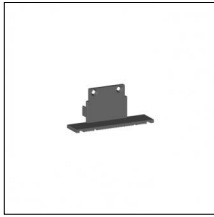
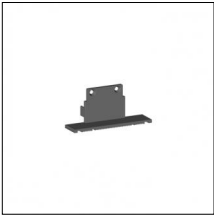

Code 0.26810.0001 - End caps (2x) Traceline Recessed Trimless

Type: Mounting
Finishing: Chrome

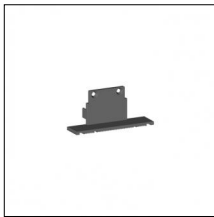

Code 0.26810.0012 - End caps (2x) Traceline Recessed Trimless

Type: Mounting
Finishing: Embossed matt white (Standard)

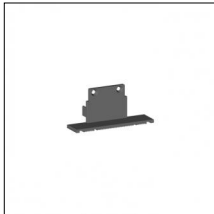

Code 0.26810.0031 - End caps (2x) Traceline Recessed Trimless

Type: Mounting
Finishing: Embossed matt black (Standard)

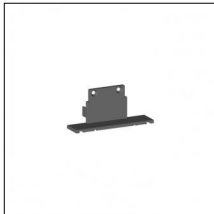

Code 0.26810.00B0 - End caps (2x) Traceline Recessed Trimless

Type: Mounting
Finishing: Royal matt black

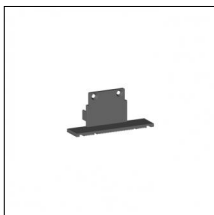

Code 0.26810.00C0 - End caps (2x) Traceline Recessed Trimless

Type: Mounting
Finishing: Royal matt white

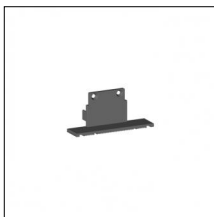
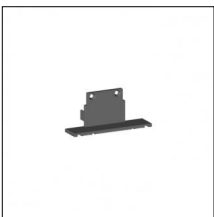

Code 0.26810.00D0 - End caps (2x) Traceline Recessed Trimless

Type: Mounting
Finishing: Brushed brass

Luminaire constructed in conformity with Directives 2014/35/EU (LV), 2014/30/EU (EMC), 2009/125/EC (Ecodesign) with Regulations (EC) No 245/2009, (EU) No 347/2010 and (EU) 2015/1428 (for luminaires with fluorescent and metal halide lamps only), 2009/125/EC (Ecodesign) with Regulations (EU) No 1194/2012 and 2015/1428 (for LED luminaires only), 2011/65/EU (RoHS 2) and 2012/19/EU (WEEE).

Accessories

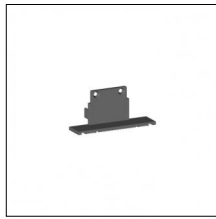
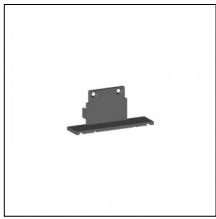

Code 0.26810.00E0 - End caps (2x) Traceline Recessed Trimless

Type: Mounting
Finishing: Brushed gold

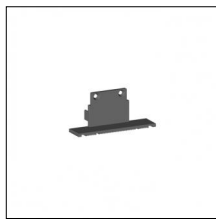

Code 0.26810.00L0 - End caps (2x) Traceline Recessed Trimless

Type: Mounting
Finishing: Antiqued brushed bronze

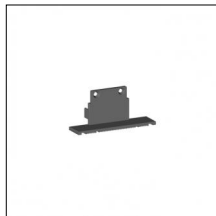
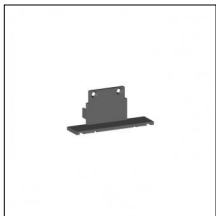

Code 0.26810.00M0 - End caps (2x) Traceline Recessed Trimless

Type: Mounting
Finishing: Brushed aluminum

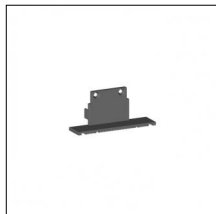
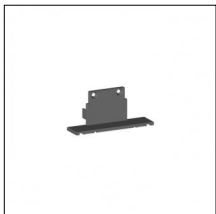

Code 0.26810.00N0 - End caps (2x) Traceline Recessed Trimless

Type: Mounting
Finishing: Brushed copper

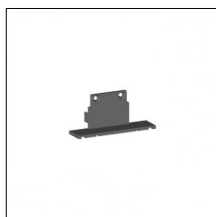
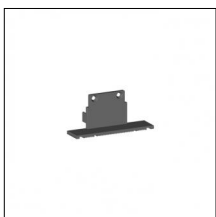

Code 0.26810.00T1 - End caps (2x) Traceline Recessed Trimless

Type: Mounting
Finishing: Anodized Bronze

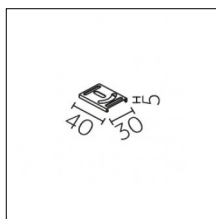

Code 0.26879.0000 - 3-way distributor - (1in - 2out)

Type: Electrical
Finishing: Without finish / Stainless Steel / Natural aluminium (Standard)
Description:

1in - 2out - 16A-250V

Polyamide body

Silver plated brass contacts

Luminaire constructed in conformity with Directives 2014/35/EU (LV), 2014/30/EU (EMC), 2009/125/EC (Ecodesign) with Regulations (EC) No 245/2009, (EU) No 347/2010 and (EU) 2015/1428 (for luminaires with fluorescent and metal halide lamps only), 2009/125/EC (Ecodesign) with Regulations (EU) No 1194/2012 and 2015/1428 (for LED luminaires only), 2011/65/EU (RoHS 2) and 2012/19/EU (WEEE).

Accessories

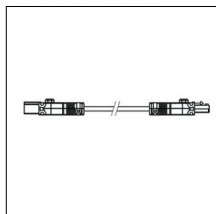

Code 0.26880.0000 - Plug to Socket with extension cable

Type: Electrical

Finishing: Without finish / Stainles Steel / Natural aluminium (Standard)

Description:

Extension cable multicore 1x2,5mm

16A-250V

Cable length 3000mm

Maximum capacity 84W/3m

Indoor | Recessed luminaires | Traceline Recessed

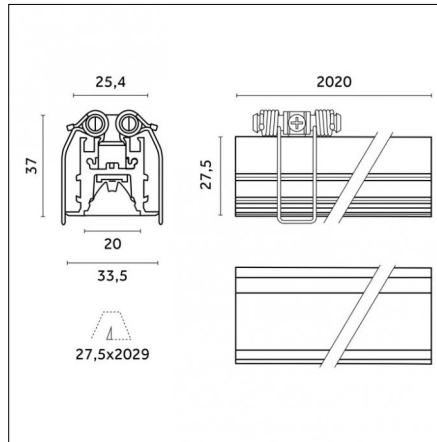
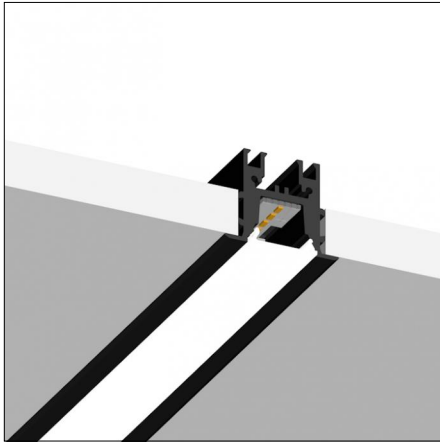

Narrow 11°

01

IP40



850°



Code X.BN37H.HN01

Light source features

Number of light sources: 1

Source type: LED HN

Watt: 14.6W

Lm: 2344lm

Lm/W: 160lm/W

Kelvin/CRI: 4000K / >90

SDCM/L80 B10: < 3 / 50000

Fixture total output: 1315 lm

Fixture efficacy: 77 lm/W

Electrical features

Driver included: NO

Driver position: remote

Driver type: no driver included 24V DC

Total power consumption (LED + DRIVER): 17W

Isolation class: Class III

Driver note: See wiring diagrams for configurations

Optical features

Beam angle: 11°

Interchangeable optic (IOS): NO

Physical features

Material: Extruded aluminum

Diffusing screen: Opal

Mounting: Recessed

Finishing: Chrome

Notes:

End caps not included, to be ordered separately

Luminaire constructed in conformity with Directives 2014/35/EU (LV), 2014/30/EU (EMC), 2009/125/EC (Ecodesign) with Regulations (EC) No 245/2009, (EU) No 347/2010 and (EU) 2015/1428 (for luminaires with fluorescent and metal halide lamps only), 2009/125/EC (Ecodesign) with Regulations (EU) No 1194/2012 and 2015/1428 (for LED luminaires only), 2011/65/EU (RoHS 2) and 2012/19/EU (WEEE).

Reggiani SPA Illuminazione

Viale Monza, 16 20845 Sovico (MB) Italy
Tel. (+39) 039 2071.1 fax (+39) 039 2071 999

www.reggiani.net
contact@reggiani.net

Driver

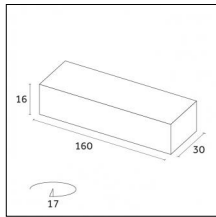

Code 0.30820.0000 - Driver

Type: On-Off
Watt: W - AC Input: 220-240Vac - mA:mA
Description:

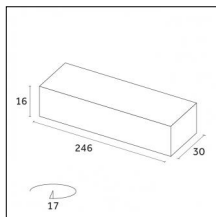

Code 0.30821.0000 - Driver

Type: On-Off
Watt: W - AC Input: 220-240Vac - mA:mA
Description:

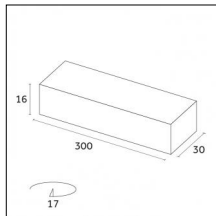

Code 0.30822.0000 - Driver

Type: On-Off
Watt: W - AC Input: 120-240V - mA:mA
Description:

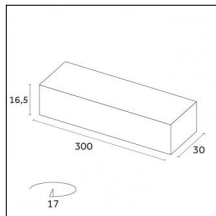

Code 0.30823.0000 - Driver

Type: On-Off
Watt: W - AC Input: 220-240Vac - mA:mA
Description:

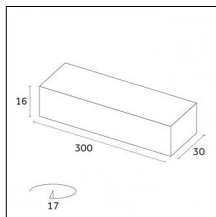

Code 0.30824.0000 - Driver

Type: On-Off
Watt: W - AC Input: 120-240V - mA:mA
Description:

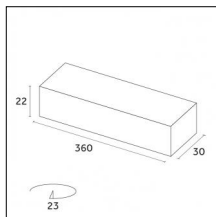

Code 0.30825.0000 - Driver

Type: On-Off
Watt: W - AC Input: 120-240V - mA:mA
Description:

Driver

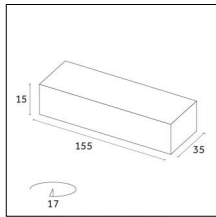

Code H.30826.0000 - Dimmer - 1 channel

Type: Bluetooth
Watt: W - AC Input: 24-48Vcc - mA:mA
Description:

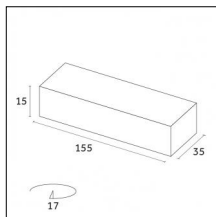

Code H.30827.0000 - Dimmer - 2 channels - for Tunable White

Type: Bluetooth
Watt: W - AC Input: 24-48Vcc - mA:mA
Description:

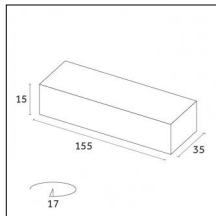

Code Y.30826.0000 - Dimmer -1 channel

Type: Dimmer 1-10V / DALI / PUSH
Watt: W - AC Input: 24-48Vcc - mA:mA
Description:

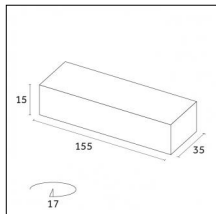

Code Y.30827.0000 - Dimmer - 2 channels - for Tunable White

Type: Dimmer 1-10V / DALI / PUSH
Watt: W - AC Input: 24-48Vcc - mA:mA
Description:

Accessories

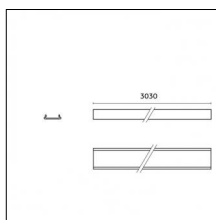
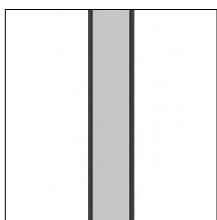

Code 0.26802.0000 - Opal Diffuser T 70% 3030mm

Type: Optical

Finishing: Without finish / Stainles Steel / Natural aluminium (Standard)

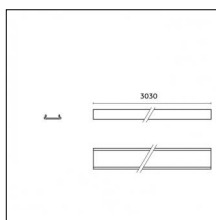
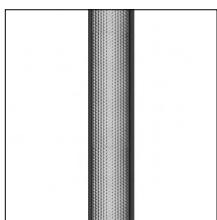

Code 0.26803.0000 - Micro Prismatic Diffuser Low Glare 3030mm

Type: Optical

Finishing: Without finish / Stainles Steel / Natural aluminium (Standard)

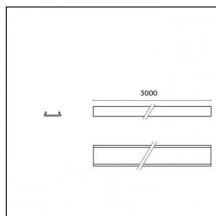
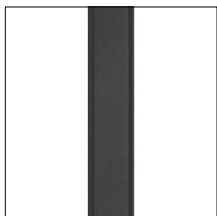

Code 0.26804.0000 - Black Frosted diffuser L3030mm

Type: Optical

Finishing: Without finish / Stainles Steel / Natural aluminium (Standard)

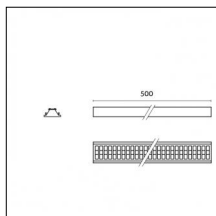
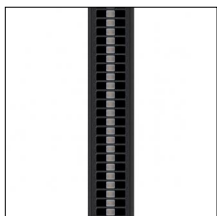

Code 0.26805.0000 - Dark Grid diffuser (UGR)

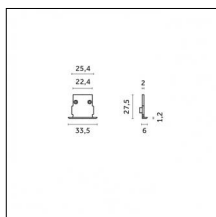
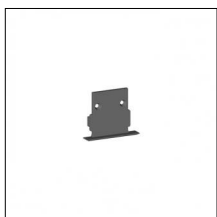

Code 0.26808.0001 - End caps (2x) Traceline Recessed Trim

Type: Mounting

Finishing: Chrome

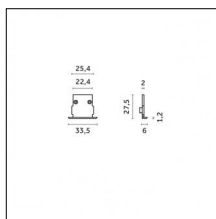
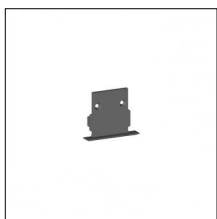

Code 0.26808.0012 - End caps (2x) Traceline Recessed Trim

Type: Mounting

Finishing: Embossed matt white (Standard)

Luminaire constructed in conformity with Directives 2014/35/EU (LV), 2014/30/EU (EMC), 2009/125/EC (Ecodesign) with Regulations (EC) No 245/2009, (EU) No 347/2010 and (EU) 2015/1428 (for luminaires with fluorescent and metal halide lamps only), 2009/125/EC (Ecodesign) with Regulations (EU) No 1194/2012 and 2015/1428 (for LED luminaires only), 2011/65/EU (RoHS 2) and 2012/19/EU (WEEE).

Accessories

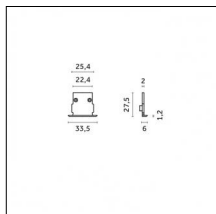
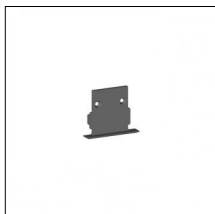

Code 0.26808.0031 - End caps (2x) Traceline Recessed Trim

Type: Mounting
Finishing: Embossed matt black (Standard)

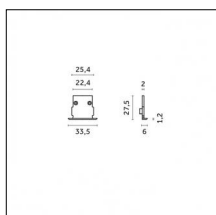
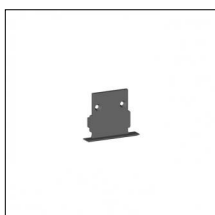

Code 0.26808.00B0 - End caps (2x) Traceline Recessed Trim

Type: Mounting
Finishing: Royal matt black

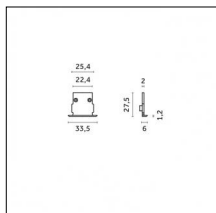
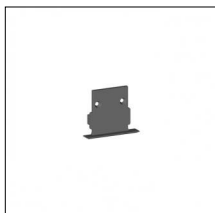

Code 0.26808.00C0 - End caps (2x) Traceline Recessed Trim

Type: Mounting
Finishing: Royal matt white

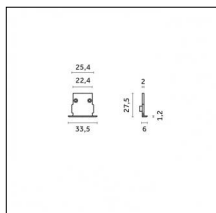
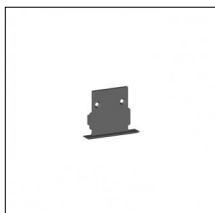

Code 0.26808.00D0 - End caps (2x) Traceline Recessed Trim

Type: Mounting
Finishing: Brushed brass

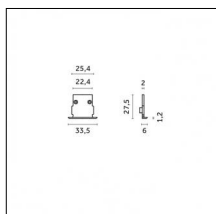
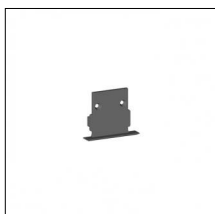

Code 0.26808.00E0 - End caps (2x) Traceline Recessed Trim

Type: Mounting
Finishing: Brushed gold

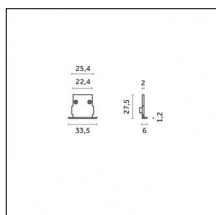
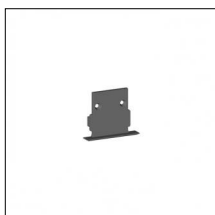

Code 0.26808.00L0 - End caps (2x) Traceline Recessed Trim

Type: Mounting
Finishing: Antiqued brushed bronze

Accessories

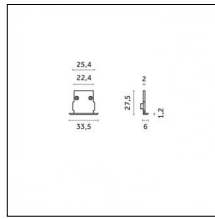
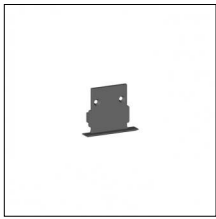

Code 0.26808.00M0 - End caps (2x) Traceline Recessed Trim

Type: Mounting
Finishing: Brushed aluminum

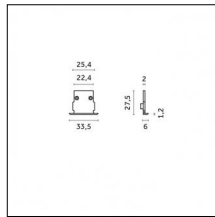
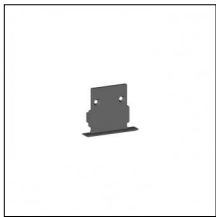

Code 0.26808.00N0 - End caps (2x) Traceline Recessed Trim

Type: Mounting
Finishing: Brushed copper

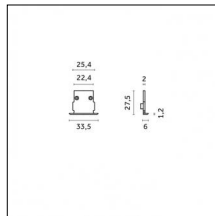
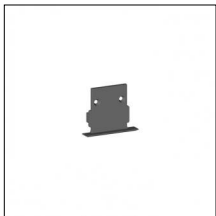

Code 0.26808.00T1 - End caps (2x) Traceline Recessed Trim

Type: Mounting
Finishing: Anodized Bronze

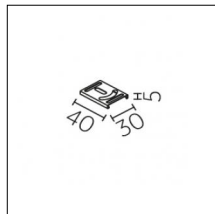

Code 0.26879.0000 - 3-way distributor - (1in - 2out)

Type: Electrical
Finishing: Without finish / Stainles Steel / Natural aluminium (Standard)
Description:

1in - 2out - 16A-250V

Polyamide body

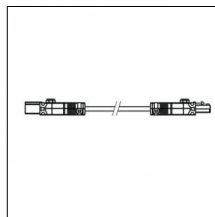

Code 0.26880.0000 - Plug to Socket with extension cable

Type: Electrical
Finishing: Without finish / Stainles Steel / Natural aluminium (Standard)
Description:

Extension cable multicore 1x2,5mm

16A-250V

Cable length 3000mm

Maximum capacity 84W/3m

Indoor | Recessed luminaires | Traceline Recessed

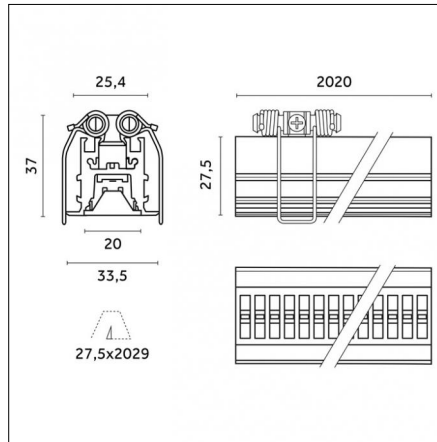
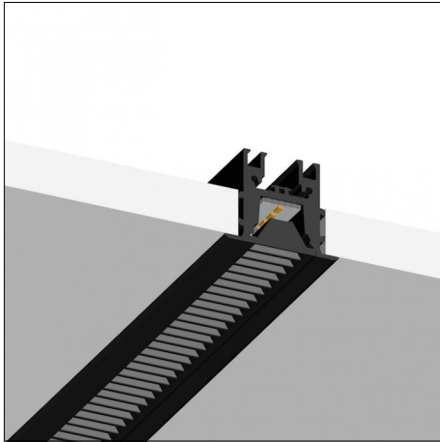

Very wide 60°/20°

01

IP20



850°



Code X.BN3TG.HN01

Light source features

Number of light sources: 1

Source type: LED HN

Watt: 56W

Lm: 8200lm

Lm/W: 148lm/W

Kelvin/CRI: 4000K / >90

SDCM/L80 B10: < 3 / 50000

Fixture total output: 1340 lm

Fixture efficacy: 21 lm/W

Electrical features

Driver included: NO

Driver position: remote

Driver type: no driver included 24V DC

Total power consumption (LED + DRIVER): 64W

Isolation class: Class III

Driver note: See wiring diagrams for configurations

Optical features

Beam angle: 60°/20°

Interchangeable optic (IOS): NO

UGR : < 14

Physical features

Material: Extruded aluminum

Diffusing screen: Dark Grid

Mounting: Recessed

Finishing: Chrome

Notes:

End caps not included, to be ordered separately

Luminaire constructed in conformity with Directives 2014/35/EU (LV), 2014/30/EU (EMC), 2009/125/EC (Ecodesign) with Regulations (EC) No 245/2009, (EU) No 347/2010 and (EU) 2015/1428 (for luminaires with fluorescent and metal halide lamps only), 2009/125/EC (Ecodesign) with Regulations (EU) No 1194/2012 and 2015/1428 (for LED luminaires only), 2011/65/EU (RoHS 2) and 2012/19/EU (WEEE).

Reggiani SPA Illuminazione

Viale Monza, 16 20845 Sovico (MB) Italy
Tel. (+39) 039 2071.1 fax (+39) 039 2071 999

www.reggiani.net
contact@reggiani.net

Driver

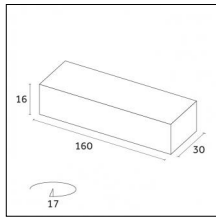

Code 0.30820.0000 - Driver

Type: On-Off
Watt: W - AC Input: 220-240Vac - mA:mA
Description:

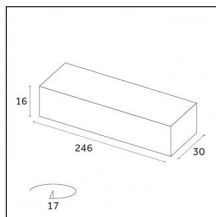

Code 0.30821.0000 - Driver

Type: On-Off
Watt: W - AC Input: 220-240Vac - mA:mA
Description:

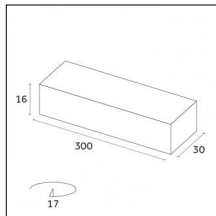

Code 0.30822.0000 - Driver

Type: On-Off
Watt: W - AC Input: 120-240V - mA:mA
Description:

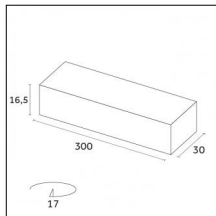

Code 0.30823.0000 - Driver

Type: On-Off
Watt: W - AC Input: 220-240Vac - mA:mA
Description:

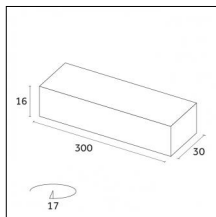

Code 0.30824.0000 - Driver

Type: On-Off
Watt: W - AC Input: 120-240V - mA:mA
Description:

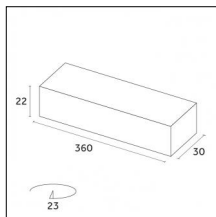

Code 0.30825.0000 - Driver

Type: On-Off
Watt: W - AC Input: 120-240V - mA:mA
Description:

Driver

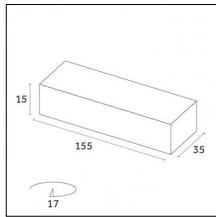

Code H.30826.0000 - Dimmer - 1 channel

Type: Bluetooth
Watt: W - AC Input: 24-48Vcc - mA:mA
Description:

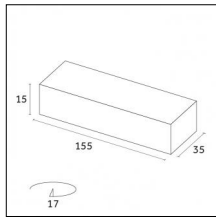

Code H.30827.0000 - Dimmer - 2 channels - for Tunable White

Type: Bluetooth
Watt: W - AC Input: 24-48Vcc - mA:mA
Description:

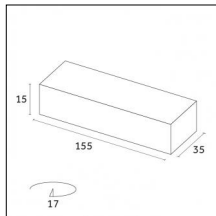

Code Y.30826.0000 - Dimmer -1 channel

Type: Dimmer 1-10V / DALI / PUSH
Watt: W - AC Input: 24-48Vcc - mA:mA
Description:

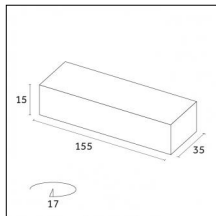

Code Y.30827.0000 - Dimmer - 2 channels - for Tunable White

Type: Dimmer 1-10V / DALI / PUSH
Watt: W - AC Input: 24-48Vcc - mA:mA
Description:

Accessories

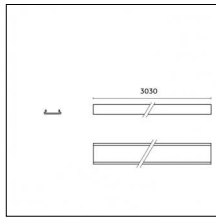
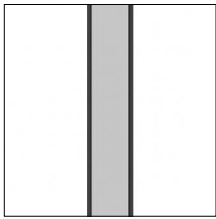

Code 0.26801.0000 - Opal Diffuser T 55% 3030mm

Type: Optical

Finishing: Without finish / Stainles Steel / Natural aluminium (Standard)

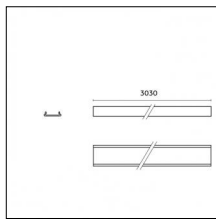
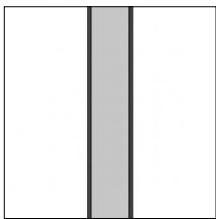

Code 0.26802.0000 - Opal Diffuser T 70% 3030mm

Type: Optical

Finishing: Without finish / Stainles Steel / Natural aluminium (Standard)

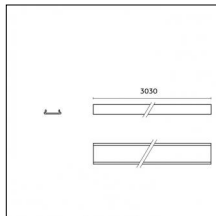
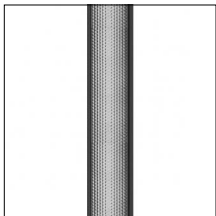

Code 0.26803.0000 - Micro Prismatic Diffuser Low Glare 3030mm

Type: Optical

Finishing: Without finish / Stainles Steel / Natural aluminium (Standard)

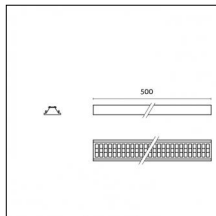
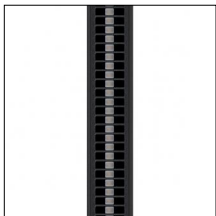

Code 0.26805.0000 - Dark Grid diffuser (UGR)

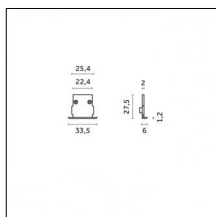
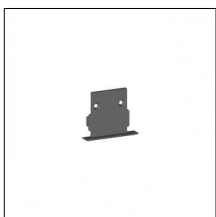

Code 0.26808.0001 - End caps (2x) Traceline Recessed Trim

Type: Mounting

Finishing: Chrome

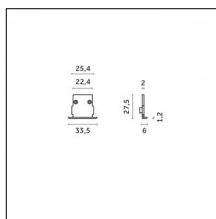
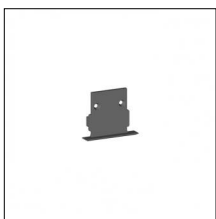

Code 0.26808.0012 - End caps (2x) Traceline Recessed Trim

Type: Mounting

Finishing: Embossed matt white (Standard)

Luminaire constructed in conformity with Directives 2014/35/EU (LV), 2014/30/EU (EMC), 2009/125/EC (Ecodesign) with Regulations (EC) No 245/2009, (EU) No 347/2010 and (EU) 2015/1428 (for luminaires with fluorescent and metal halide lamps only), 2009/125/EC (Ecodesign) with Regulations (EU) No 1194/2012 and 2015/1428 (for LED luminaires only), 2011/65/EU (RoHS 2) and 2012/19/EU (WEEE).

Accessories

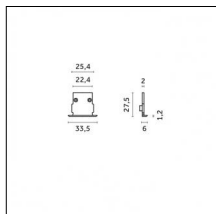
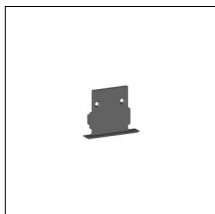

Code 0.26808.0031 - End caps (2x) Traceline Recessed Trim

Type: Mounting
Finishing: Embossed matt black (Standard)

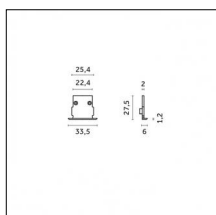
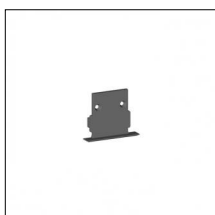

Code 0.26808.00B0 - End caps (2x) Traceline Recessed Trim

Type: Mounting
Finishing: Royal matt black

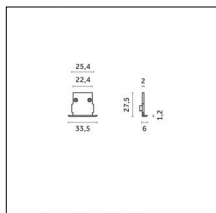
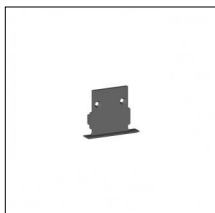

Code 0.26808.00C0 - End caps (2x) Traceline Recessed Trim

Type: Mounting
Finishing: Royal matt white

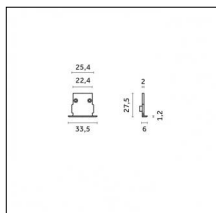
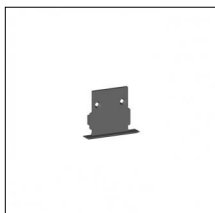

Code 0.26808.00D0 - End caps (2x) Traceline Recessed Trim

Type: Mounting
Finishing: Brushed brass

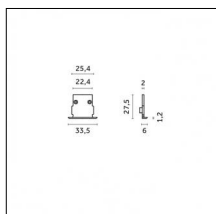
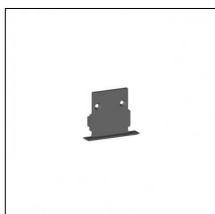

Code 0.26808.00E0 - End caps (2x) Traceline Recessed Trim

Type: Mounting
Finishing: Brushed gold

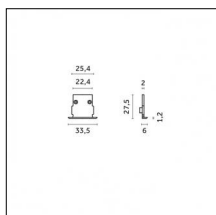
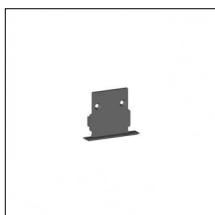

Code 0.26808.00L0 - End caps (2x) Traceline Recessed Trim

Type: Mounting
Finishing: Antiqued brushed bronze

Accessories

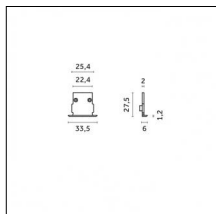
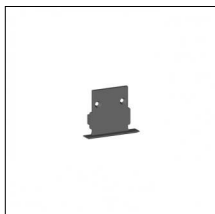

Code 0.26808.00M0 - End caps (2x) Traceline Recessed Trim

Type: Mounting
Finishing: Brushed aluminum

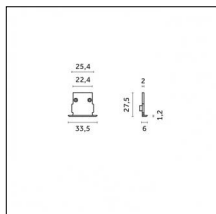
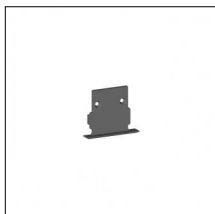

Code 0.26808.00N0 - End caps (2x) Traceline Recessed Trim

Type: Mounting
Finishing: Brushed copper

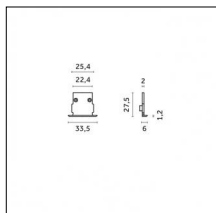
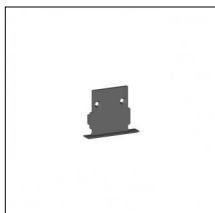

Code 0.26808.00T1 - End caps (2x) Traceline Recessed Trim

Type: Mounting
Finishing: Anodized Bronze

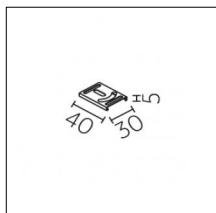

Code 0.26879.0000 - 3-way distributor - (1in - 2out)

Type: Electrical
Finishing: Without finish / Stainles Steel / Natural aluminium (Standard)
Description:

1in - 2out - 16A-250V

Polyamide body

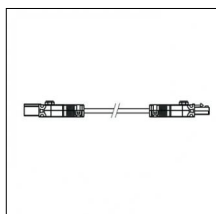

Code 0.26880.0000 - Plug to Socket with extension cable

Type: Electrical
Finishing: Without finish / Stainles Steel / Natural aluminium (Standard)
Description:

Extension cable multicore 1x2,5mm

16A-250V

Cable length 3000mm

Maximum capacity 84W/3m

Indoor | Recessed luminaires | Traceline Recessed

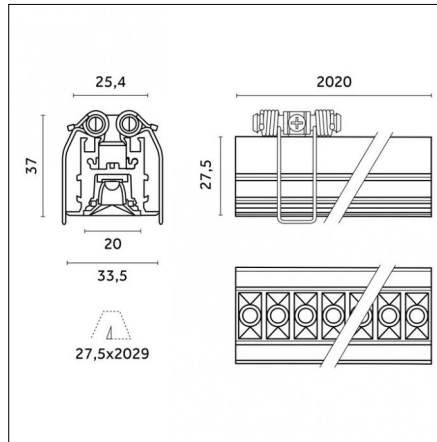
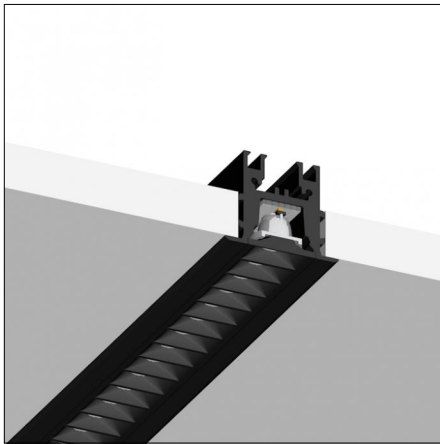

Very wide 40°

01

IP20



850°



Code X.CN39L.HC01

Light source features

Number of light sources: 1

Source type: LED HC

Watt: 42W

Lm: 5824lm

Lm/W: 143lm/W

Kelvin/CRI: 3000K / >95

SDCM/L80 B10: < 3 / 50000

Fixture total output: 3815 lm

Fixture efficacy: 79 lm/W

Electrical features

Driver included: NO

Driver position: remote

Driver type: no driver included 24V DC

Total power consumption (LED + DRIVER): 48W

Isolation class: Class III

Driver note: See wiring diagrams for configurations

Optical features

Beam angle: 40°

Interchangeable optic (IOS): NO

UGR : < 16

Physical features

Material: Extruded aluminum

Diffusing screen: Dark Performance

Mounting: Recessed

Finishing: Chrome

Notes:

End caps not included, to be ordered separately

Luminaire constructed in conformity with Directives 2014/35/EU (LV), 2014/30/EU (EMC), 2009/125/EC (Ecodesign) with Regulations (EC) No 245/2009, (EU) No 347/2010 and (EU) 2015/1428 (for luminaires with fluorescent and metal halide lamps only), 2009/125/EC (Ecodesign) with Regulations (EU) No 1194/2012 and 2015/1428 (for LED luminaires only), 2011/65/EU (RoHS 2) and 2012/19/EU (WEEE).

Reggiani SPA Illuminazione

Viale Monza, 16 20845 Sovico (MB) Italy
Tel. (+39) 039 2071.1 fax (+39) 039 2071 999

www.reggiani.net
contact@reggiani.net

Driver

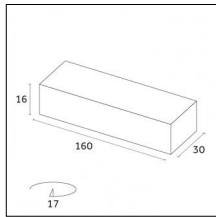

Code 0.30820.0000 - Driver

Type: On-Off
Watt: W - AC Input: 220-240Vac - mA:mA
Description:

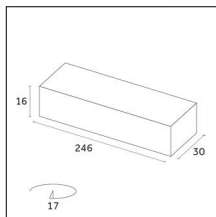

Code 0.30821.0000 - Driver

Type: On-Off
Watt: W - AC Input: 220-240Vac - mA:mA
Description:

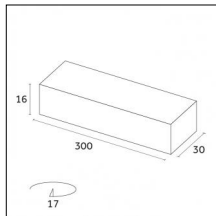

Code 0.30822.0000 - Driver

Type: On-Off
Watt: W - AC Input: 120-240V - mA:mA
Description:

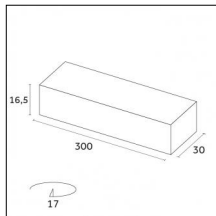

Code 0.30823.0000 - Driver

Type: On-Off
Watt: W - AC Input: 220-240Vac - mA:mA
Description:

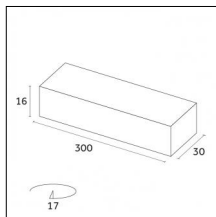

Code 0.30824.0000 - Driver

Type: On-Off
Watt: W - AC Input: 120-240V - mA:mA
Description:

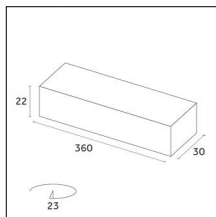

Code 0.30825.0000 - Driver

Type: On-Off
Watt: W - AC Input: 120-240V - mA:mA
Description:

Driver

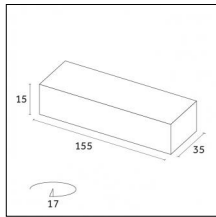

Code H.30826.0000 - Dimmer - 1 channel

Type: Bluetooth
Watt: W - AC Input: 24-48Vcc - mA:mA
Description:

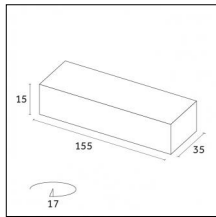

Code H.30827.0000 - Dimmer - 2 channels - for Tunable White

Type: Bluetooth
Watt: W - AC Input: 24-48Vcc - mA:mA
Description:

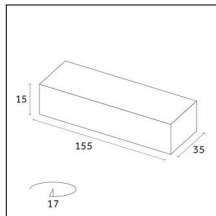

Code Y.30826.0000 - Dimmer -1 channel

Type: Dimmer 1-10V / DALI / PUSH
Watt: W - AC Input: 24-48Vcc - mA:mA
Description:

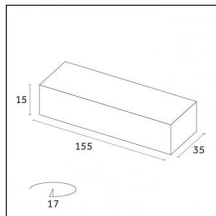

Code Y.30827.0000 - Dimmer - 2 channels - for Tunable White

Type: Dimmer 1-10V / DALI / PUSH
Watt: W - AC Input: 24-48Vcc - mA:mA
Description:

Accessories

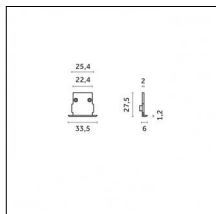
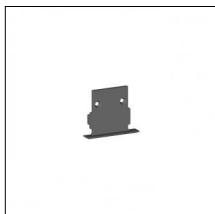

Code 0.26808.0001 - End caps (2x) Traceline Recessed Trim

Type: Mounting
Finishing: Chrome

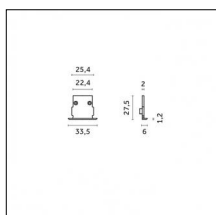
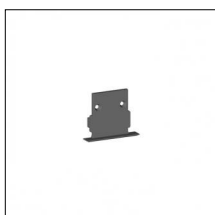

Code 0.26808.0012 - End caps (2x) Traceline Recessed Trim

Type: Mounting
Finishing: Embossed matt white (Standard)

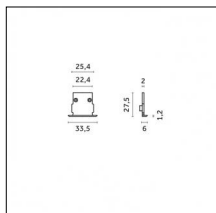
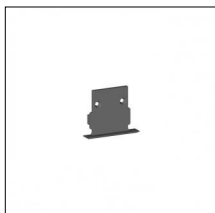

Code 0.26808.0031 - End caps (2x) Traceline Recessed Trim

Type: Mounting
Finishing: Embossed matt black (Standard)

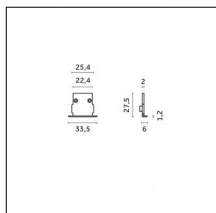
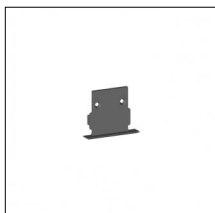

Code 0.26808.00B0 - End caps (2x) Traceline Recessed Trim

Type: Mounting
Finishing: Royal matt black

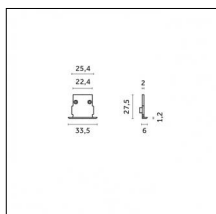
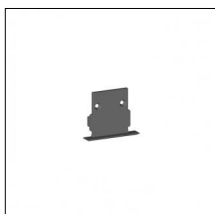

Code 0.26808.00C0 - End caps (2x) Traceline Recessed Trim

Type: Mounting
Finishing: Royal matt white

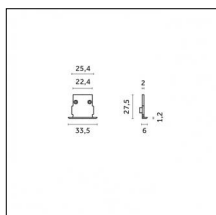
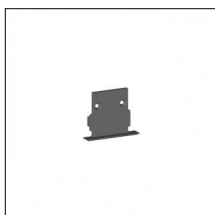

Code 0.26808.00D0 - End caps (2x) Traceline Recessed Trim

Type: Mounting
Finishing: Brushed brass

Luminaire constructed in conformity with Directives 2014/35/EU (LV), 2014/30/EU (EMC), 2009/125/EC (Ecodesign) with Regulations (EC) No 245/2009, (EU) No 347/2010 and (EU) 2015/1428 (for luminaires with fluorescent and metal halide lamps only), 2009/125/EC (Ecodesign) with Regulations (EU) No 1194/2012 and 2015/1428 (for LED luminaires only), 2011/65/EU (RoHS 2) and 2012/19/EU (WEEE).

Accessories

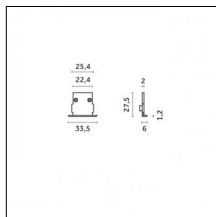
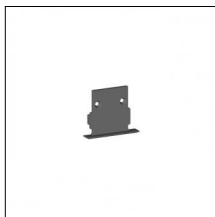

Code 0.26808.00E0 - End caps (2x) Traceline Recessed Trim

Type: Mounting
Finishing: Brushed gold

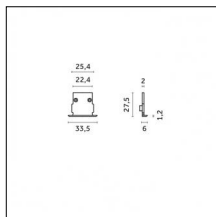
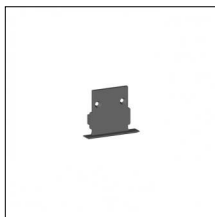

Code 0.26808.00L0 - End caps (2x) Traceline Recessed Trim

Type: Mounting
Finishing: Antiqued brushed bronze

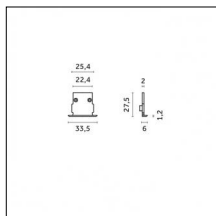
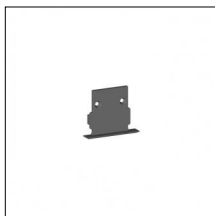

Code 0.26808.00M0 - End caps (2x) Traceline Recessed Trim

Type: Mounting
Finishing: Brushed aluminum

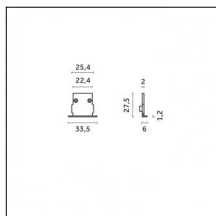
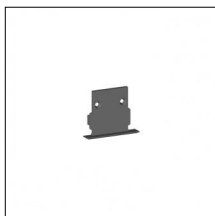

Code 0.26808.00N0 - End caps (2x) Traceline Recessed Trim

Type: Mounting
Finishing: Brushed copper

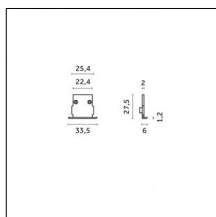
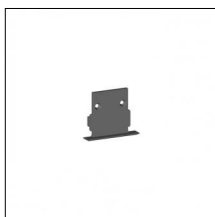

Code 0.26808.00T1 - End caps (2x) Traceline Recessed Trim

Type: Mounting
Finishing: Anodized Bronze

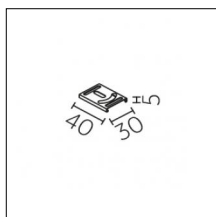

Code 0.26879.0000 - 3-way distributor - (1in - 2out)

Type: Electrical
Finishing: Without finish / Stainles Steel / Natural aluminium (Standard)
Description:

1in - 2out - 16A-250V

Polyamide body

Silver plated brass contacts

Luminaire constructed in conformity with Directives 2014/35/EU (LV), 2014/30/EU (EMC), 2009/125/EC (Ecodesign) with Regulations (EC) No 245/2009, (EU) No 347/2010 and (EU) 2015/1428 (for luminaires with fluorescent and metal halide lamps only), 2009/125/EC (Ecodesign) with Regulations (EU) No 1194/2012 and 2015/1428 (for LED luminaires only), 2011/65/EU (RoHS 2) and 2012/19/EU (WEEE).

Accessories

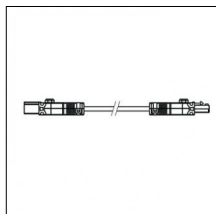

Code 0.26880.0000 - Plug to Socket with extension cable

Type: Electrical

Finishing: Without finish / Stainles Steel / Natural aluminium (Standard)

Description:

Extension cable multicore 1x2,5mm

16A-250V

Cable length 3000mm

Maximum capacity 84W/3m

Indoor | Recessed luminaires | Traceline Recessed

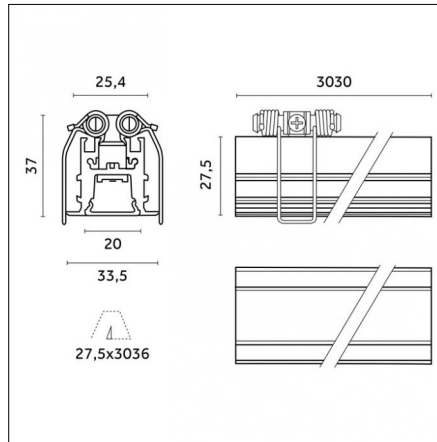
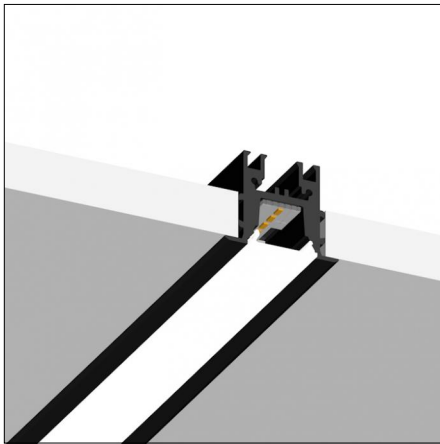

Very wide 110°

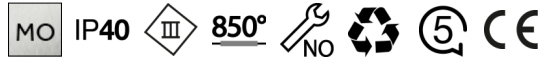

Code X.BN38H.HQM0

Light source features

Number of light sources: 1

Source type: LED HQ

Watt: 21.9W

Lm: 3060lm

Lm/W: 140lm/W

Kelvin/CRI: 3000K / >90

SDCM/L80 B10: < 3 / 50000

Fixture total output: 1717 lm

Fixture efficacy: 70 lm/W

Electrical features

Driver included: NO

Driver position: remote

Driver type: no driver included 24V DC

Total power consumption (LED + DRIVER): 24.5W

Isolation class: Class III

Driver note: See wiring diagrams for configurations

Optical features

Beam angle: 110°

Interchangeable optic (IOS): NO

Physical features

Material: Extruded aluminum

Diffusing screen: Opal

Mounting: Recessed

Finishing: Brushed aluminum

Notes:

End caps not included, to be ordered separately

Luminaire constructed in conformity with Directives 2014/35/EU (LV), 2014/30/EU (EMC), 2009/125/EC (Ecodesign) with Regulations (EC) No 245/2009, (EU) No 347/2010 and (EU) 2015/1428 (for luminaires with fluorescent and metal halide lamps only), 2009/125/EC (Ecodesign) with Regulations (EU) No 1194/2012 and 2015/1428 (for LED luminaires only), 2011/65/EU (RoHS 2) and 2012/19/EU (WEEE).

Reggiani SPA Illuminazione

Viale Monza, 16 20845 Sovico (MB) Italy
Tel. (+39) 039 2071.1 fax (+39) 039 2071 999

www.reggiani.net
contact@reggiani.net

Driver

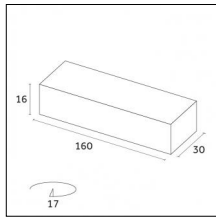

Code 0.30820.0000 - Driver

Type: On-Off
Watt: W - AC Input: 220-240Vac - mA:mA
Description:

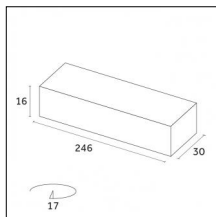

Code 0.30821.0000 - Driver

Type: On-Off
Watt: W - AC Input: 220-240Vac - mA:mA
Description:

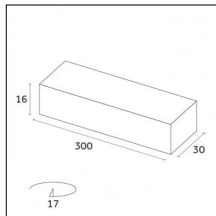

Code 0.30822.0000 - Driver

Type: On-Off
Watt: W - AC Input: 120-240V - mA:mA
Description:

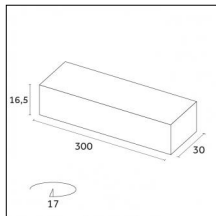

Code 0.30823.0000 - Driver

Type: On-Off
Watt: W - AC Input: 220-240Vac - mA:mA
Description:

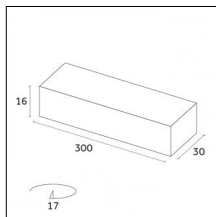

Code 0.30824.0000 - Driver

Type: On-Off
Watt: W - AC Input: 120-240V - mA:mA
Description:

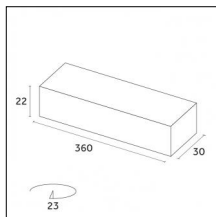

Code 0.30825.0000 - Driver

Type: On-Off
Watt: W - AC Input: 120-240V - mA:mA
Description:

Driver

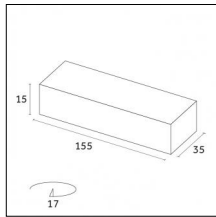

Code H.30826.0000 - Dimmer - 1 channel

Type: Bluetooth
Watt: W - AC Input: 24-48Vcc - mA:mA
Description:

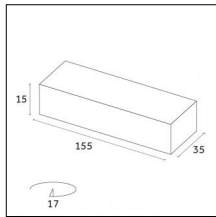

Code H.30827.0000 - Dimmer - 2 channels - for Tunable White

Type: Bluetooth
Watt: W - AC Input: 24-48Vcc - mA:mA
Description:

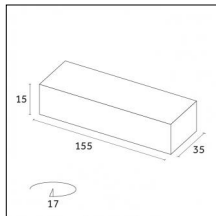

Code Y.30826.0000 - Dimmer -1 channel

Type: Dimmer 1-10V / DALI / PUSH
Watt: W - AC Input: 24-48Vcc - mA:mA
Description:

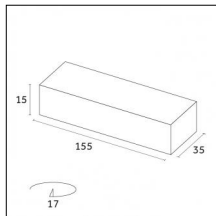

Code Y.30827.0000 - Dimmer - 2 channels - for Tunable White

Type: Dimmer 1-10V / DALI / PUSH
Watt: W - AC Input: 24-48Vcc - mA:mA
Description:

Accessories

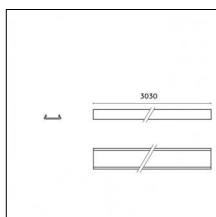
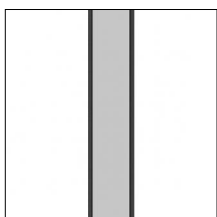

Code 0.26802.0000 - Opal Diffuser T 70% 3030mm

Type: Optical

Finishing: Without finish / Stainles Steel / Natural aluminium (Standard)

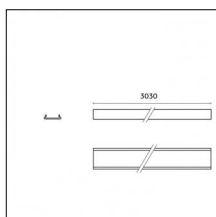
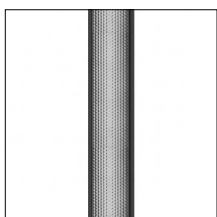

Code 0.26803.0000 - Micro Prismatic Diffuser Low Glare 3030mm

Type: Optical

Finishing: Without finish / Stainles Steel / Natural aluminium (Standard)

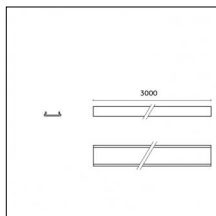
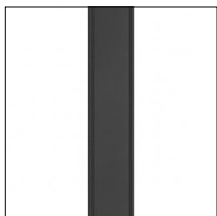

Code 0.26804.0000 - Black Frosted diffuser L3030mm

Type: Optical

Finishing: Without finish / Stainles Steel / Natural aluminium (Standard)

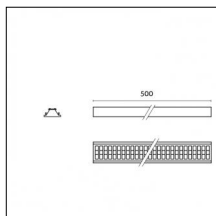
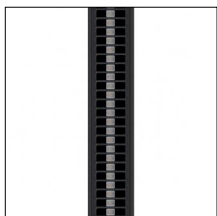

Code 0.26805.0000 - Dark Grid diffuser (UGR)

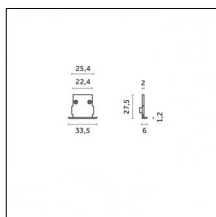
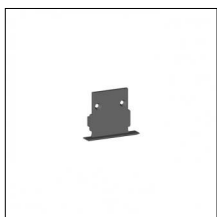

Code 0.26808.0001 - End caps (2x) Traceline Recessed Trim

Type: Mounting

Finishing: Chrome

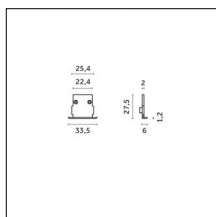
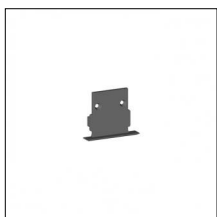

Code 0.26808.0012 - End caps (2x) Traceline Recessed Trim

Type: Mounting

Finishing: Embossed matt white (Standard)

Luminaire constructed in conformity with Directives 2014/35/EU (LV), 2014/30/EU (EMC), 2009/125/EC (Ecodesign) with Regulations (EC) No 245/2009, (EU) No 347/2010 and (EU) 2015/1428 (for luminaires with fluorescent and metal halide lamps only), 2009/125/EC (Ecodesign) with Regulations (EU) No 1194/2012 and 2015/1428 (for LED luminaires only), 2011/65/EU (RoHS 2) and 2012/19/EU (WEEE).

Accessories

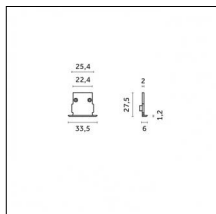
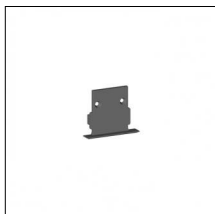

Code 0.26808.0031 - End caps (2x) Traceline Recessed Trim

Type: Mounting
Finishing: Embossed matt black (Standard)

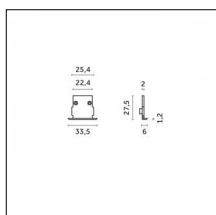
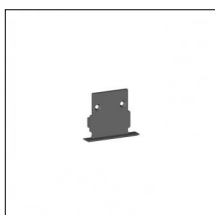

Code 0.26808.00B0 - End caps (2x) Traceline Recessed Trim

Type: Mounting
Finishing: Royal matt black

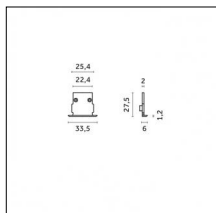
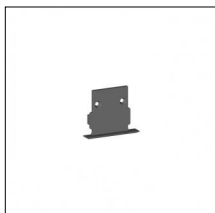

Code 0.26808.00C0 - End caps (2x) Traceline Recessed Trim

Type: Mounting
Finishing: Royal matt white

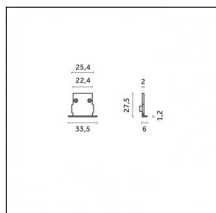
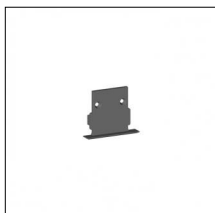

Code 0.26808.00D0 - End caps (2x) Traceline Recessed Trim

Type: Mounting
Finishing: Brushed brass

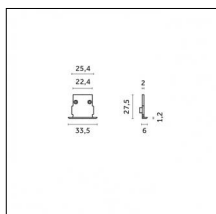
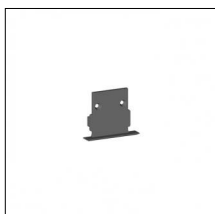

Code 0.26808.00E0 - End caps (2x) Traceline Recessed Trim

Type: Mounting
Finishing: Brushed gold

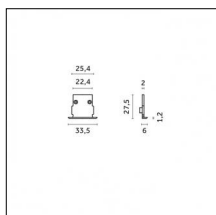
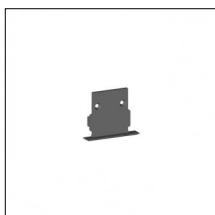

Code 0.26808.00L0 - End caps (2x) Traceline Recessed Trim

Type: Mounting
Finishing: Antiqued brushed bronze

Accessories

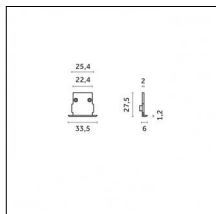
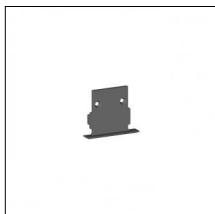

Code 0.26808.00M0 - End caps (2x) Traceline Recessed Trim

Type: Mounting
Finishing: Brushed aluminum

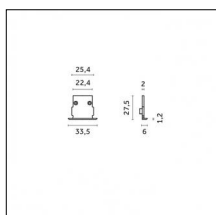
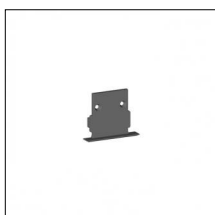

Code 0.26808.00N0 - End caps (2x) Traceline Recessed Trim

Type: Mounting
Finishing: Brushed copper

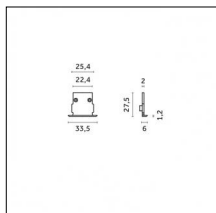
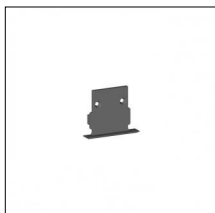

Code 0.26808.00T1 - End caps (2x) Traceline Recessed Trim

Type: Mounting
Finishing: Anodized Bronze

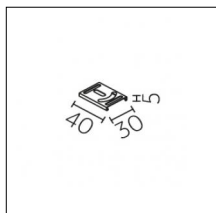

Code 0.26879.0000 - 3-way distributor - (1in - 2out)

Type: Electrical
Finishing: Without finish / Stainles Steel / Natural aluminium (Standard)
Description:

1in - 2out - 16A-250V

Polyamide body

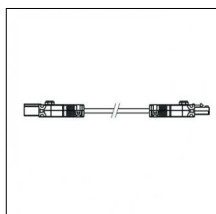

Code 0.26880.0000 - Plug to Socket with extension cable

Type: Electrical
Finishing: Without finish / Stainles Steel / Natural aluminium (Standard)
Description:

Extension cable multicore 1x2,5mm

16A-250V

Cable length 3000mm

Maximum capacity 84W/3m

Indoor | Recessed luminaires | Traceline Recessed

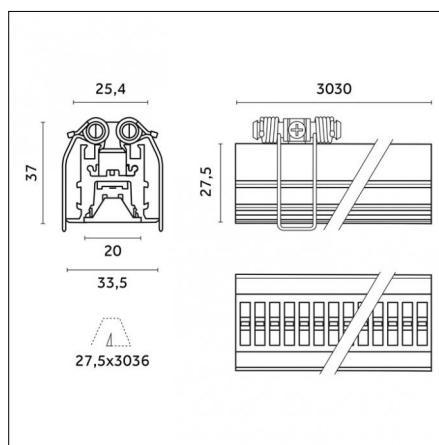
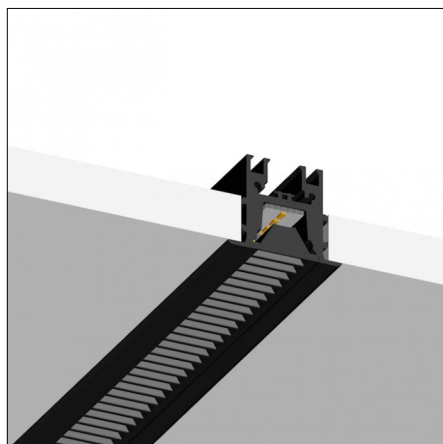

Very wide 60°/20°

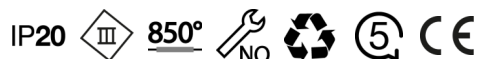

Code X.BN3UG.HNT1

Light source features

Number of light sources: 1

Source type: LED HN

Watt: 84W

Lm: 12300lm

Lm/W: 148lm/W

Kelvin/CRI: 4000K / >90

SDCM/L80 B10: < 3 / 50000

Fixture total output: 2010 lm

Fixture efficacy: 21 lm/W

Electrical features

Driver included: NO

Driver position: remote

Driver type: no driver included 24V DC

Total power consumption (LED + DRIVER): 96W

Isolation class: Class III

Driver note: See wiring diagrams for configurations

Optical features

Beam angle: 60°/20°

Interchangeable optic (IOS): NO

UGR : < 14

Physical features

Material: Extruded aluminum

Diffusing screen: Dark Grid

Mounting: Recessed

Finishing: Anodized Bronze

Notes:

End caps not included, to be ordered separately

Luminaire constructed in conformity with Directives 2014/35/EU (LV), 2014/30/EU (EMC), 2009/125/EC (Ecodesign) with Regulations (EC) No 245/2009, (EU) No 347/2010 and (EU) 2015/1428 (for luminaires with fluorescent and metal halide lamps only), 2009/125/EC (Ecodesign) with Regulations (EU) No 1194/2012 and 2015/1428 (for LED luminaires only), 2011/65/EU (RoHS 2) and 2012/19/EU (WEEE).

Reggiani SPA Illuminazione

Viale Monza, 16 20845 Sovico (MB) Italy
Tel. (+39) 039 2071.1 fax (+39) 039 2071 999

www.reggiani.net
contact@reggiani.net

Driver

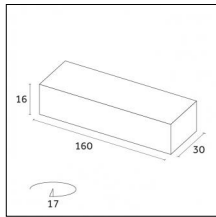

Code 0.30820.0000 - Driver

Type: On-Off
Watt: W - AC Input: 220-240Vac - mA:mA
Description:

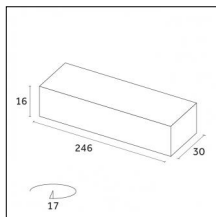

Code 0.30821.0000 - Driver

Type: On-Off
Watt: W - AC Input: 220-240Vac - mA:mA
Description:

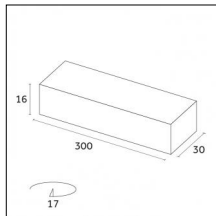

Code 0.30822.0000 - Driver

Type: On-Off
Watt: W - AC Input: 120-240V - mA:mA
Description:

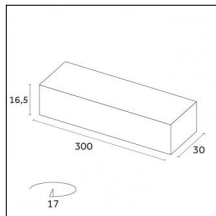

Code 0.30823.0000 - Driver

Type: On-Off
Watt: W - AC Input: 220-240Vac - mA:mA
Description:

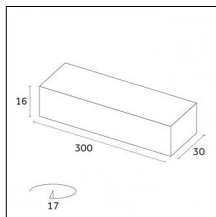

Code 0.30824.0000 - Driver

Type: On-Off
Watt: W - AC Input: 120-240V - mA:mA
Description:

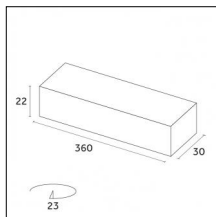

Code 0.30825.0000 - Driver

Type: On-Off
Watt: W - AC Input: 120-240V - mA:mA
Description:

Driver

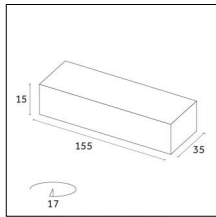

Code H.30826.0000 - Dimmer - 1 channel

Type: Bluetooth
Watt: W - AC Input: 24-48Vcc - mA:mA
Description:

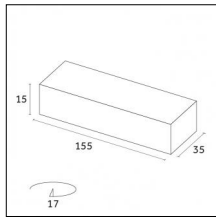

Code H.30827.0000 - Dimmer - 2 channels - for Tunable White

Type: Bluetooth
Watt: W - AC Input: 24-48Vcc - mA:mA
Description:

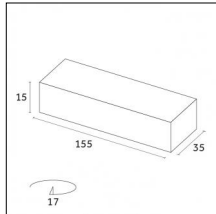

Code Y.30826.0000 - Dimmer -1 channel

Type: Dimmer 1-10V / DALI / PUSH
Watt: W - AC Input: 24-48Vcc - mA:mA
Description:

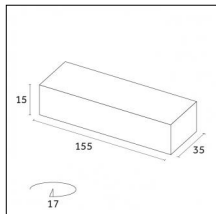

Code Y.30827.0000 - Dimmer - 2 channels - for Tunable White

Type: Dimmer 1-10V / DALI / PUSH
Watt: W - AC Input: 24-48Vcc - mA:mA
Description:

Accessories

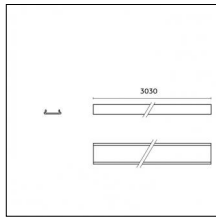
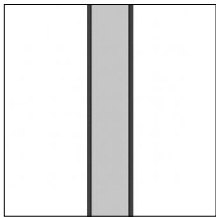

Code 0.26801.0000 - Opal Diffuser T 55% 3030mm

Type: Optical

Finishing: Without finish / Stainles Steel / Natural aluminium (Standard)

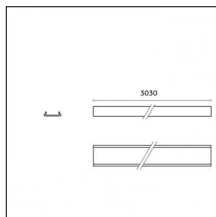
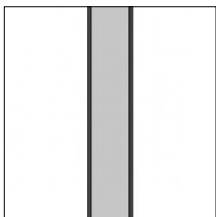

Code 0.26802.0000 - Opal Diffuser T 70% 3030mm

Type: Optical

Finishing: Without finish / Stainles Steel / Natural aluminium (Standard)

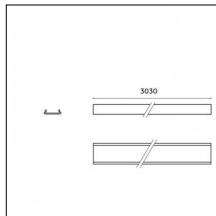
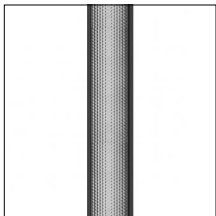

Code 0.26803.0000 - Micro Prismatic Diffuser Low Glare 3030mm

Type: Optical

Finishing: Without finish / Stainles Steel / Natural aluminium (Standard)

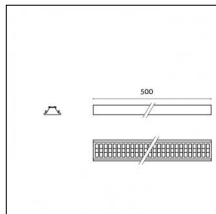
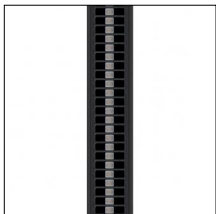

Code 0.26805.0000 - Dark Grid diffuser (UGR)

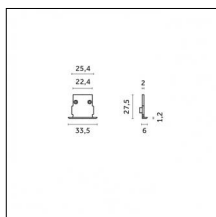
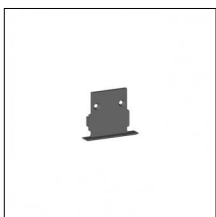

Code 0.26808.0001 - End caps (2x) Traceline Recessed Trim

Type: Mounting

Finishing: Chrome

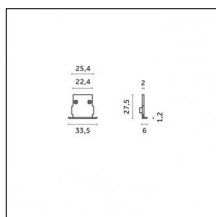
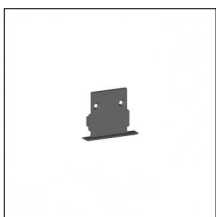

Code 0.26808.0012 - End caps (2x) Traceline Recessed Trim

Type: Mounting

Finishing: Embossed matt white (Standard)

Luminaire constructed in conformity with Directives 2014/35/EU (LV), 2014/30/EU (EMC), 2009/125/EC (Ecodesign) with Regulations (EC) No 245/2009, (EU) No 347/2010 and (EU) 2015/1428 (for luminaires with fluorescent and metal halide lamps only), 2009/125/EC (Ecodesign) with Regulations (EU) No 1194/2012 and 2015/1428 (for LED luminaires only), 2011/65/EU (RoHS 2) and 2012/19/EU (WEEE).

Accessories

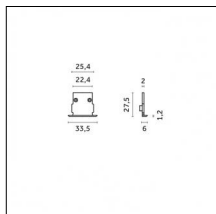
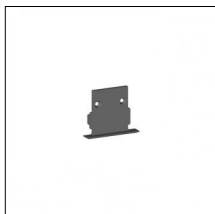

Code 0.26808.0031 - End caps (2x) Traceline Recessed Trim

Type: Mounting
Finishing: Embossed matt black (Standard)

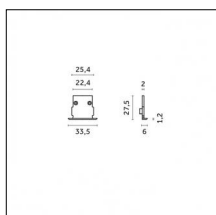
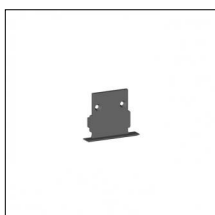

Code 0.26808.00B0 - End caps (2x) Traceline Recessed Trim

Type: Mounting
Finishing: Royal matt black

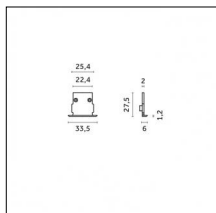
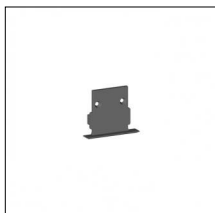

Code 0.26808.00C0 - End caps (2x) Traceline Recessed Trim

Type: Mounting
Finishing: Royal matt white

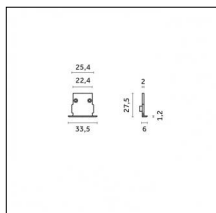
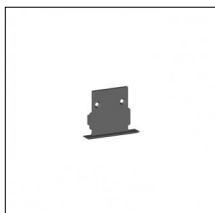

Code 0.26808.00D0 - End caps (2x) Traceline Recessed Trim

Type: Mounting
Finishing: Brushed brass

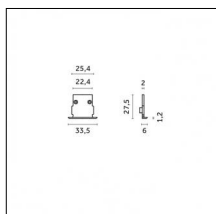
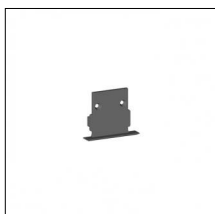

Code 0.26808.00E0 - End caps (2x) Traceline Recessed Trim

Type: Mounting
Finishing: Brushed gold

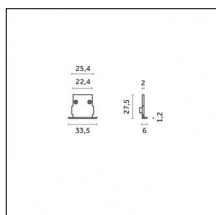
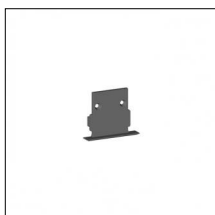

Code 0.26808.00L0 - End caps (2x) Traceline Recessed Trim

Type: Mounting
Finishing: Antiqued brushed bronze

Indoor | Recessed luminaires | Traceline Recessed

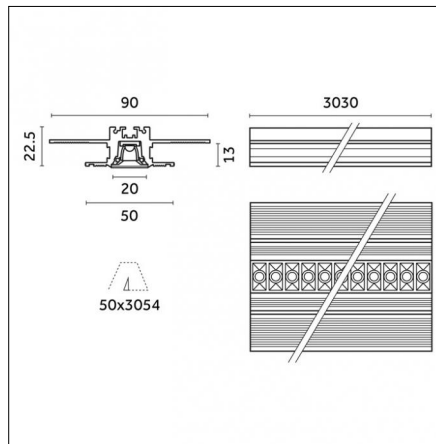
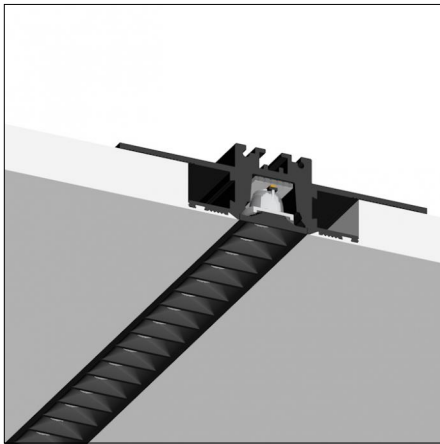

Very wide 40°

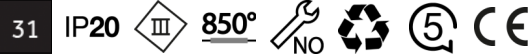

Code X.CN5UL.HW31

Light source features

Number of light sources: 1

Source type: LED HW

Watt: 63W

Lm: 8736lm

Lm/W: 143lm/W

Kelvin/CRI: 2700K / >90

SDCM/L80 B10: < 3 / 50000

Fixture total output: 5711 lm

Fixture efficacy: 79 lm/W

Electrical features

Driver included: NO

Driver position: remote

Driver type: no driver included 24V DC

Total power consumption (LED + DRIVER): 72W

Isolation class: Class III

Driver note: See wiring diagrams for configurations

Optical features

Beam angle: 40°

Interchangeable optic (IOS): NO

UGR : < 16

Physical features

Material: Extruded aluminum

Diffusing screen: Dark Performance

Mounting: Recessed

Finishing: Embossed matt black (Standard)

Notes:

End caps not included, to be ordered separately

Luminaire constructed in conformity with Directives 2014/35/EU (LV), 2014/30/EU (EMC), 2009/125/EC (Ecodesign) with Regulations (EC) No 245/2009, (EU) No 347/2010 and (EU) 2015/1428 (for luminaires with fluorescent and metal halide lamps only), 2009/125/EC (Ecodesign) with Regulations (EU) No 1194/2012 and 2015/1428 (for LED luminaires only), 2011/65/EU (RoHS 2) and 2012/19/EU (WEEE).

Reggiani SPA Illuminazione

Viale Monza, 16 20845 Sovico (MB) Italy
Tel. (+39) 039 2071.1 fax (+39) 039 2071 999

www.reggiani.net
contact@reggiani.net

Driver

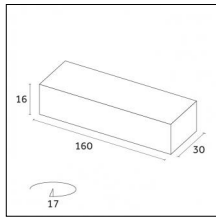

Code 0.30820.0000 - Driver

Type: On-Off
Watt: W - AC Input: 220-240Vac - mA:mA
Description:

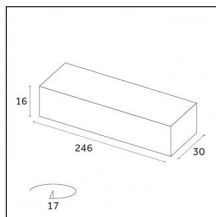

Code 0.30821.0000 - Driver

Type: On-Off
Watt: W - AC Input: 220-240Vac - mA:mA
Description:

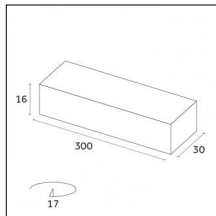

Code 0.30822.0000 - Driver

Type: On-Off
Watt: W - AC Input: 120-240V - mA:mA
Description:

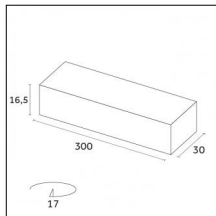

Code 0.30823.0000 - Driver

Type: On-Off
Watt: W - AC Input: 220-240Vac - mA:mA
Description:

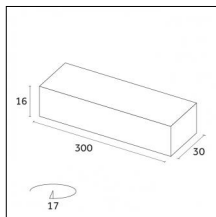

Code 0.30824.0000 - Driver

Type: On-Off
Watt: W - AC Input: 120-240V - mA:mA
Description:

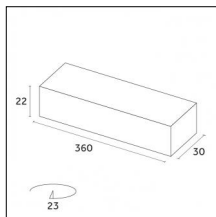

Code 0.30825.0000 - Driver

Type: On-Off
Watt: W - AC Input: 120-240V - mA:mA
Description:

Driver

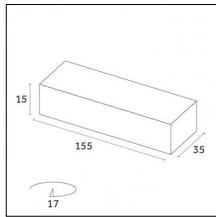

Code H.30826.0000 - Dimmer - 1 channel

Type: Bluetooth
Watt: W - AC Input: 24-48Vcc - mA:mA
Description:

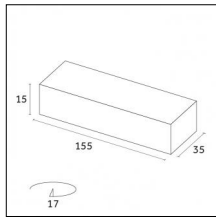

Code H.30827.0000 - Dimmer - 2 channels - for Tunable White

Type: Bluetooth
Watt: W - AC Input: 24-48Vcc - mA:mA
Description:

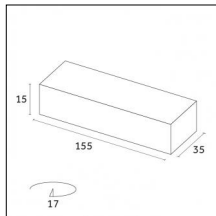

Code Y.30826.0000 - Dimmer -1 channel

Type: Dimmer 1-10V / DALI / PUSH
Watt: W - AC Input: 24-48Vcc - mA:mA
Description:

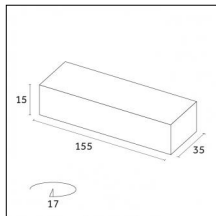

Code Y.30827.0000 - Dimmer - 2 channels - for Tunable White

Type: Dimmer 1-10V / DALI / PUSH
Watt: W - AC Input: 24-48Vcc - mA:mA
Description:

Accessories

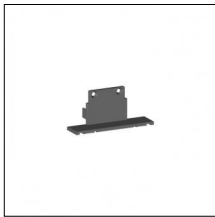
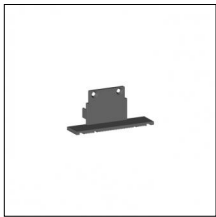

Code 0.26810.0001 - End caps (2x) Traceline Recessed Trimless

Type: Mounting
Finishing: Chrome

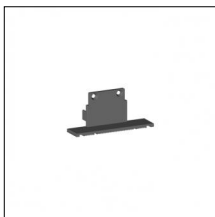
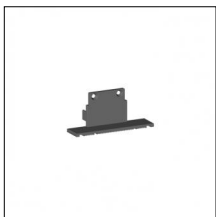

Code 0.26810.0012 - End caps (2x) Traceline Recessed Trimless

Type: Mounting
Finishing: Embossed matt white (Standard)

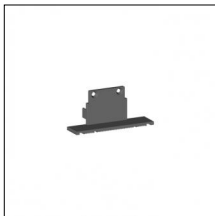
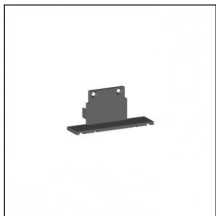

Code 0.26810.0031 - End caps (2x) Traceline Recessed Trimless

Type: Mounting
Finishing: Embossed matt black (Standard)

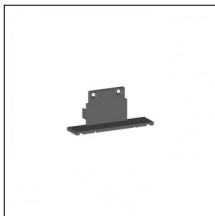
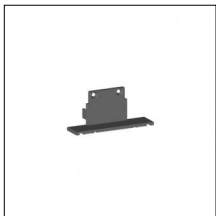

Code 0.26810.00B0 - End caps (2x) Traceline Recessed Trimless

Type: Mounting
Finishing: Royal matt black

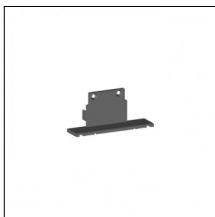
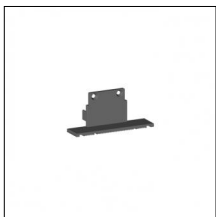

Code 0.26810.00C0 - End caps (2x) Traceline Recessed Trimless

Type: Mounting
Finishing: Royal matt white

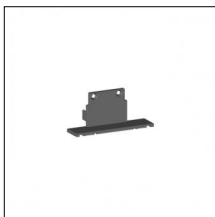
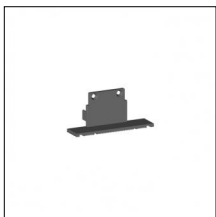

Code 0.26810.00D0 - End caps (2x) Traceline Recessed Trimless

Type: Mounting
Finishing: Brushed brass

Luminaire constructed in conformity with Directives 2014/35/EU (LV), 2014/30/EU (EMC), 2009/125/EC (Ecodesign) with Regulations (EC) No 245/2009, (EU) No 347/2010 and (EU) 2015/1428 (for luminaires with fluorescent and metal halide lamps only), 2009/125/EC (Ecodesign) with Regulations (EU) No 1194/2012 and 2015/1428 (for LED luminaires only), 2011/65/EU (RoHS 2) and 2012/19/EU (WEEE).

Accessories

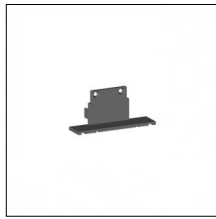
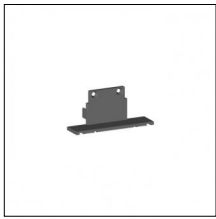

Code 0.26810.00E0 - End caps (2x) Traceline Recessed Trimless

Type: Mounting
Finishing: Brushed gold

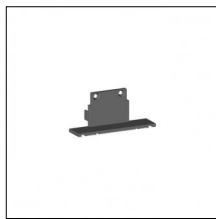
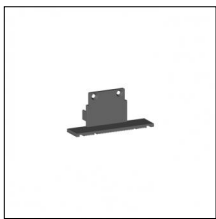

Code 0.26810.00L0 - End caps (2x) Traceline Recessed Trimless

Type: Mounting
Finishing: Antiqued brushed bronze

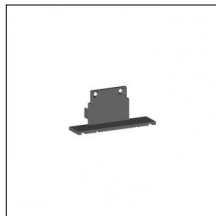
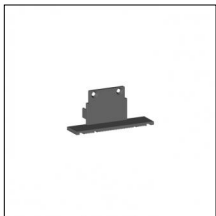

Code 0.26810.00M0 - End caps (2x) Traceline Recessed Trimless

Type: Mounting
Finishing: Brushed aluminum

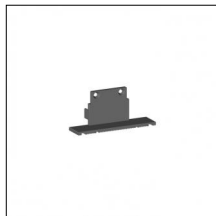
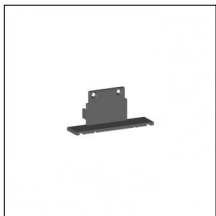

Code 0.26810.00N0 - End caps (2x) Traceline Recessed Trimless

Type: Mounting
Finishing: Brushed copper

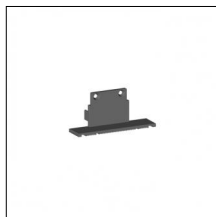
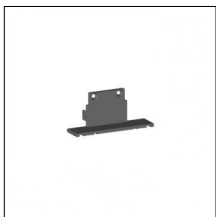

Code 0.26810.00T1 - End caps (2x) Traceline Recessed Trimless

Type: Mounting
Finishing: Anodized Bronze

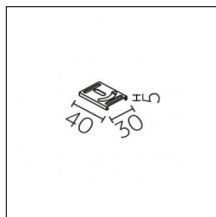

Code 0.26879.0000 - 3-way distributor - (1in - 2out)

Type: Electrical
Finishing: Without finish / Stainless Steel / Natural aluminium (Standard)
Description:

1in - 2out - 16A-250V

Polyamide body

Silver plated brass contacts

Luminaire constructed in conformity with Directives 2014/35/EU (LV), 2014/30/EU (EMC), 2009/125/EC (Ecodesign) with Regulations (EC) No 245/2009, (EU) No 347/2010 and (EU) 2015/1428 (for luminaires with fluorescent and metal halide lamps only), 2009/125/EC (Ecodesign) with Regulations (EU) No 1194/2012 and 2015/1428 (for LED luminaires only), 2011/65/EU (RoHS 2) and 2012/19/EU (WEEE).

Accessories

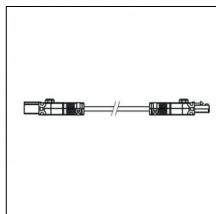

Code 0.26880.0000 - Plug to Socket with extension cable

Type: Electrical

Finishing: Without finish / Stainles Steel / Natural aluminium (Standard)

Description:

Extension cable multicore 1x2,5mm

16A-250V

Cable length 3000mm

Maximum capacity 84W/3m

Indoor | Recessed luminaires | Traceline Recessed

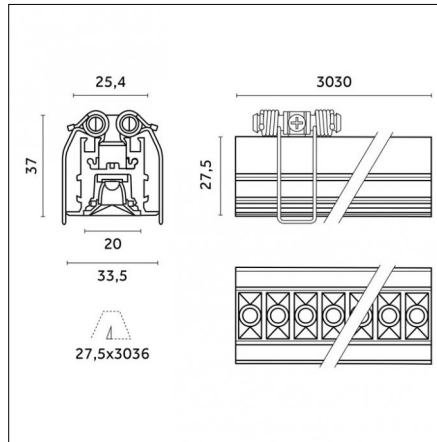
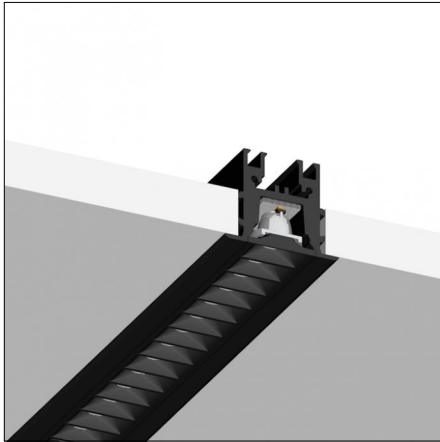

Very wide 40°

01

IP20



850°



Code X.CN3UL.HC01

Light source features

Number of light sources: 1

Source type: LED HC

Watt: 63W

Lm: 8736lm

Lm/W: 143lm/W

Kelvin/CRI: 3000K / >95

SDCM/L80 B10: < 3 / 50000

Fixture total output: 5720 lm

Fixture efficacy: 79 lm/W

Electrical features

Driver included: NO

Driver position: remote

Driver type: no driver included 24V DC

Total power consumption (LED + DRIVER): 72W

Isolation class: Class III

Driver note: See wiring diagrams for configurations

Optical features

Beam angle: 40°

Interchangeable optic (IOS): NO

UGR : < 16

Physical features

Material: Extruded aluminum

Diffusing screen: Dark Performance

Mounting: Recessed

Finishing: Chrome

Notes:

End caps not included, to be ordered separately

Luminaire constructed in conformity with Directives 2014/35/EU (LV), 2014/30/EU (EMC), 2009/125/EC (Ecodesign) with Regulations (EC) No 245/2009, (EU) No 347/2010 and (EU) 2015/1428 (for luminaires with fluorescent and metal halide lamps only), 2009/125/EC (Ecodesign) with Regulations (EU) No 1194/2012 and 2015/1428 (for LED luminaires only), 2011/65/EU (RoHS 2) and 2012/19/EU (WEEE).

Reggiani SPA Illuminazione

Viale Monza, 16 20845 Sovico (MB) Italy
Tel. (+39) 039 2071.1 fax (+39) 039 2071 999

www.reggiani.net
contact@reggiani.net

Driver

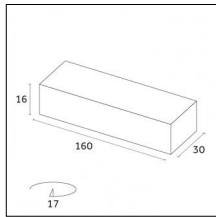

Code 0.30820.0000 - Driver

Type: On-Off
Watt: W - AC Input: 220-240Vac - mA:mA
Description:

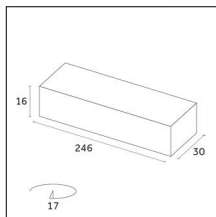

Code 0.30821.0000 - Driver

Type: On-Off
Watt: W - AC Input: 220-240Vac - mA:mA
Description:

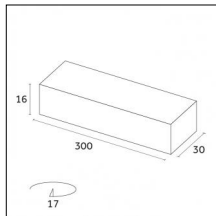

Code 0.30822.0000 - Driver

Type: On-Off
Watt: W - AC Input: 120-240V - mA:mA
Description:

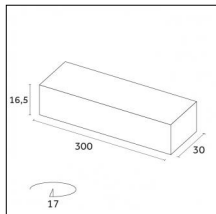

Code 0.30823.0000 - Driver

Type: On-Off
Watt: W - AC Input: 220-240Vac - mA:mA
Description:

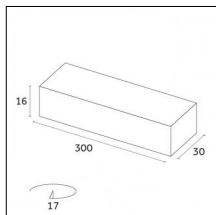

Code 0.30824.0000 - Driver

Type: On-Off
Watt: W - AC Input: 120-240V - mA:mA
Description:

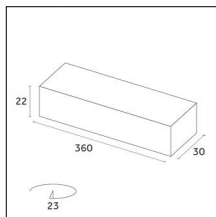

Code 0.30825.0000 - Driver

Type: On-Off
Watt: W - AC Input: 120-240V - mA:mA
Description:

Driver

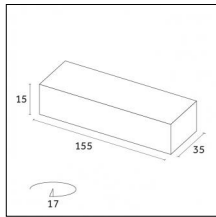

Code H.30826.0000 - Dimmer - 1 channel

Type: Bluetooth
Watt: W - AC Input: 24-48Vcc - mA:mA
Description:

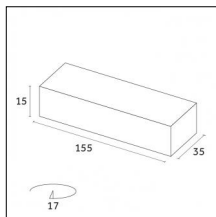

Code H.30827.0000 - Dimmer - 2 channels - for Tunable White

Type: Bluetooth
Watt: W - AC Input: 24-48Vcc - mA:mA
Description:

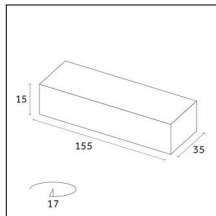

Code Y.30826.0000 - Dimmer -1 channel

Type: Dimmer 1-10V / DALI / PUSH
Watt: W - AC Input: 24-48Vcc - mA:mA
Description:

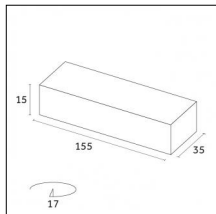

Code Y.30827.0000 - Dimmer - 2 channels - for Tunable White

Type: Dimmer 1-10V / DALI / PUSH
Watt: W - AC Input: 24-48Vcc - mA:mA
Description:

Accessories

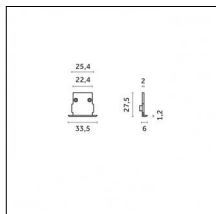
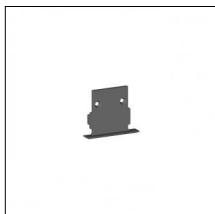

Code 0.26808.0001 - End caps (2x) Traceline Recessed Trim

Type: Mounting
Finishing: Chrome

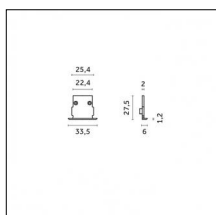
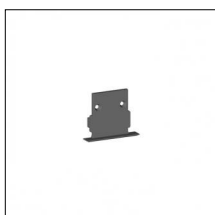

Code 0.26808.0012 - End caps (2x) Traceline Recessed Trim

Type: Mounting
Finishing: Embossed matt white (Standard)

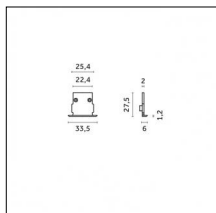
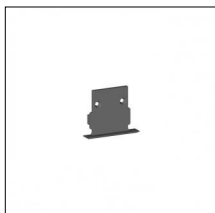

Code 0.26808.0031 - End caps (2x) Traceline Recessed Trim

Type: Mounting
Finishing: Embossed matt black (Standard)

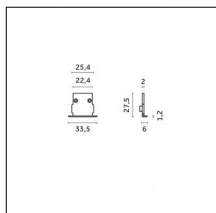
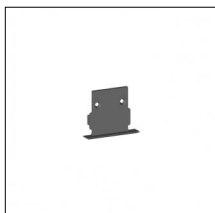

Code 0.26808.00B0 - End caps (2x) Traceline Recessed Trim

Type: Mounting
Finishing: Royal matt black

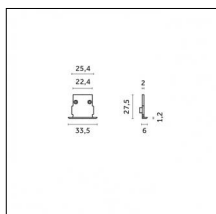
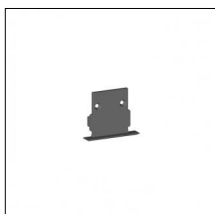

Code 0.26808.00C0 - End caps (2x) Traceline Recessed Trim

Type: Mounting
Finishing: Royal matt white

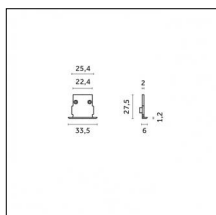
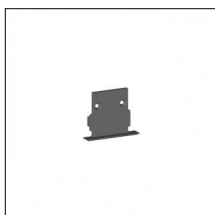

Code 0.26808.00D0 - End caps (2x) Traceline Recessed Trim

Type: Mounting
Finishing: Brushed brass

Luminaire constructed in conformity with Directives 2014/35/EU (LV), 2014/30/EU (EMC), 2009/125/EC (Ecodesign) with Regulations (EC) No 245/2009, (EU) No 347/2010 and (EU) 2015/1428 (for luminaires with fluorescent and metal halide lamps only), 2009/125/EC (Ecodesign) with Regulations (EU) No 1194/2012 and 2015/1428 (for LED luminaires only), 2011/65/EU (RoHS 2) and 2012/19/EU (WEEE).

Accessories

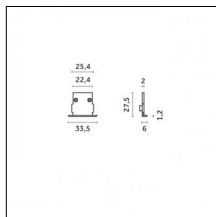
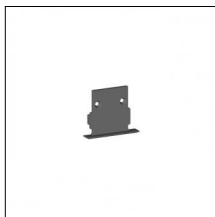

Code 0.26808.00E0 - End caps (2x) Traceline Recessed Trim

Type: Mounting
Finishing: Brushed gold

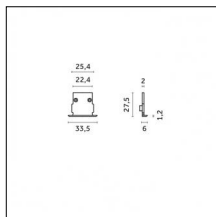
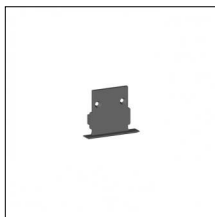

Code 0.26808.00L0 - End caps (2x) Traceline Recessed Trim

Type: Mounting
Finishing: Antiqued brushed bronze

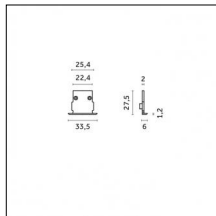
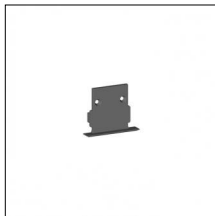

Code 0.26808.00M0 - End caps (2x) Traceline Recessed Trim

Type: Mounting
Finishing: Brushed aluminum

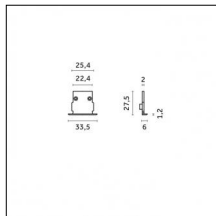
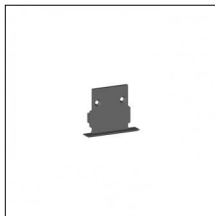

Code 0.26808.00N0 - End caps (2x) Traceline Recessed Trim

Type: Mounting
Finishing: Brushed copper

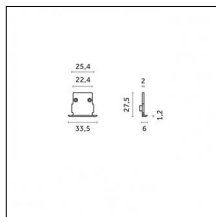
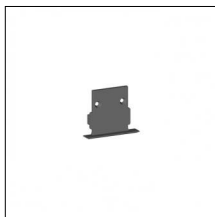

Code 0.26808.00T1 - End caps (2x) Traceline Recessed Trim

Type: Mounting
Finishing: Anodized Bronze

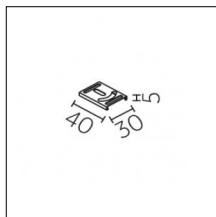

Code 0.26879.0000 - 3-way distributor - (1in - 2out)

Type: Electrical
Finishing: Without finish / Stainles Steel / Natural aluminium (Standard)
Description:

1in - 2out - 16A-250V

Polyamide body

Silver plated brass contacts

Luminaire constructed in conformity with Directives 2014/35/EU (LV), 2014/30/EU (EMC), 2009/125/EC (Ecodesign) with Regulations (EC) No 245/2009, (EU) No 347/2010 and (EU) 2015/1428 (for luminaires with fluorescent and metal halide lamps only), 2009/125/EC (Ecodesign) with Regulations (EU) No 1194/2012 and 2015/1428 (for LED luminaires only), 2011/65/EU (RoHS 2) and 2012/19/EU (WEEE).

Accessories

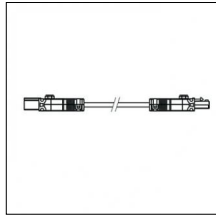

Code 0.26880.0000 - Plug to Socket with extension cable

Type: Electrical

Finishing: Without finish / Stainles Steel / Natural aluminium (Standard)

Description:

Extension cable multicore 1x2,5mm

16A-250V

Cable length 3000mm

Maximum capacity 84W/3m