

# DRX5; Recessed - Standard LED 4° Optic 14W

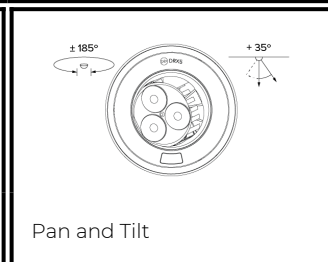
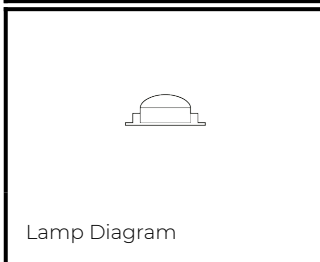
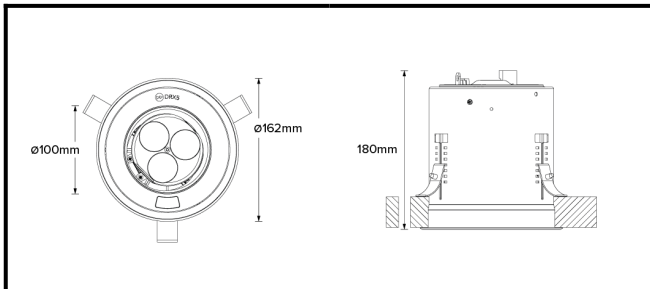

<b>PHYSICAL</b>	<b>CONSTRUCTION MATERIALS:</b>	LM24 Aluminium, Glass-filled Polycarbonate, Mild Steel mounting ring
	<b>MOUNTING:</b>	Recessed - Standard
	<b>WEIGHT:</b>	1.55kg
	<b>FINISH:</b>	White RAL9010
	<b>MAX AMBIENT TEMPERATURE:</b>	40°C
	<b>CEILING CLEARANCE:</b>	200mm
	<b>CEILING CUT-OUT:</b>	145mm
	<b>CEILING THICKNESS:</b>	10-55mm

<b>CONTROL</b>	<b>MOVEMENT TYPE:</b>	Handheld Remote
	<b>DIMMING OPTION:</b>	Handheld Remote

**SPECIFICATION** DRX5 3000K LED (10W for light source) standard trim recessed luminaire with 4-° optic. Manufactured from LM24 aluminium and glass-filled polycarbonate, with a mild-steel mounting ring. Finished in white (RAL 9010). Voltage is 100-277V 50/60HZ. Luminaire has high-performance colour rendering of 80+ CRI. Luminaire can be rotated, with +/- 185-° movement through the pan axis and +35 through the tilt axis, at a resolution of less than 1-° in either axis. Movement and dimming is controlled using a handheld remote. Recording and recalling of scenes as standard.

PART NO.

**DRX5.0001**
**PRODUCT SUMMARY**

DRX5 Spotlight; 100-277V 50/60Hz; Standard Trim Mounting; 4-° Optic; 3000K 80+CRI LED 10W; White; Movement &amp; Dimming using Handheld Remote

# DRX5; Recessed - Standard LED 4° Optic 14W

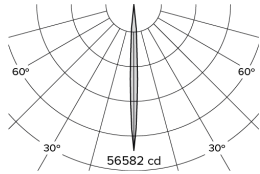

Photometry

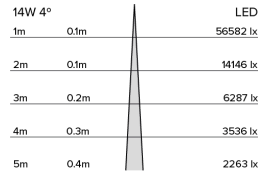

Cone Diagram

<b>MOVEMENT</b>	<b>MOVEMENT TYPE:</b>	Handheld Remote
	<b>PAN MOVEMENT RANGE:</b>	±185°
	<b>TILT MOVEMENT RANGE:</b>	+35°
	<b>PAN MOVEMENT RESOLUTION:</b>	<1°
	<b>TILT MOVEMENT RESOLUTION:</b>	<1°
	<b>PAN SPEED OF MOVEMENT:</b>	20°/s
	<b>TILT SPEED OF MOVEMENT:</b>	20°/s

<b>LIGHTING</b>	<b>LIGHT SOURCE:</b>	LED
	<b>MIN. DISTANCE FROM TARGET:</b>	N/A
	<b>MODULE LUMEN OUTPUT:</b>	594lm
	<b>ABSOLUTE LUMEN OUTPUT:</b>	540lm
	<b>GLARE MECHANICAL CUT-OFF:</b>	26°
	<b>GLARE COMFORT CUT-OFF:</b>	52°
	<b>COLOUR TEMP:</b>	3000K

<b>ELECTRICAL</b>	<b>VOLTAGE REGION:</b>	100 - 277V 50/60Hz
	<b>IEC PROTECTION CLASS:</b>	Class 2
	<b>LIGHT SOURCE WATTAGE:</b>	10W
	<b>MOVEMENT WATTAGE:</b>	3W
	<b>LUMINAIRE CIRCUIT WATTAGE:</b>	14W

PART NO. **DRX5.0001**

**PRODUCT SUMMARY**

DRX5 Spotlight; 100-277V 50/60Hz; Standard Trim Mounting; 4-Optic; 3000K 80+CRI LED 10W; White; Movement & Dimming using Handheld Remote

# DRX5; Recessed - Standard LED 4° Optic 14W

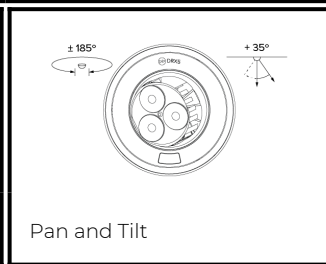
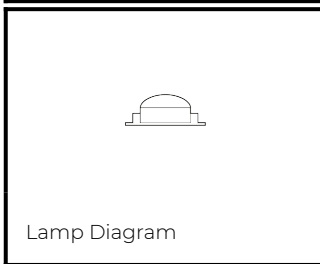
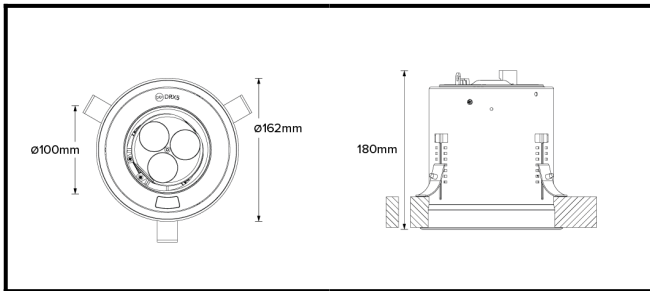

<b>PHYSICAL</b>	<b>CONSTRUCTION MATERIALS:</b>	LM24 Aluminium, Glass-filled Polycarbonate, Mild Steel mounting ring
	<b>MOUNTING:</b>	Recessed - Standard
	<b>WEIGHT:</b>	1.55kg
	<b>FINISH:</b>	White RAL9010
	<b>MAX AMBIENT TEMPERATURE:</b>	40°C
	<b>CEILING CLEARANCE:</b>	200mm
	<b>CEILING CUT-OUT:</b>	145mm
	<b>CEILING THICKNESS:</b>	10-55mm

<b>CONTROL</b>	<b>MOVEMENT TYPE:</b>	Handheld Remote
	<b>DIMMING OPTION:</b>	DMX

**SPECIFICATION** DRX5 3000K LED (10W for light source) standard trim recessed luminaire with 4-° optic. Manufactured from LM24 aluminium and glass-filled polycarbonate, with a mild-steel mounting ring. Finished in white (RAL 9010). Voltage is 100-277V 50/60HZ. Luminaire has high-performance colour rendering of 80+ CRI. Luminaire can be rotated, with +/- 185- movement through the pan axis and +35 through the tilt axis, at a resolution of less than 1- in either axis. Movement is controlled using a handheld remote, and dimming is controlled using DMX Recording and recalling of scenes as standard.

PART NO.

**DRX5.0002**
**PRODUCT SUMMARY**

DRX5 Spotlight; 100-277V 50/60Hz; Standard Trim Mounting; 4-° Optic; 3000K 80+CRI LED 10W; White; Movement using Handheld Remote; Dimming using DMX Control

# DRX5; Recessed - Standard LED 4° Optic 14W

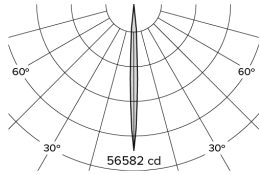

Photometry

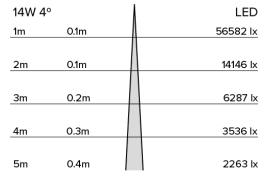

Cone Diagram

<b>MOVEMENT</b>	<b>MOVEMENT TYPE:</b>	Handheld Remote
	<b>PAN MOVEMENT RANGE:</b>	±185°
	<b>TILT MOVEMENT RANGE:</b>	+35°
	<b>PAN MOVEMENT RESOLUTION:</b>	<1°
	<b>TILT MOVEMENT RESOLUTION:</b>	<1°
	<b>PAN SPEED OF MOVEMENT:</b>	20°/s
	<b>TILT SPEED OF MOVEMENT:</b>	20°/s

<b>LIGHTING</b>	<b>LIGHT SOURCE:</b>	LED
	<b>MIN. DISTANCE FROM TARGET:</b>	N/A
	<b>MODULE LUMEN OUTPUT:</b>	594lm
	<b>ABSOLUTE LUMEN OUTPUT:</b>	540lm
	<b>GLARE MECHANICAL CUT-OFF:</b>	26°
	<b>GLARE COMFORT CUT-OFF:</b>	52°
	<b>COLOUR TEMP:</b>	3000K

<b>ELECTRICAL</b>	<b>VOLTAGE REGION:</b>	100 - 277V 50/60Hz
	<b>IEC PROTECTION CLASS:</b>	Class 2
	<b>LIGHT SOURCE WATTAGE:</b>	10W
	<b>MOVEMENT WATTAGE:</b>	3W
	<b>LUMINAIRE CIRCUIT WATTAGE:</b>	14W

PART NO.

**DRX5.0002**

**PRODUCT SUMMARY**

DRX5 Spotlight; 100-277V 50/60Hz; Standard Trim Mounting; 4-Ø Optic; 3000K 80+CRI LED 10W; White; Movement using Handheld Remote; Dimming using DMX Control

# DRX5; Recessed - Standard LED 4° Optic 14W

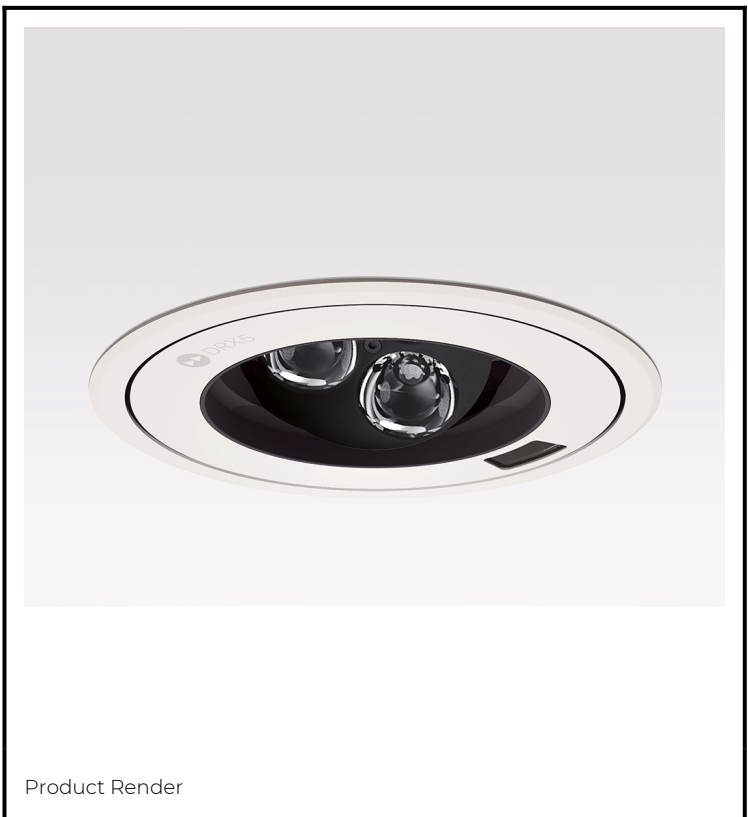
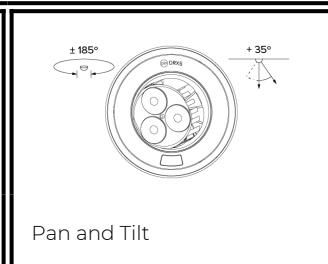
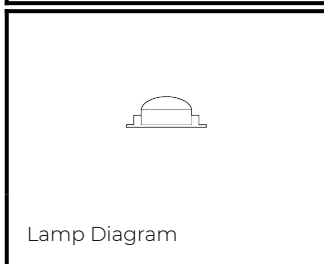
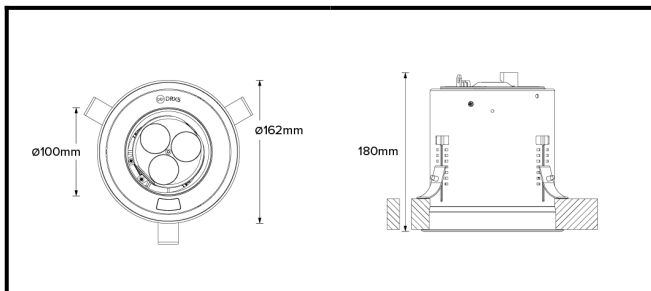

PHYSICAL	<b>CONSTRUCTION MATERIALS:</b>	LM24 Aluminium, Glass-filled Polycarbonate, Mild Steel mounting ring
	<b>MOUNTING:</b>	Recessed - Standard
	<b>WEIGHT:</b>	1.55kg
	<b>FINISH:</b>	White RAL9010
	<b>MAX AMBIENT TEMPERATURE:</b>	40°C
	<b>CEILING CLEARANCE:</b>	200mm
	<b>CEILING CUT-OUT:</b>	145mm
	<b>CEILING THICKNESS:</b>	10-55mm

CONTROL	<b>MOVEMENT TYPE:</b>	DMX
	<b>DIMMING OPTION:</b>	DMX

**SPECIFICATION** DRX5 3000K LED (10W for light source) standard trim recessed luminaire with 4-° optic. Manufactured from LM24 aluminium and glass-filled polycarbonate, with a mild-steel mounting ring. Finished in white (RAL 9010). Voltage is 100-277V 50/60HZ. Luminaire has high-performance colour rendering of 80+ CRI. Luminaire can be rotated, with +/- 185-° movement through the pan axis and +35 through the tilt axis, at a resolution of less than 1-° in either axis. Movement and dimming is controlled by DMX. Recording and recalling of scenes as standard.

PART NO.

**DRX5.0003**

**PRODUCT SUMMARY**

DRX5 Spotlight; 100-277V 50/60Hz; Standard Trim Mounting; 4-° Optic; 3000K 80+CRI LED 10W; White; Movement & Dimming using DMX Control only

# DRX5; Recessed - Standard LED 4° Optic 14W

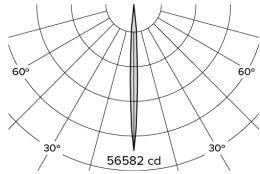

Photometry

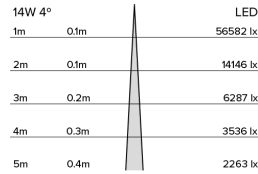

Cone Diagram

<b>MOVEMENT</b>	<b>MOVEMENT TYPE:</b>	DMX
	<b>PAN MOVEMENT RANGE:</b>	±185°
	<b>TILT MOVEMENT RANGE:</b>	+35°
	<b>PAN MOVEMENT RESOLUTION:</b>	<1°
	<b>TILT MOVEMENT RESOLUTION:</b>	<1°
	<b>PAN SPEED OF MOVEMENT:</b>	20°/s
	<b>TILT SPEED OF MOVEMENT:</b>	20°/s

<b>LIGHTING</b>	<b>LIGHT SOURCE:</b>	LED
	<b>MIN. DISTANCE FROM TARGET:</b>	N/A
	<b>MODULE LUMEN OUTPUT:</b>	594lm
	<b>ABSOLUTE LUMEN OUTPUT:</b>	540lm
	<b>GLARE MECHANICAL CUT-OFF:</b>	26°
	<b>GLARE COMFORT CUT-OFF:</b>	52°
<b>COLOUR TEMP:</b>	3000K	

<b>ELECTRICAL</b>	<b>VOLTAGE REGION:</b>	100 - 277V 50/60Hz
	<b>IEC PROTECTION CLASS:</b>	Class 2
	<b>LIGHT SOURCE WATTAGE:</b>	10W
	<b>MOVEMENT WATTAGE:</b>	3W
	<b>LUMINAIRE CIRCUIT WATTAGE:</b>	14W

PART NO. **DRX5.0003**

**PRODUCT SUMMARY** DRX5 Spotlight; 100-277V 50/60Hz; Standard Trim Mounting; 4-Optic; 3000K 80+CRI LED 10W; White; Movement & Dimming using DMX Control only

# DRX5; Recessed - Standard LED 4° Optic 14W

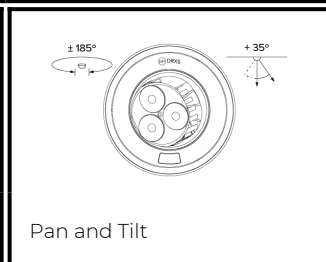
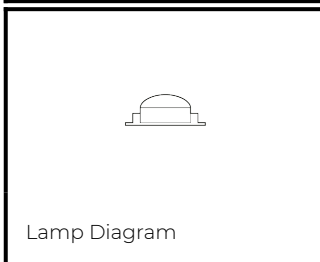
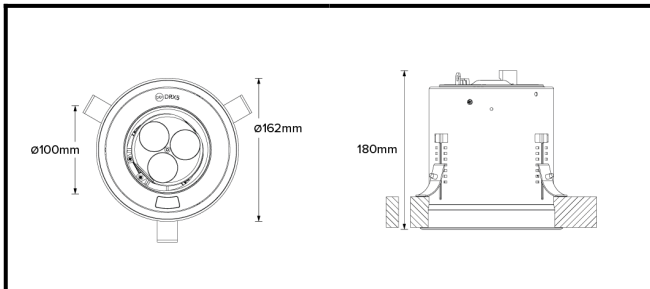

<b>PHYSICAL</b>	<b>CONSTRUCTION MATERIALS:</b>	LM24 Aluminium, Glass-filled Polycarbonate, Mild Steel mounting ring
	<b>MOUNTING:</b>	Recessed - Standard
	<b>WEIGHT:</b>	1.55kg
	<b>FINISH:</b>	White RAL9010
	<b>MAX AMBIENT TEMPERATURE:</b>	40°C
	<b>CEILING CLEARANCE:</b>	200mm
	<b>CEILING CUT-OUT:</b>	145mm
	<b>CEILING THICKNESS:</b>	10-55mm

<b>CONTROL</b>	<b>MOVEMENT TYPE:</b>	Handheld Remote
	<b>DIMMING OPTION:</b>	DALI Dimming

**SPECIFICATION** DRX5 3000K LED (10W for light source) standard trim recessed luminaire with 4-° optic. Manufactured from LM24 aluminium and glass-filled polycarbonate, with a mild-steel mounting ring. Finished in white (RAL 9010). Voltage is 100-277V 50/60HZ. Luminaire has high-performance colour rendering of 80+ CRI. Luminaire can be rotated, with +/- 185- movement through the pan axis and +35 through the tilt axis, at a resolution of less than 1- in either axis. Movement is controlled using a handheld remote, and dimming is controlled using external DALI dimming. Recording and recalling of scenes as standard.

PART NO.

**DRX5.0004**
**PRODUCT SUMMARY**

DRX5 Spotlight; 100-277V 50/60Hz; Standard Trim Mounting; 4-° Optic; 3000K 80+CRI LED 10W; White; Movement using Handheld Remote; Dimming Using External DALI Control

# DRX5; Recessed - Standard LED 4° Optic 14W

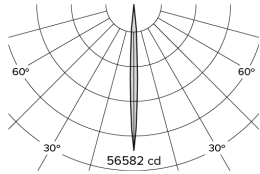

Photometry

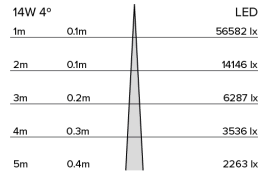

Cone Diagram

<b>MOVEMENT</b>	<b>MOVEMENT TYPE:</b>	Handheld Remote
	<b>PAN MOVEMENT RANGE:</b>	±185°
	<b>TILT MOVEMENT RANGE:</b>	+35°
	<b>PAN MOVEMENT RESOLUTION:</b>	<1°
	<b>TILT MOVEMENT RESOLUTION:</b>	<1°
	<b>PAN SPEED OF MOVEMENT:</b>	20°/s
	<b>TILT SPEED OF MOVEMENT:</b>	20°/s

<b>LIGHTING</b>	<b>LIGHT SOURCE:</b>	LED
	<b>MIN. DISTANCE FROM TARGET:</b>	N/A
	<b>MODULE LUMEN OUTPUT:</b>	594lm
	<b>ABSOLUTE LUMEN OUTPUT:</b>	540lm
	<b>GLARE MECHANICAL CUT-OFF:</b>	26°
	<b>GLARE COMFORT CUT-OFF:</b>	52°
<b>COLOUR TEMP:</b>	3000K	

<b>ELECTRICAL</b>	<b>VOLTAGE REGION:</b>	100 - 277V 50/60Hz
	<b>IEC PROTECTION CLASS:</b>	Class 2
	<b>LIGHT SOURCE WATTAGE:</b>	10W
	<b>MOVEMENT WATTAGE:</b>	3W
	<b>LUMINAIRE CIRCUIT WATTAGE:</b>	14W

PART NO. **DRX5.0004**

**PRODUCT SUMMARY** DRX5 Spotlight; 100-277V 50/60Hz; Standard Trim Mounting; 4-Ø Optic; 3000K 80+CRI LED 10W; White; Movement using Handheld Remote; Dimming Using External DALI Control



# DRX5; Recessed - Standard LED 4° Optic 14W

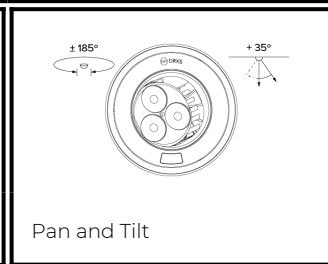
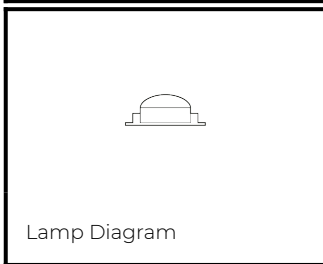
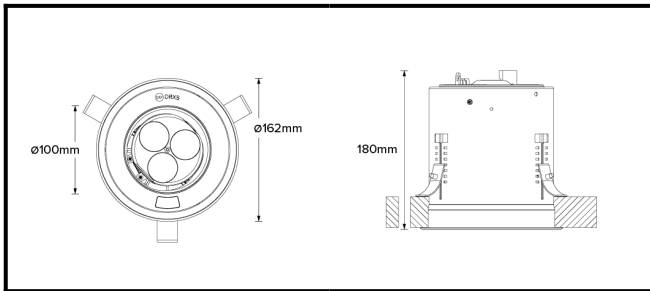

<b>PHYSICAL</b>	<b>CONSTRUCTION MATERIALS:</b>	LM24 Aluminium, Glass-filled Polycarbonate, Mild Steel mounting ring
	<b>MOUNTING:</b>	Recessed - Standard
	<b>WEIGHT:</b>	1.55kg
	<b>FINISH:</b>	White RAL9010
	<b>MAX AMBIENT TEMPERATURE:</b>	40°C
	<b>CEILING CLEARANCE:</b>	200mm
	<b>CEILING CUT-OUT:</b>	145mm
	<b>CEILING THICKNESS:</b>	10-55mm

<b>CONTROL</b>	<b>MOVEMENT TYPE:</b>	Handheld Remote
	<b>DIMMING OPTION:</b>	1-10V

**SPECIFICATION** DRX5 3000K LED (10W for light source) standard trim recessed luminaire with 4-° optic. Manufactured from LM24 aluminium and glass-filled polycarbonate, with a mild-steel mounting ring. Finished in white (RAL 9010). Voltage is 100-277V 50/60HZ. Luminaire has high-performance colour rendering of 80+ CRI. Luminaire can be rotated, with +/- 185- movement through the pan axis and +35 through the tilt axis, at a resolution of less than 1- in either axis. Movement is controlled using a handheld remote, and dimming is controlled using external 1-10V dimming. Recording and recalling of scenes as standard.

PART NO.

**DRX5.0005**
**PRODUCT SUMMARY**

DRX5 Spotlight; 100-277V 50/60Hz; Standard Trim Mounting; 4-° Optic; 3000K 80+CRI LED 10W; White; Movement using Handheld Remote; Dimming Using External (1-10V)

# DRX5; Recessed - Standard LED 4° Optic 14W

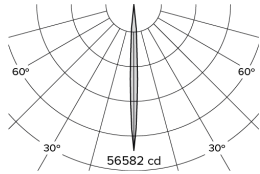

Photometry

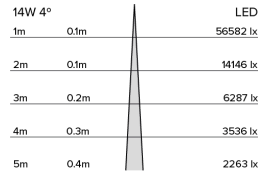

Cone Diagram

<b>MOVEMENT</b>	<b>MOVEMENT TYPE:</b>	Handheld Remote
	<b>PAN MOVEMENT RANGE:</b>	±185°
	<b>TILT MOVEMENT RANGE:</b>	+35°
	<b>PAN MOVEMENT RESOLUTION:</b>	<1°
	<b>TILT MOVEMENT RESOLUTION:</b>	<1°
	<b>PAN SPEED OF MOVEMENT:</b>	20°/s
	<b>TILT SPEED OF MOVEMENT:</b>	20°/s

<b>LIGHTING</b>	<b>LIGHT SOURCE:</b>	LED
	<b>MIN. DISTANCE FROM TARGET:</b>	N/A
	<b>MODULE LUMEN OUTPUT:</b>	594lm
	<b>ABSOLUTE LUMEN OUTPUT:</b>	540lm
	<b>GLARE MECHANICAL CUT-OFF:</b>	26°
	<b>GLARE COMFORT CUT-OFF:</b>	52°
<b>COLOUR TEMP:</b>	3000K	

<b>ELECTRICAL</b>	<b>VOLTAGE REGION:</b>	100 - 277V 50/60Hz
	<b>IEC PROTECTION CLASS:</b>	Class 2
	<b>LIGHT SOURCE WATTAGE:</b>	10W
	<b>MOVEMENT WATTAGE:</b>	3W
	<b>LUMINAIRE CIRCUIT WATTAGE:</b>	14W

PART NO. **DRX5.0005**

**PRODUCT SUMMARY**

DRX5 Spotlight; 100-277V 50/60Hz; Standard Trim Mounting; 4-Ø Optic; 3000K 80+CRI LED 10W; White; Movement using Handheld Remote; Dimming Using External (1-10V)

# DRX5; Recessed - Standard LED 4° Optic 14W

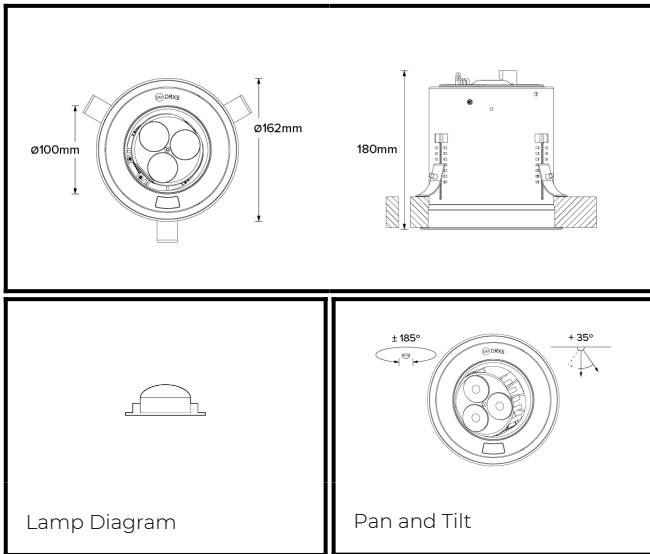

PHYSICAL	<b>CONSTRUCTION MATERIALS:</b>	LM24 Aluminium, Glass-filled Polycarbonate, Mild Steel mounting ring
	<b>MOUNTING:</b>	Recessed - Standard
	<b>WEIGHT:</b>	1.55kg
	<b>FINISH:</b>	Black RAL9005
	<b>MAX AMBIENT TEMPERATURE:</b>	40°C
	<b>CEILING CLEARANCE:</b>	200mm
	<b>CEILING CUT-OUT:</b>	145mm
	<b>CEILING THICKNESS:</b>	10-55mm

CONTROL	<b>MOVEMENT TYPE:</b>	Handheld Remote
	<b>DIMMING OPTION:</b>	Handheld Control

SPECIFICATION

DRX5 3000K LED (10W for light source) standard trim recessed luminaire with 4-° optic. Manufactured from LM24 aluminium and glass-filled polycarbonate, with a mild-steel mounting ring. Finished in black (RAL 9005). Voltage is 100-277V 50/60HZ. Luminaire has high-performance colour rendering of 80+ CRI. Luminaire can be rotated, with +/- 185-° movement through the pan axis and +35 through the tilt axis, at a resolution of less than 1-° in either axis. Movement and dimming is controlled using a handheld remote. Recording and recalling of scenes as standard.

PART NO.

**DRX5.0006**

**PRODUCT SUMMARY**

DRX5 Spotlight; 100-277V 50/60Hz; Standard Trim Mounting; 4-° Optic; 3000K 80+CRI LED 10W; Black; Movement & Dimming using Handheld Remote

# DRX5; Recessed - Standard LED 4° Optic 14W

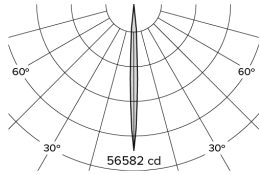

Photometry

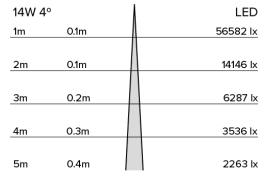

Cone Diagram

<b>MOVEMENT</b>	<b>MOVEMENT TYPE:</b>	Handheld Remote
	<b>PAN MOVEMENT RANGE:</b>	±185°
	<b>TILT MOVEMENT RANGE:</b>	+35°
	<b>PAN MOVEMENT RESOLUTION:</b>	<1°
	<b>TILT MOVEMENT RESOLUTION:</b>	<1°
	<b>PAN SPEED OF MOVEMENT:</b>	20°/s
	<b>TILT SPEED OF MOVEMENT:</b>	20°/s

<b>LIGHTING</b>	<b>LIGHT SOURCE:</b>	LED
	<b>MIN. DISTANCE FROM TARGET:</b>	N/A
	<b>MODULE LUMEN OUTPUT:</b>	594lm
	<b>ABSOLUTE LUMEN OUTPUT:</b>	540lm
	<b>GLARE MECHANICAL CUT-OFF:</b>	26°
	<b>GLARE COMFORT CUT-OFF:</b>	52°
<b>COLOUR TEMP:</b>	3000K	

<b>ELECTRICAL</b>	<b>VOLTAGE REGION:</b>	100 - 277V 50/60Hz
	<b>IEC PROTECTION CLASS:</b>	Class 2
	<b>LIGHT SOURCE WATTAGE:</b>	10W
	<b>MOVEMENT WATTAGE:</b>	3W
	<b>LUMINAIRE CIRCUIT WATTAGE:</b>	14W

PART NO. **DRX5.0006**

**PRODUCT SUMMARY**

DRX5 Spotlight; 100-277V 50/60Hz; Standard Trim Mounting; 4-Ø Optic; 3000K 80+CRI LED 10W; Black; Movement & Dimming using Handheld Remote

# DRX5; Recessed - Standard LED 4° Optic 14W

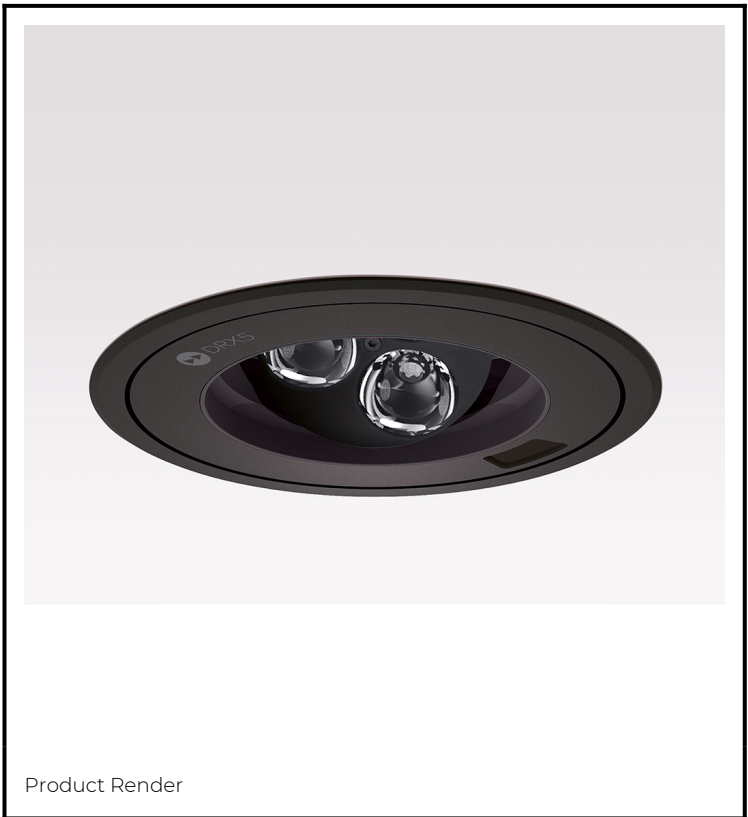
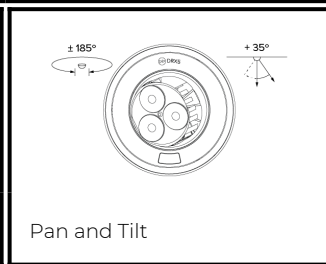
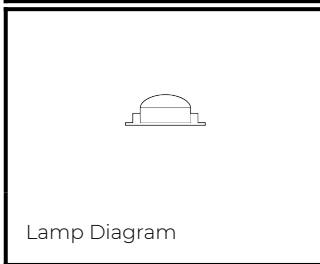
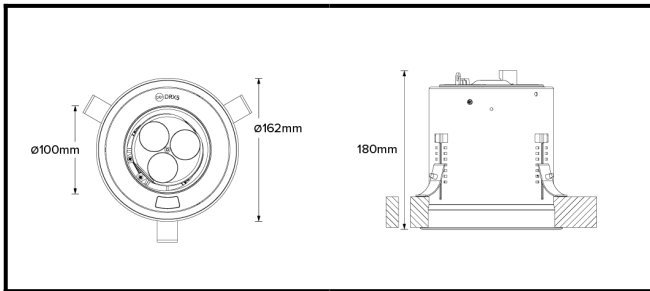

<b>PHYSICAL</b>	<b>CONSTRUCTION MATERIALS:</b>	LM24 Aluminium, Glass-filled Polycarbonate, Mild Steel mounting ring
	<b>MOUNTING:</b>	Recessed - Standard
	<b>WEIGHT:</b>	1.55kg
	<b>FINISH:</b>	Black RAL9005
	<b>MAX AMBIENT TEMPERATURE:</b>	40°C
	<b>CEILING CLEARANCE:</b>	200mm
	<b>CEILING CUT-OUT:</b>	145mm
	<b>CEILING THICKNESS:</b>	10-55mm

<b>CONTROL</b>	<b>MOVEMENT TYPE:</b>	Handheld Remote
	<b>DIMMING OPTION:</b>	DMX

**SPECIFICATION** DRX5 3000K LED (10W for light source) standard trim recessed luminaire with 4-° optic. Manufactured from LM24 aluminium and glass-filled polycarbonate, with a mild-steel mounting ring. Finished in black (RAL 9005). Voltage is 100-277V 50/60HZ. Luminaire has high-performance colour rendering of 80+ CRI. Luminaire can be rotated, with +/- 185- movement through the pan axis and +35 through the tilt axis, at a resolution of less than 1- in either axis. Movement is controlled using a handheld remote, and dimming is controlled using DMX Recording and recalling of scenes as standard.

PART NO.

**DRX5.0007**
**PRODUCT SUMMARY**

DRX5 Spotlight; 100-277V 50/60Hz; Standard Trim Mounting; 4-° Optic; 3000K 80+CRI LED 10W; Black; Movement using Handheld Remote; Dimming using DMX Control

# DRX5; Recessed - Standard LED 4° Optic 14W

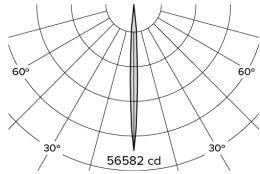

Photometry

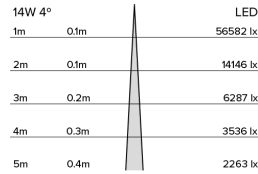

Cone Diagram

<b>MOVEMENT</b>	<b>MOVEMENT TYPE:</b>	Handheld Remote
	<b>PAN MOVEMENT RANGE:</b>	±185°
	<b>TILT MOVEMENT RANGE:</b>	+35°
	<b>PAN MOVEMENT RESOLUTION:</b>	<1°
	<b>TILT MOVEMENT RESOLUTION:</b>	<1°
	<b>PAN SPEED OF MOVEMENT:</b>	20°/s
	<b>TILT SPEED OF MOVEMENT:</b>	20°/s

<b>LIGHTING</b>	<b>LIGHT SOURCE:</b>	LED
	<b>MIN. DISTANCE FROM TARGET:</b>	N/A
	<b>MODULE LUMEN OUTPUT:</b>	594lm
	<b>ABSOLUTE LUMEN OUTPUT:</b>	540lm
	<b>GLARE MECHANICAL CUT-OFF:</b>	26°
	<b>GLARE COMFORT CUT-OFF:</b>	52°
<b>COLOUR TEMP:</b>	3000K	

<b>ELECTRICAL</b>	<b>VOLTAGE REGION:</b>	100 - 277V 50/60Hz
	<b>IEC PROTECTION CLASS:</b>	Class 2
	<b>LIGHT SOURCE WATTAGE:</b>	10W
	<b>MOVEMENT WATTAGE:</b>	3W
	<b>LUMINAIRE CIRCUIT WATTAGE:</b>	14W

PART NO. **DRX5.0007**

**PRODUCT SUMMARY**

DRX5 Spotlight; 100-277V 50/60Hz; Standard Trim Mounting; 4-Ø Optic; 3000K 80+CRI LED 10W; Black; Movement using Handheld Remote; Dimming using DMX Control

# DRX5; Recessed - Standard LED 4° Optic 14W

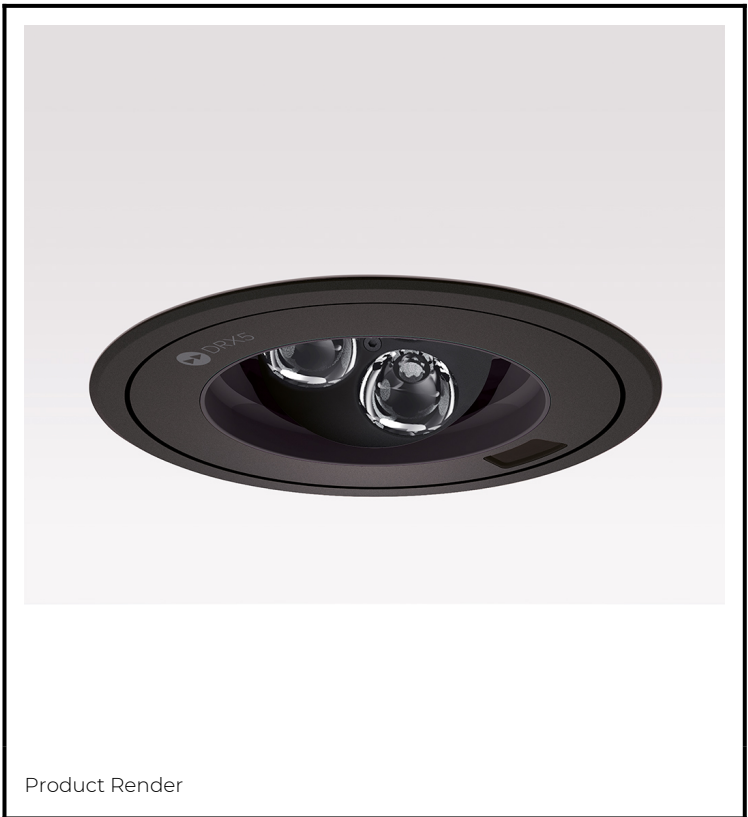
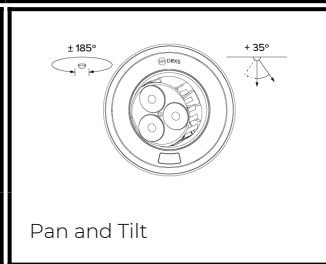
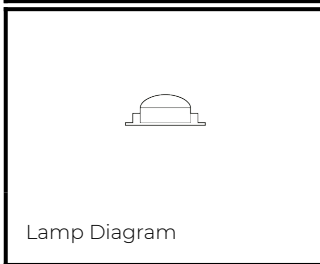
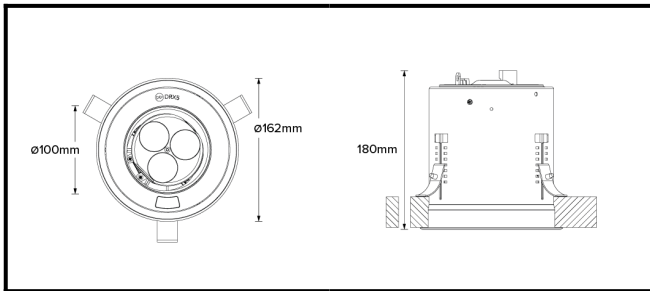

PHYSICAL	<b>CONSTRUCTION MATERIALS:</b>	LM24 Aluminium, Glass-filled Polycarbonate, Mild Steel mounting ring
	<b>MOUNTING:</b>	Recessed - Standard
	<b>WEIGHT:</b>	1.55kg
	<b>FINISH:</b>	Black RAL9005
	<b>MAX AMBIENT TEMPERATURE:</b>	40°C
	<b>CEILING CLEARANCE:</b>	200mm
	<b>CEILING CUT-OUT:</b>	145mm
	<b>CEILING THICKNESS:</b>	10-55mm

CONTROL	<b>MOVEMENT TYPE:</b>	DMX
	<b>DIMMING OPTION:</b>	DMX

**SPECIFICATION** DRX5 3000K LED (10W for light source) standard trim recessed luminaire with 4-° optic. Manufactured from LM24 aluminium and glass-filled polycarbonate, with a mild-steel mounting ring. Finished in black (RAL 9005). Voltage is 100-277V 50/60HZ. Luminaire has high-performance colour rendering of 80+ CRI. Luminaire can be rotated, with +/- 185-° movement through the pan axis and +35 through the tilt axis, at a resolution of less than 1-° in either axis. Movement and dimming is controlled by DMX. Recording and recalling of scenes as standard.

PART NO.

**DRX5.0008**
**PRODUCT SUMMARY**

DRX5 Spotlight; 100-277V 50/60Hz; Standard Trim Mounting; 4-° Optic; 3000K 80+CRI LED 10W; Black; Movement &amp; Dimming using DMX Control only

# DRX5; Recessed - Standard LED 4° Optic 14W

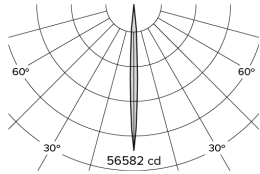

Photometry

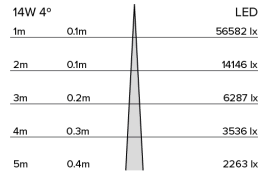

Cone Diagram

<b>MOVEMENT</b>	<b>MOVEMENT TYPE:</b>	DMX
	<b>PAN MOVEMENT RANGE:</b>	±185°
	<b>TILT MOVEMENT RANGE:</b>	+35°
	<b>PAN MOVEMENT RESOLUTION:</b>	<1°
	<b>TILT MOVEMENT RESOLUTION:</b>	<1°
	<b>PAN SPEED OF MOVEMENT:</b>	20°/s
	<b>TILT SPEED OF MOVEMENT:</b>	20°/s

<b>LIGHTING</b>	<b>LIGHT SOURCE:</b>	LED
	<b>MIN. DISTANCE FROM TARGET:</b>	N/A
	<b>MODULE LUMEN OUTPUT:</b>	594lm
	<b>ABSOLUTE LUMEN OUTPUT:</b>	540lm
	<b>GLARE MECHANICAL CUT-OFF:</b>	26°
	<b>GLARE COMFORT CUT-OFF:</b>	52°
<b>COLOUR TEMP:</b>	3000K	

<b>ELECTRICAL</b>	<b>VOLTAGE REGION:</b>	100 - 277V 50/60Hz
	<b>IEC PROTECTION CLASS:</b>	Class 2
	<b>LIGHT SOURCE WATTAGE:</b>	10W
	<b>MOVEMENT WATTAGE:</b>	3W
	<b>LUMINAIRE CIRCUIT WATTAGE:</b>	14W

PART NO. **DRX5.0008**

**PRODUCT SUMMARY**

DRX5 Spotlight; 100-277V 50/60Hz; Standard Trim Mounting; 4-Ø Optic; 3000K 80+CRI LED 10W; Black; Movement & Dimming using DMX Control only



# DRX5; Recessed - Standard LED 4° Optic 14W

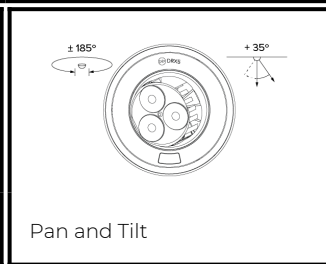
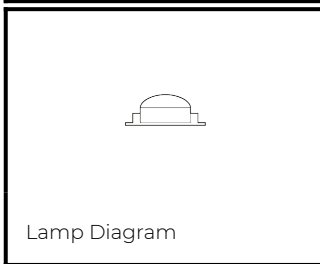
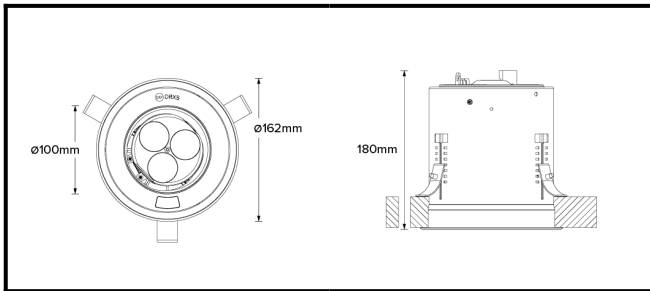

<b>PHYSICAL</b>	<b>CONSTRUCTION MATERIALS:</b>	LM24 Aluminium, Glass-filled Polycarbonate, Mild Steel mounting ring
	<b>MOUNTING:</b>	Recessed - Standard
	<b>WEIGHT:</b>	1.55kg
	<b>FINISH:</b>	Black RAL9005
	<b>MAX AMBIENT TEMPERATURE:</b>	40°C
	<b>CEILING CLEARANCE:</b>	200mm
	<b>CEILING CUT-OUT:</b>	145mm
	<b>CEILING THICKNESS:</b>	10-55mm

<b>CONTROL</b>	<b>MOVEMENT TYPE:</b>	Handheld Remote
	<b>DIMMING OPTION:</b>	DALI Dimming

**SPECIFICATION** DRX5 3000K LED (10W for light source) standard trim recessed luminaire with 4-° optic. Manufactured from LM24 aluminium and glass-filled polycarbonate, with a mild-steel mounting ring. Finished in black (RAL 9005). Voltage is 100-277V 50/60HZ. Luminaire has high-performance colour rendering of 80+ CRI. Luminaire can be rotated, with +/- 185-° movement through the pan axis and +35 through the tilt axis, at a resolution of less than 1-° in either axis. Movement is controlled using a handheld remote, and dimming is controlled using external DALI dimming. Recording and recalling of scenes as standard.

PART NO.

**DRX5.0009**
**PRODUCT SUMMARY**

DRX5 Spotlight; 100-277V 50/60Hz; Standard Trim Mounting; 4-° Optic; 3000K 80+CRI LED 10W; Black; Movement using Handheld Remote; Dimming Using External DALI Control

# DRX5; Recessed - Standard LED 4° Optic 14W

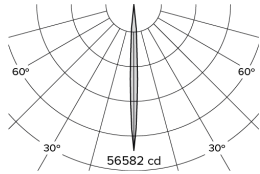

Photometry

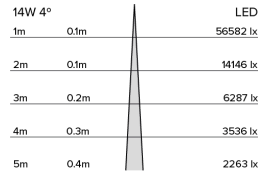

Cone Diagram

<b>MOVEMENT</b>	<b>MOVEMENT TYPE:</b>	Handheld Remote
	<b>PAN MOVEMENT RANGE:</b>	±185°
	<b>TILT MOVEMENT RANGE:</b>	+35°
	<b>PAN MOVEMENT RESOLUTION:</b>	<1°
	<b>TILT MOVEMENT RESOLUTION:</b>	<1°
	<b>PAN SPEED OF MOVEMENT:</b>	20°/s
	<b>TILT SPEED OF MOVEMENT:</b>	20°/s

<b>LIGHTING</b>	<b>LIGHT SOURCE:</b>	LED
	<b>MIN. DISTANCE FROM TARGET:</b>	N/A
	<b>MODULE LUMEN OUTPUT:</b>	594lm
	<b>ABSOLUTE LUMEN OUTPUT:</b>	540lm
	<b>GLARE MECHANICAL CUT-OFF:</b>	26°
	<b>GLARE COMFORT CUT-OFF:</b>	52°
<b>COLOUR TEMP:</b>	3000K	

<b>ELECTRICAL</b>	<b>VOLTAGE REGION:</b>	100 - 277V 50/60Hz
	<b>IEC PROTECTION CLASS:</b>	Class 2
	<b>LIGHT SOURCE WATTAGE:</b>	10W
	<b>MOVEMENT WATTAGE:</b>	3W
	<b>LUMINAIRE CIRCUIT WATTAGE:</b>	14W

PART NO.

**DRX5.0009**

**PRODUCT SUMMARY**

DRX5 Spotlight; 100-277V 50/60Hz; Standard Trim Mounting; 4-Ø Optic; 3000K 80+CRI LED 10W; Black; Movement using Handheld Remote; Dimming Using External DALI Control

# DRX5; Recessed - Standard LED 4° Optic 14W

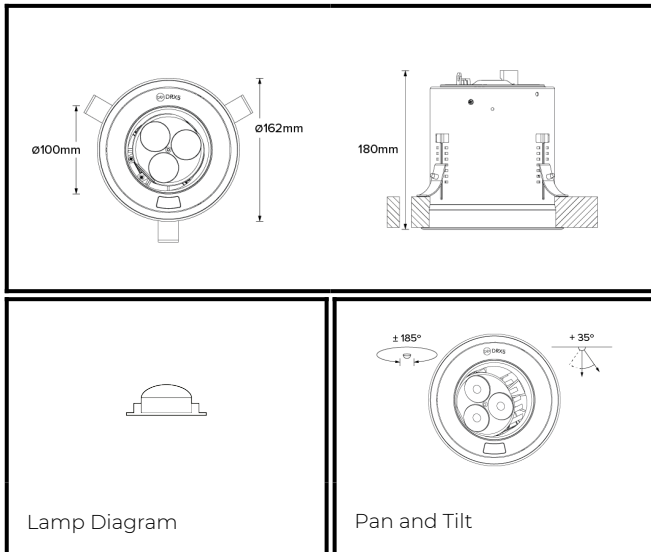

PHYSICAL	<b>CONSTRUCTION MATERIALS:</b>	LM24 Aluminium, Glass-filled Polycarbonate, Mild Steel mounting ring
	<b>MOUNTING:</b>	Recessed - Standard
	<b>WEIGHT:</b>	1.55kg
	<b>FINISH:</b>	Black RAL9005
	<b>MAX AMBIENT TEMPERATURE:</b>	40°C
	<b>CEILING CLEARANCE:</b>	200mm
	<b>CEILING CUT-OUT:</b>	145mm
<b>CEILING THICKNESS:</b>	10-55mm	

CONTROL	<b>MOVEMENT TYPE:</b>	Handheld Remote
	<b>DIMMING OPTION:</b>	1-10V

SPECIFICATION

DRX5 3000K LED (10W for light source) standard trim recessed luminaire with 4-° optic. Manufactured from LM24 aluminium and glass-filled polycarbonate, with a mild-steel mounting ring. Finished in black (RAL 9005). Voltage is 100-277V 50/60HZ. Luminaire has high-performance colour rendering of 80+ CRI. Luminaire can be rotated, with +/- 185-° movement through the pan axis and +35 through the tilt axis, at a resolution of less than 1-° in either axis. Movement is controlled using a handheld remote, and dimming is controlled using external 1-10V dimming. Recording and recalling of scenes as standard.

PART NO.

**DRX5.0010**

**PRODUCT SUMMARY**

DRX5 Spotlight; 100-277V 50/60Hz; Standard Trim Mounting; 4-° Optic; 3000K 80+CRI LED 10W; Black; Movement using Handheld Remote; Dimming Using External (1-10V)

# DRX5; Recessed - Standard LED 4° Optic 14W

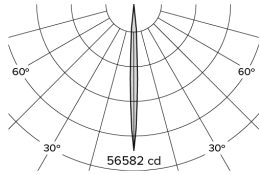

Photometry

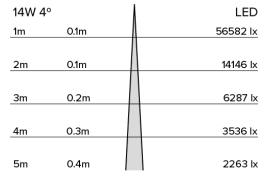

Cone Diagram

<b>MOVEMENT</b>	<b>MOVEMENT TYPE:</b>	Handheld Remote
	<b>PAN MOVEMENT RANGE:</b>	±185°
	<b>TILT MOVEMENT RANGE:</b>	+35°
	<b>PAN MOVEMENT RESOLUTION:</b>	<1°
	<b>TILT MOVEMENT RESOLUTION:</b>	<1°
	<b>PAN SPEED OF MOVEMENT:</b>	20°/s
	<b>TILT SPEED OF MOVEMENT:</b>	20°/s

<b>LIGHTING</b>	<b>LIGHT SOURCE:</b>	LED
	<b>MIN. DISTANCE FROM TARGET:</b>	N/A
	<b>MODULE LUMEN OUTPUT:</b>	594lm
	<b>ABSOLUTE LUMEN OUTPUT:</b>	540lm
	<b>GLARE MECHANICAL CUT-OFF:</b>	26°
	<b>GLARE COMFORT CUT-OFF:</b>	52°
<b>COLOUR TEMP:</b>	3000K	

<b>ELECTRICAL</b>	<b>VOLTAGE REGION:</b>	100 - 277V 50/60Hz
	<b>IEC PROTECTION CLASS:</b>	Class 2
	<b>LIGHT SOURCE WATTAGE:</b>	10W
	<b>MOVEMENT WATTAGE:</b>	3W
	<b>LUMINAIRE CIRCUIT WATTAGE:</b>	14W

PART NO. **DRX5.0010**

**PRODUCT SUMMARY**

DRX5 Spotlight; 100-277V 50/60Hz; Standard Trim Mounting; 4-Ø Optic; 3000K 80+CRI LED 10W; Black; Movement using Handheld Remote; Dimming Using External (1-10V)

# DRX5; Recessed - Standard LED 10° Optic 20W

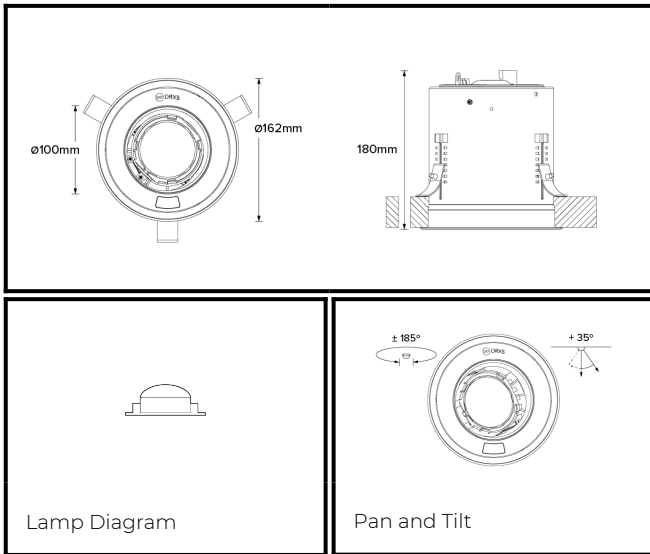

PHYSICAL	<b>CONSTRUCTION MATERIALS:</b>	LM24 Aluminium, Glass-filled Polycarbonate, Mild Steel mounting ring
	<b>MOUNTING:</b>	Recessed - Standard
	<b>WEIGHT:</b>	1.55kg
	<b>FINISH:</b>	White RAL9010
	<b>MAX AMBIENT TEMPERATURE:</b>	40°C
	<b>CEILING CLEARANCE:</b>	200mm
	<b>CEILING CUT-OUT:</b>	145mm
	<b>CEILING THICKNESS:</b>	10-55mm

CONTROL	<b>MOVEMENT TYPE:</b>	Handheld Remote
	<b>DIMMING OPTION:</b>	Handheld Control

SPECIFICATION

DRX5 3000K LED (17W for light source) standard trim recessed luminaire with 10-° optic. Manufactured from LM24 aluminium and glass-filled polycarbonate, with a mild-steel mounting ring. Finished in white (RAL 9010). Voltage is 100-277V 50/60HZ. Luminaire has high-performance colour rendering of 90+ CRI. Luminaire can be rotated, with +/- 185- movement through the pan axis and +35 through the tilt axis, at a resolution of less than 1- in either axis. Movement and dimming is controlled using a handheld remote. Recording and recalling of scenes as standard.

PART NO.

**DRX5.0011**

**PRODUCT SUMMARY**

DRX5 Spotlight; 100-277V 50/60Hz; Standard Trim Mounting; 10-° Optic; 3000K 90+CRI LED 17W; White; Movement & Dimming using Handheld Remote

# DRX5; Recessed - Standard LED 10° Optic 20W

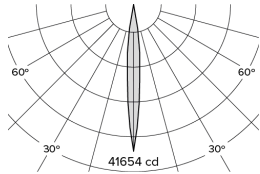

Photometry

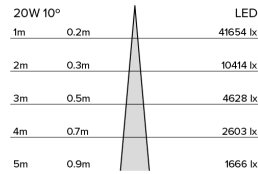

Cone Diagram

<b>MOVEMENT</b>	<b>MOVEMENT TYPE:</b>	Handheld Remote
	<b>PAN MOVEMENT RANGE:</b>	±185°
	<b>TILT MOVEMENT RANGE:</b>	+35°
	<b>PAN MOVEMENT RESOLUTION:</b>	<1°
	<b>TILT MOVEMENT RESOLUTION:</b>	<1°
	<b>PAN SPEED OF MOVEMENT:</b>	20°/s
	<b>TILT SPEED OF MOVEMENT:</b>	20°/s

<b>LIGHTING</b>	<b>LIGHT SOURCE:</b>	LED
	<b>MIN. DISTANCE FROM TARGET:</b>	N/A
	<b>MODULE LUMEN OUTPUT:</b>	1573lm
	<b>ABSOLUTE LUMEN OUTPUT:</b>	1430lm
	<b>GLARE MECHANICAL CUT-OFF:</b>	17°
	<b>GLARE COMFORT CUT-OFF:</b>	52°
<b>COLOUR TEMP:</b>	3000K	

<b>ELECTRICAL</b>	<b>VOLTAGE REGION:</b>	100 - 277V 50/60Hz
	<b>IEC PROTECTION CLASS:</b>	Class 2
	<b>LIGHT SOURCE WATTAGE:</b>	17W
	<b>MOVEMENT WATTAGE:</b>	3W
	<b>LUMINAIRE CIRCUIT WATTAGE:</b>	20W

PART NO. **DRX5.0011**

**PRODUCT SUMMARY**

DRX5 Spotlight; 100-277V 50/60Hz; Standard Trim Mounting; 10-° Optic; 3000K 90+CRI LED 17W; White; Movement & Dimming using Handheld Remote

# DRX5; Recessed - Standard LED 10° Optic 20W

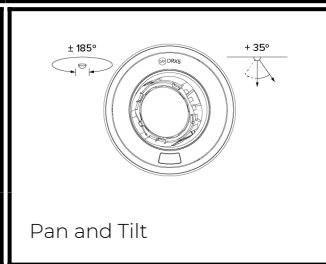
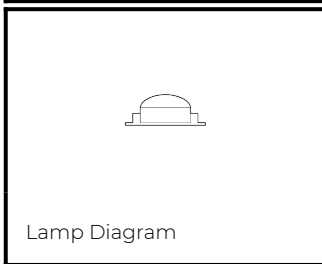
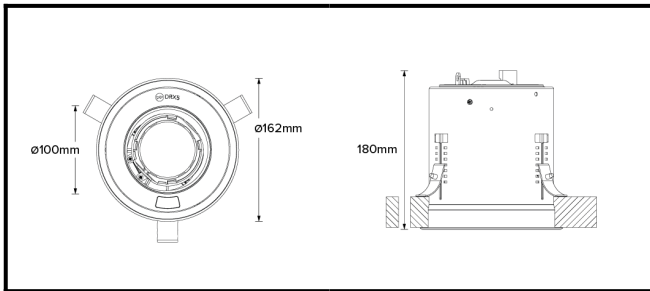

<b>PHYSICAL</b>	<b>CONSTRUCTION MATERIALS:</b>	LM24 Aluminium, Glass-filled Polycarbonate, Mild Steel mounting ring
	<b>MOUNTING:</b>	Recessed - Standard
	<b>WEIGHT:</b>	1.55kg
	<b>FINISH:</b>	White RAL9010
	<b>MAX AMBIENT TEMPERATURE:</b>	40°C
	<b>CEILING CLEARANCE:</b>	200mm
	<b>CEILING CUT-OUT:</b>	145mm
	<b>CEILING THICKNESS:</b>	10-55mm

<b>CONTROL</b>	<b>MOVEMENT TYPE:</b>	Handheld Remote
	<b>DIMMING OPTION:</b>	DMX

**SPECIFICATION** DRX5 3000K LED (17W for light source) standard trim recessed luminaire with 10-° optic. Manufactured from LM24 aluminium and glass-filled polycarbonate, with a mild-steel mounting ring. Finished in white (RAL 9010). Voltage is 100-277V 50/60HZ. Luminaire has high-performance colour rendering of 90+ CRI. Luminaire can be rotated, with +/- 185- movement through the pan axis and +35 through the tilt axis, at a resolution of less than 1- in either axis. Movement is controlled using a handheld remote, and dimming is controlled using DMX Recording and recalling of scenes as standard.

PART NO.

**DRX5.0012**
**PRODUCT SUMMARY**

DRX5 Spotlight; 100-277V 50/60Hz; Standard Trim Mounting; 10-° Optic; 3000K 90+CRI LED 17W; White; Movement using Handheld Remote; Dimming using DMX Control

# DRX5; Recessed - Standard LED 10° Optic 20W

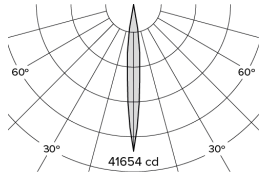

Photometry

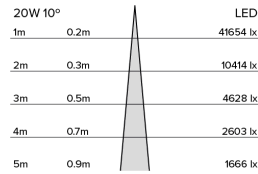

Cone Diagram

<b>MOVEMENT</b>	<b>MOVEMENT TYPE:</b>	Handheld Remote
	<b>PAN MOVEMENT RANGE:</b>	±185°
	<b>TILT MOVEMENT RANGE:</b>	+35°
	<b>PAN MOVEMENT RESOLUTION:</b>	<1°
	<b>TILT MOVEMENT RESOLUTION:</b>	<1°
	<b>PAN SPEED OF MOVEMENT:</b>	20°/s
	<b>TILT SPEED OF MOVEMENT:</b>	20°/s

<b>LIGHTING</b>	<b>LIGHT SOURCE:</b>	LED
	<b>MIN. DISTANCE FROM TARGET:</b>	N/A
	<b>MODULE LUMEN OUTPUT:</b>	1573lm
	<b>ABSOLUTE LUMEN OUTPUT:</b>	1430lm
	<b>GLARE MECHANICAL CUT-OFF:</b>	17°
	<b>GLARE COMFORT CUT-OFF:</b>	52°
<b>COLOUR TEMP:</b>	3000K	

<b>ELECTRICAL</b>	<b>VOLTAGE REGION:</b>	100 - 277V 50/60Hz
	<b>IEC PROTECTION CLASS:</b>	Class 2
	<b>LIGHT SOURCE WATTAGE:</b>	17W
	<b>MOVEMENT WATTAGE:</b>	3W
	<b>LUMINAIRE CIRCUIT WATTAGE:</b>	20W

PART NO. **DRX5.0012**

**PRODUCT SUMMARY**

DRX5 Spotlight; 100-277V 50/60Hz; Standard Trim Mounting; 10-° Optic; 3000K 90+CRI LED 17W; White; Movement using Handheld Remote; Dimming using DMX Control



# DRX5; Recessed - Standard LED 10° Optic 20W

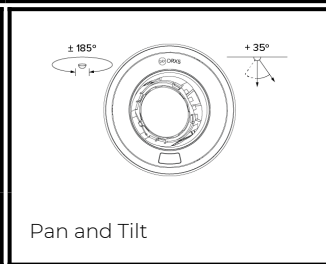
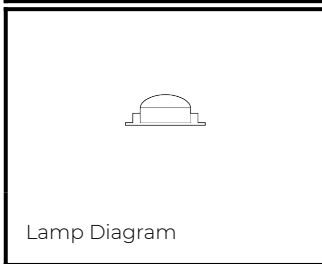
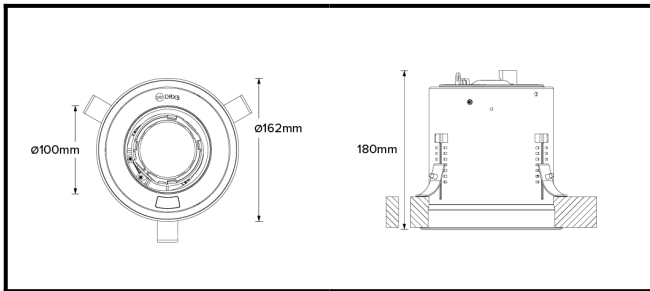

<b>PHYSICAL</b>	<b>CONSTRUCTION MATERIALS:</b>	LM24 Aluminium, Glass-filled Polycarbonate, Mild Steel mounting ring
	<b>MOUNTING:</b>	Recessed - Standard
	<b>WEIGHT:</b>	1.55kg
	<b>FINISH:</b>	White RAL9010
	<b>MAX AMBIENT TEMPERATURE:</b>	40°C
	<b>CEILING CLEARANCE:</b>	200mm
	<b>CEILING CUT-OUT:</b>	145mm
	<b>CEILING THICKNESS:</b>	10-55mm

<b>CONTROL</b>	<b>MOVEMENT TYPE:</b>	DMX
	<b>DIMMING OPTION:</b>	DMX

**SPECIFICATION** DRX5 3000K LED (17W for light source) standard trim recessed luminaire with 10-° optic. Manufactured from LM24 aluminium and glass-filled polycarbonate, with a mild-steel mounting ring. Finished in white (RAL 9010). Voltage is 100-277V 50/60HZ. Luminaire has high-performance colour rendering of 90+ CRI. Luminaire can be rotated, with +/- 185- movement through the pan axis and +35 through the tilt axis, at a resolution of less than 1- in either axis. Movement and dimming is controlled by DMX. Recording and recalling of scenes as standard.

PART NO.

**DRX5.0013**
**PRODUCT SUMMARY**

DRX5 Spotlight; 100-277V 50/60Hz; Standard Trim Mounting; 10-° Optic; 3000K 90+CRI LED 17W; White; Movement &amp; Dimming using DMX Control only

# DRX5; Recessed - Standard LED 10° Optic 20W

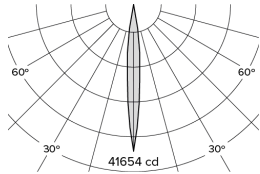

Photometry

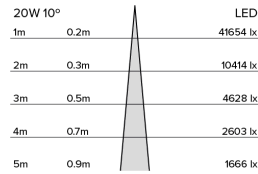

Cone Diagram

<b>MOVEMENT</b>	<b>MOVEMENT TYPE:</b>	DMX
	<b>PAN MOVEMENT RANGE:</b>	±185°
	<b>TILT MOVEMENT RANGE:</b>	+35°
	<b>PAN MOVEMENT RESOLUTION:</b>	<1°
	<b>TILT MOVEMENT RESOLUTION:</b>	<1°
	<b>PAN SPEED OF MOVEMENT:</b>	20°/s
	<b>TILT SPEED OF MOVEMENT:</b>	20°/s

<b>LIGHTING</b>	<b>LIGHT SOURCE:</b>	LED
	<b>MIN. DISTANCE FROM TARGET:</b>	N/A
	<b>MODULE LUMEN OUTPUT:</b>	1573lm
	<b>ABSOLUTE LUMEN OUTPUT:</b>	1430lm
	<b>GLARE MECHANICAL CUT-OFF:</b>	17°
	<b>GLARE COMFORT CUT-OFF:</b>	52°
	<b>COLOUR TEMP:</b>	3000K

<b>ELECTRICAL</b>	<b>VOLTAGE REGION:</b>	100 - 277V 50/60Hz
	<b>IEC PROTECTION CLASS:</b>	Class 2
	<b>LIGHT SOURCE WATTAGE:</b>	17W
	<b>MOVEMENT WATTAGE:</b>	3W
	<b>LUMINAIRE CIRCUIT WATTAGE:</b>	20W

PART NO. **DRX5.0013**

**PRODUCT SUMMARY**

DRX5 Spotlight; 100-277V 50/60Hz; Standard Trim Mounting; 10-° Optic; 3000K 90+CRI LED 17W; White; Movement & Dimming using DMX Control only

# DRX5; Recessed - Standard LED 10° Optic 20W

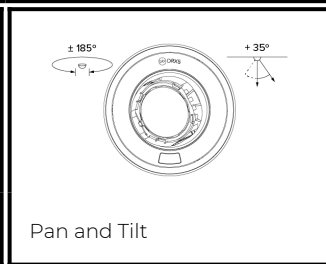
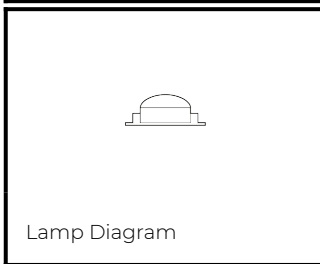
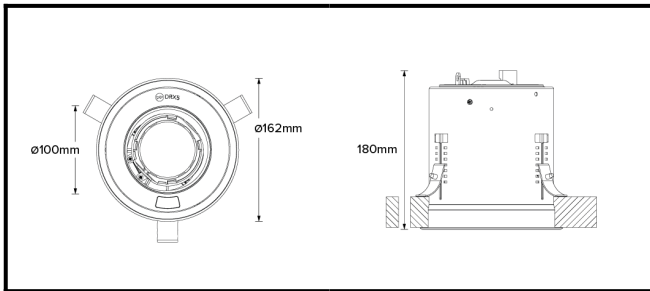

<b>PHYSICAL</b>	<b>CONSTRUCTION MATERIALS:</b>	LM24 Aluminium, Glass-filled Polycarbonate, Mild Steel mounting ring
	<b>MOUNTING:</b>	Recessed - Standard
	<b>WEIGHT:</b>	1.55kg
	<b>FINISH:</b>	White RAL9010
	<b>MAX AMBIENT TEMPERATURE:</b>	40°C
	<b>CEILING CLEARANCE:</b>	200mm
	<b>CEILING CUT-OUT:</b>	145mm
	<b>CEILING THICKNESS:</b>	10-55mm

<b>CONTROL</b>	<b>MOVEMENT TYPE:</b>	Handheld Remote
	<b>DIMMING OPTION:</b>	DALI Dimming

**SPECIFICATION** DRX5 3000K LED (17W for light source) standard trim recessed luminaire with 10-° optic. Manufactured from LM24 aluminium and glass-filled polycarbonate, with a mild-steel mounting ring. Finished in white (RAL 9010). Voltage is 100-277V 50/60HZ. Luminaire has high-performance colour rendering of 90+ CRI. Luminaire can be rotated, with +/- 185- movement through the pan axis and +35 through the tilt axis, at a resolution of less than 1- in either axis. Movement is controlled using a handheld remote, and dimming is controlled using external DALI dimming. Recording and recalling of scenes as standard.

PART NO.

**DRX5.0014**
**PRODUCT SUMMARY**

DRX5 Spotlight; 100-277V 50/60Hz; Standard Trim Mounting; 10-° Optic; 3000K 90+CRI LED 17W; White; Movement using Handheld Remote; Dimming Using External DALI Control

# DRX5; Recessed - Standard LED 10° Optic 20W

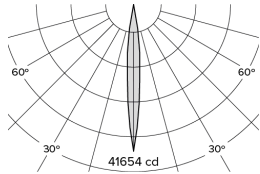

Photometry

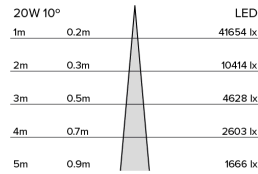

Cone Diagram

<b>MOVEMENT</b>	<b>MOVEMENT TYPE:</b>	Handheld Remote
	<b>PAN MOVEMENT RANGE:</b>	±185°
	<b>TILT MOVEMENT RANGE:</b>	+35°
	<b>PAN MOVEMENT RESOLUTION:</b>	<1°
	<b>TILT MOVEMENT RESOLUTION:</b>	<1°
	<b>PAN SPEED OF MOVEMENT:</b>	20°/s
	<b>TILT SPEED OF MOVEMENT:</b>	20°/s

<b>LIGHTING</b>	<b>LIGHT SOURCE:</b>	LED
	<b>MIN. DISTANCE FROM TARGET:</b>	N/A
	<b>MODULE LUMEN OUTPUT:</b>	1573lm
	<b>ABSOLUTE LUMEN OUTPUT:</b>	1430lm
	<b>GLARE MECHANICAL CUT-OFF:</b>	17°
	<b>GLARE COMFORT CUT-OFF:</b>	52°
<b>COLOUR TEMP:</b>	3000K	

<b>ELECTRICAL</b>	<b>VOLTAGE REGION:</b>	100 - 277V 50/60Hz
	<b>IEC PROTECTION CLASS:</b>	Class 2
	<b>LIGHT SOURCE WATTAGE:</b>	17W
	<b>MOVEMENT WATTAGE:</b>	3W
	<b>LUMINAIRE CIRCUIT WATTAGE:</b>	20W

PART NO. DRX5.0014

**PRODUCT SUMMARY**

DRX5 Spotlight; 100-277V 50/60Hz; Standard Trim Mounting; 10-° Optic; 3000K 90+CRI LED 17W; White; Movement using Handheld Remote; Dimming Using External DALI Control

# DRX5; Recessed - Standard LED 22° Optic 20W

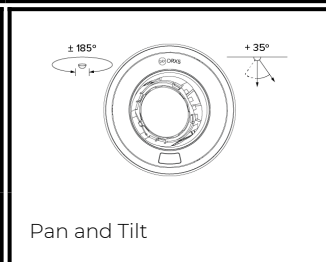
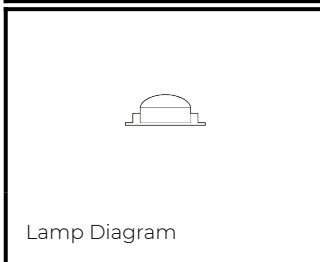
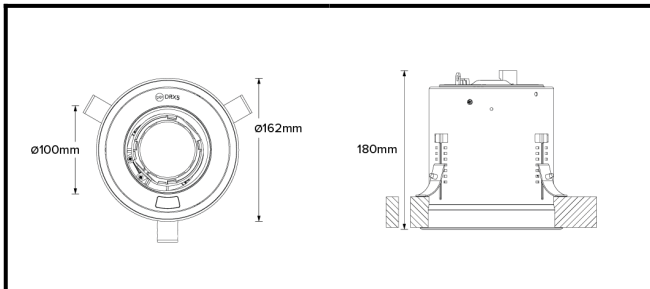

<b>PHYSICAL</b>	<b>CONSTRUCTION MATERIALS:</b>	LM24 Aluminium, Glass-filled Polycarbonate, Mild Steel mounting ring
	<b>MOUNTING:</b>	Recessed - Standard
	<b>WEIGHT:</b>	1.55kg
	<b>FINISH:</b>	White RAL9010
	<b>MAX AMBIENT TEMPERATURE:</b>	40°C
	<b>CEILING CLEARANCE:</b>	200mm
	<b>CEILING CUT-OUT:</b>	145mm
	<b>CEILING THICKNESS:</b>	10-55mm

<b>CONTROL</b>	<b>MOVEMENT TYPE:</b>	Handheld Remote
	<b>DIMMING OPTION:</b>	DALI Dimming

**SPECIFICATION** DRX5 3000K LED (17W for light source) standard trim recessed luminaire with 22-° optic. Manufactured from LM24 aluminium and glass-filled polycarbonate, with a mild-steel mounting ring. Finished in white (RAL 9010). Voltage is 100-277V 50/60HZ. Luminaire has high-performance colour rendering of 90+ CRI. Luminaire can be rotated, with +/- 185-° movement through the pan axis and +35 through the tilt axis, at a resolution of less than 1-° in either axis. Movement is controlled using a handheld remote, and dimming is controlled using external DALI dimming. Recording and recalling of scenes as standard.

PART NO.

**DRX5.0024**
**PRODUCT SUMMARY**

DRX5 Spotlight; 100-277V 50/60Hz; Standard Trim Mounting; 22-° Optic; 3000K 90+CRI LED 17W; White; Movement using Handheld Remote; Dimming Using External DALI Control

# DRX5; Recessed - Standard LED 22° Optic 20W

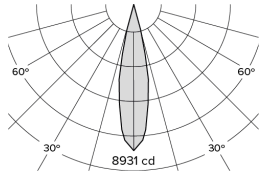

Photometry

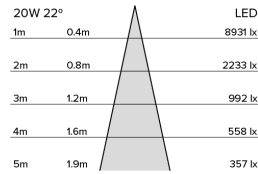

Cone Diagram

<b>MOVEMENT</b>	<b>MOVEMENT TYPE:</b>	Handheld Remote
	<b>PAN MOVEMENT RANGE:</b>	±185°
	<b>TILT MOVEMENT RANGE:</b>	+35°
	<b>PAN MOVEMENT RESOLUTION:</b>	<1°
	<b>TILT MOVEMENT RESOLUTION:</b>	<1°
	<b>PAN SPEED OF MOVEMENT:</b>	20°/s
	<b>TILT SPEED OF MOVEMENT:</b>	20°/s

<b>LIGHTING</b>	<b>LIGHT SOURCE:</b>	LED
	<b>MIN. DISTANCE FROM TARGET:</b>	N/A
	<b>MODULE LUMEN OUTPUT:</b>	1518lm
	<b>ABSOLUTE LUMEN OUTPUT:</b>	1380lm
	<b>GLARE MECHANICAL CUT-OFF:</b>	17°
	<b>GLARE COMFORT CUT-OFF:</b>	52°
<b>COLOUR TEMP:</b>	3000K	

<b>ELECTRICAL</b>	<b>VOLTAGE REGION:</b>	100 - 277V 50/60Hz
	<b>IEC PROTECTION CLASS:</b>	Class 2
	<b>LIGHT SOURCE WATTAGE:</b>	17W
	<b>MOVEMENT WATTAGE:</b>	3W
	<b>LUMINAIRE CIRCUIT WATTAGE:</b>	20W

PART NO.

**DRX5.0024**

**PRODUCT SUMMARY**

DRX5 Spotlight; 100-277V 50/60Hz; Standard Trim Mounting; 22-°Optic; 3000K 90+CRI LED 17W; White; Movement using Handheld Remote; Dimming Using External DALI Control

# DRX5; Recessed - Standard LED 22° Optic 20W

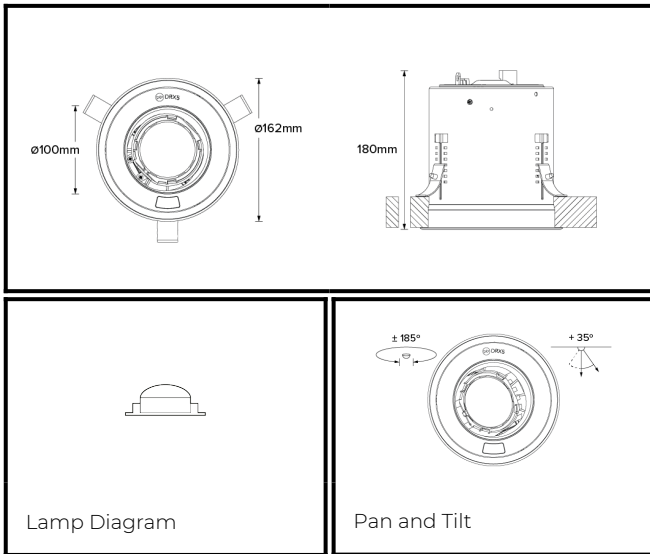

PHYSICAL	<b>CONSTRUCTION MATERIALS:</b>	LM24 Aluminium, Glass-filled Polycarbonate, Mild Steel mounting ring
	<b>MOUNTING:</b>	Recessed - Standard
	<b>WEIGHT:</b>	1.55kg
	<b>FINISH:</b>	White RAL9010
	<b>MAX AMBIENT TEMPERATURE:</b>	40°C
	<b>CEILING CLEARANCE:</b>	200mm
	<b>CEILING CUT-OUT:</b>	145mm
	<b>CEILING THICKNESS:</b>	10-55mm

CONTROL	<b>MOVEMENT TYPE:</b>	Handheld Remote
	<b>DIMMING OPTION:</b>	1-10V

SPECIFICATION

DRX5 3000K LED (17W for light source) standard trim recessed luminaire with 22-° optic. Manufactured from LM24 aluminium and glass-filled polycarbonate, with a mild-steel mounting ring. Finished in white (RAL 9010). Voltage is 100-277V 50/60HZ. Luminaire has high-performance colour rendering of 90+ CRI. Luminaire can be rotated, with +/- 185- movement through the pan axis and +35 through the tilt axis, at a resolution of less than 1- in either axis. Movement is controlled using a handheld remote, and dimming is controlled using external 1-10V dimming. Recording and recalling of scenes as standard.

PART NO.

**DRX5.0025**

**PRODUCT SUMMARY**

DRX5 Spotlight; 100-277V 50/60Hz; Standard Trim Mounting; 22-° Optic; 3000K 90+CRI LED 17W; White; Movement using Handheld Remote; Dimming Using External (1-10V)

# DRX5; Recessed - Standard LED 22° Optic 20W

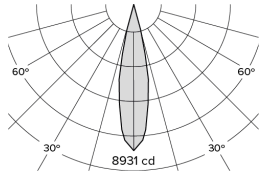

Photometry

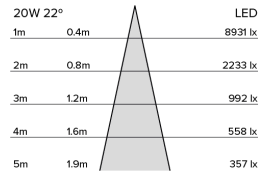

Cone Diagram

<b>MOVEMENT</b>	<b>MOVEMENT TYPE:</b>	Handheld Remote
	<b>PAN MOVEMENT RANGE:</b>	±185°
	<b>TILT MOVEMENT RANGE:</b>	+35°
	<b>PAN MOVEMENT RESOLUTION:</b>	<1°
	<b>TILT MOVEMENT RESOLUTION:</b>	<1°
	<b>PAN SPEED OF MOVEMENT:</b>	20°/s
	<b>TILT SPEED OF MOVEMENT:</b>	20°/s

<b>LIGHTING</b>	<b>LIGHT SOURCE:</b>	LED
	<b>MIN. DISTANCE FROM TARGET:</b>	N/A
	<b>MODULE LUMEN OUTPUT:</b>	1518lm
	<b>ABSOLUTE LUMEN OUTPUT:</b>	1380lm
	<b>GLARE MECHANICAL CUT-OFF:</b>	17°
	<b>GLARE COMFORT CUT-OFF:</b>	52°
<b>COLOUR TEMP:</b>	3000K	

<b>ELECTRICAL</b>	<b>VOLTAGE REGION:</b>	100 - 277V 50/60Hz
	<b>IEC PROTECTION CLASS:</b>	Class 2
	<b>LIGHT SOURCE WATTAGE:</b>	17W
	<b>MOVEMENT WATTAGE:</b>	3W
	<b>LUMINAIRE CIRCUIT WATTAGE:</b>	20W

PART NO. DRX5.0025

**PRODUCT SUMMARY**

DRX5 Spotlight; 100-277V 50/60Hz; Standard Trim Mounting; 22-°Optic; 3000K 90+CRI LED 17W; White; Movement using Handheld Remote; Dimming Using External (1-10V)