

Indoor | Pendants | Yori Pendant Ghostrack Ø22mm

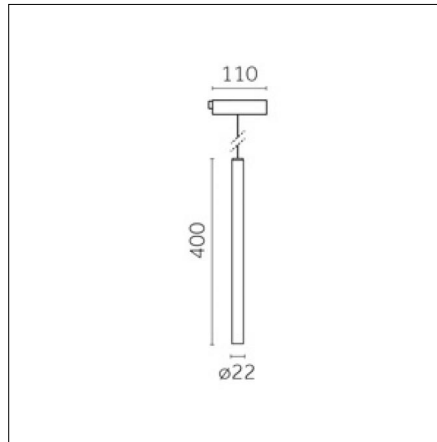

Very narrow 10°

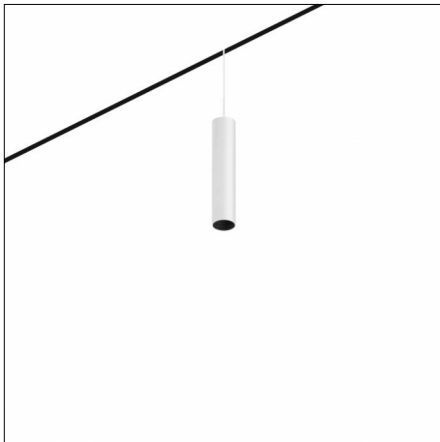

IP20



Risk 1

850°



**Code X.BM70B.HQD0**

### Light source features

**Number of light sources:** 1

**Source type:** LED HQ

**Watt:** 2W

**Lm:** 145lm

**Lm/W:** 73lm/W

**Kelvin/CRI:** 3000K / >90

**SDCM/L90 B10:** < 3 / 50000

### Electrical features

**Driver included:** NO

**Driver position:** remote

**Driver type:** no driver included

**Isolation class:** Class III

### Optical features

**Beam angle:** 10°

**Optical type, adjustability:** Fixed

**Interchangeable optic (IOS):** NO

### Physical features

**Material:** Die-cast aluminum

**Mounting:** Track, Suspension

**Finishing:** Brushed brass

**Weight:** 0.4Kg

### Notes:

Cable length 3m

Luminaire constructed in conformity with Directives 2014/35/EU (LV), 2014/30/EU (EMC), 2009/125/EC (Ecodesign) with Regulations (EC) No 245/2009, (EU) No 347/2010 and (EU) 2015/1428 (for luminaires with fluorescent and metal halide lamps only), 2009/125/EC (Ecodesign) with Regulations (EU) No 1194/2012 and 2015/1428 (for LED luminaires only), 2011/65/EU (RoHS 2) and 2012/19/EU (WEEE).

### Reggiani SPA Illuminazione

Viale Monza, 16 20845 Sovico (MB) Italy  
Tel. (+39) 039 2071.1 fax (+39) 039 2071 999

www.reggiani.net  
contact@reggiani.net

## Photometries



## Tracks/channels

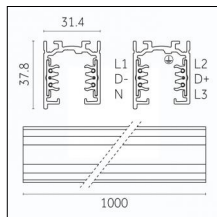
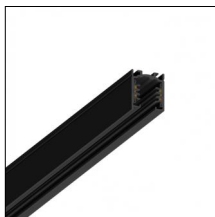

**Code 0.02030.0010 - 3-circuit track surface/pendant**

Finishing: White (Standard)  
Length: 1000mm Width: 31.4mm Height: 37.8mm

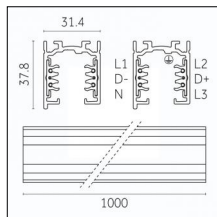

**Code 0.02030.0021 - 3-circuit track surface/pendant**

Finishing: Black (Standard)  
Length: 1000mm Width: 31.4mm Height: 37.8mm

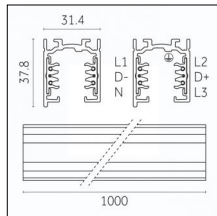

**Code 0.02030.0028 - 3-circuit track surface/pendant**

Finishing: Metallised grey (Standard)  
Length: 1000mm Width: 31.4mm Height: 37.8mm

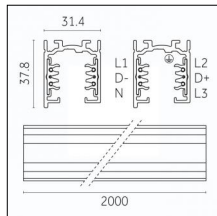

**Code 0.02031.0010 - 3-circuit track surface/pendant**

Finishing: White (Standard)  
Length: 2000mm Width: 31.4mm Height: 37.8mm

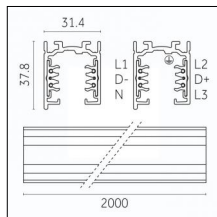
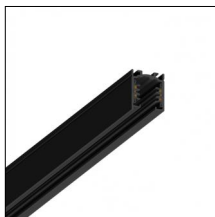

**Code 0.02031.0021 - 3-circuit track surface/pendant**

Finishing: Black (Standard)  
Length: 2000mm Width: 31.4mm Height: 37.8mm

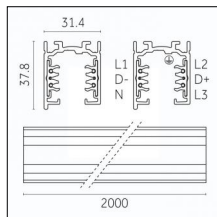

**Code 0.02031.0028 - 3-circuit track surface/pendant**

Finishing: Metallised grey (Standard)  
Length: 2000mm Width: 31.4mm Height: 37.8mm

Luminaire constructed in conformity with Directives 2014/35/EU (LV), 2014/30/EU (EMC), 2009/125/EC (Ecodesign) with Regulations (EC) No 245/2009, (EU) No 347/2010 and (EU) 2015/1428 (for luminaires with fluorescent and metal halide lamps only), 2009/125/EC (Ecodesign) with Regulations (EU) No 1194/2012 and 2015/1428 (for LED luminaires only), 2011/65/EU (RoHS 2) and 2012/19/EU (WEEE).

## Tracks/channels

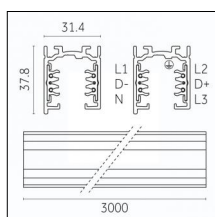

### Code 0.02032.0010 - 3-circuit track surface/pendant

Finishing: White (Standard)  
Length: 3000mm Width: 31.4mm Height: 37.8mm

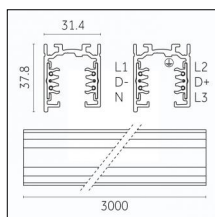
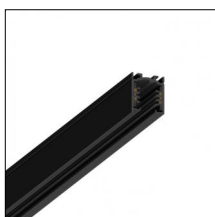

### Code 0.02032.0021 - 3-circuit track surface/pendant

Finishing: Black (Standard)  
Length: 3000mm Width: 31.4mm Height: 37.8mm

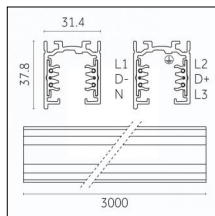
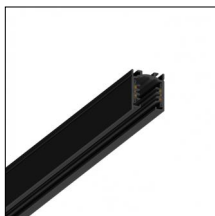

### Code 0.02032.0028 - 3-circuit track surface/pendant

Finishing: Metallised grey (Standard)  
Length: 3000mm Width: 31.4mm Height: 37.8mm

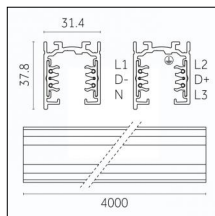
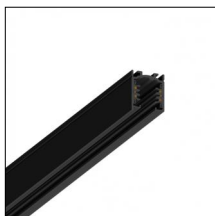

### Code 0.02033.0010 - 3-circuit track surface/pendant

Finishing: White (Standard)  
Length: 4000mm Width: 31.4mm Height: 37.8mm

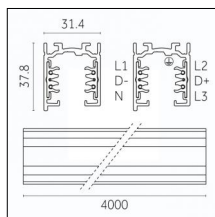

### Code 0.02033.0021 - 3-circuit track surface/pendant

Finishing: Black (Standard)  
Length: 4000mm Width: 31.4mm Height: 37.8mm

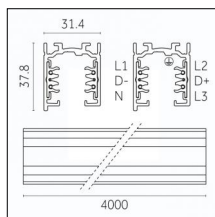

### Code 0.02033.0028 - 3-circuit track surface/pendant

Finishing: Metallised grey (Standard)  
Length: 4000mm Width: 31.4mm Height: 37.8mm

Luminaire constructed in conformity with Directives 2014/35/EU (LV), 2014/30/EU (EMC), 2009/125/EC (Ecodesign) with Regulations (EC) No 245/2009, (EU) No 347/2010 and (EU) 2015/1428 (for luminaires with fluorescent and metal halide lamps only), 2009/125/EC (Ecodesign) with Regulations (EU) No 1194/2012 and 2015/1428 (for LED luminaires only), 2011/65/EU (RoHS 2) and 2012/19/EU (WEEE).



## Tracks/channels

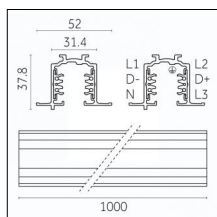

**Code 0.02034.0010 - 3-circuit track recessed**

Finishing: White (Standard)  
Length: 1000mm Width: 52mm Height: 37.8mm

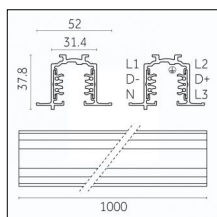

**Code 0.02034.0021 - 3-circuit track recessed**

Finishing: Black (Standard)  
Length: 1000mm Width: 52mm Height: 37.8mm

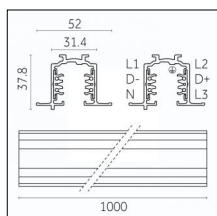

**Code 0.02034.0028 - 3-circuit track recessed**

Finishing: Metallised grey (Standard)  
Length: 1000mm Width: 52mm Height: 37.8mm

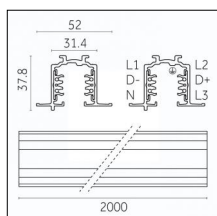

**Code 0.02035.0010 - 3-circuit track recessed**

Finishing: White (Standard)  
Length: 2000mm Width: 52mm Height: 37.8mm

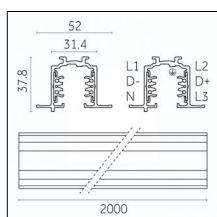

**Code 0.02035.0021 - 3-circuit track recessed**

Finishing: Black (Standard)  
Length: 2000mm Width: 52mm Height: 37.8mm

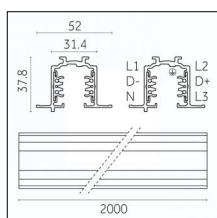

**Code 0.02035.0028 - 3-circuit track recessed**

Finishing: Metallised grey (Standard)  
Length: 2000mm Width: 52mm Height: 37.8mm

Luminaire constructed in conformity with Directives 2014/35/EU (LV), 2014/30/EU (EMC), 2009/125/EC (Ecodesign) with Regulations (EC) No 245/2009, (EU) No 347/2010 and (EU) 2015/1428 (for luminaires with fluorescent and metal halide lamps only), 2009/125/EC (Ecodesign) with Regulations (EU) No 1194/2012 and 2015/1428 (for LED luminaires only), 2011/65/EU (RoHS 2) and 2012/19/EU (WEEE).

## Tracks/channels

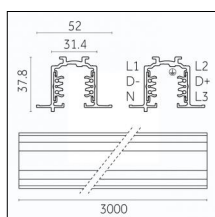

### Code 0.02036.0010 - 3-circuit track recessed

Finishing: White (Standard)  
Length: 3000mm Width: 52mm Height: 37.8mm

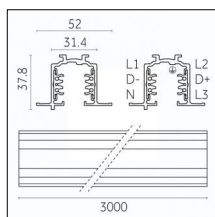

### Code 0.02036.0021 - 3-circuit track recessed

Finishing: Black (Standard)  
Length: 3000mm Width: 52mm Height: 37.8mm

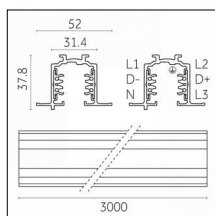

### Code 0.02036.0028 - 3-circuit track recessed

Finishing: Metallised grey (Standard)  
Length: 3000mm Width: 52mm Height: 37.8mm

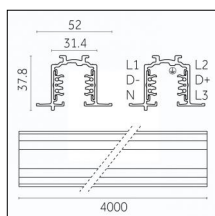

### Code 0.02037.0010 - 3-circuit track recessed

Finishing: White (Standard)  
Length: 4000mm Width: 52mm Height: 37.8mm

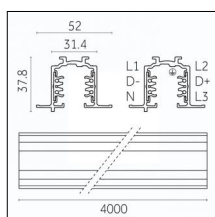

### Code 0.02037.0021 - 3-circuit track recessed

Finishing: Black (Standard)  
Length: 4000mm Width: 52mm Height: 37.8mm

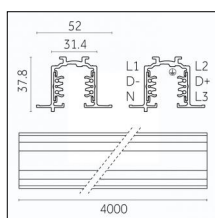

### Code 0.02037.0028 - 3-circuit track recessed

Finishing: Metallised grey (Standard)  
Length: 4000mm Width: 52mm Height: 37.8mm

Luminaire constructed in conformity with Directives 2014/35/EU (LV), 2014/30/EU (EMC), 2009/125/EC (Ecodesign) with Regulations (EC) No 245/2009, (EU) No 347/2010 and (EU) 2015/1428 (for luminaires with fluorescent and metal halide lamps only), 2009/125/EC (Ecodesign) with Regulations (EU) No 1194/2012 and 2015/1428 (for LED luminaires only), 2011/65/EU (RoHS 2) and 2012/19/EU (WEEE).

## Tracks/channels

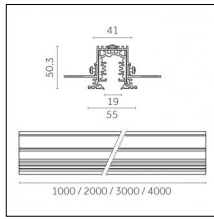

### Code 0.27101.0021 - 3-circuit track Supertrack

Finishing: Black (Standard)  
Length: 1000mm Width: 41mm Height: 50mm

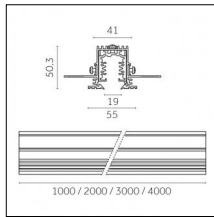

### Code 0.27102.0021 - 3-circuit track Supertrack

Finishing: Black (Standard)  
Length: 2000mm Width: 41mm Height: 50mm

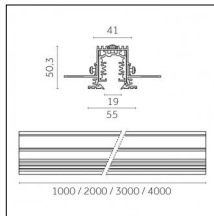

### Code 0.27103.0021 - 3-circuit track Supertrack

Finishing: Black (Standard)  
Length: 3000mm Width: 41mm Height: 50mm

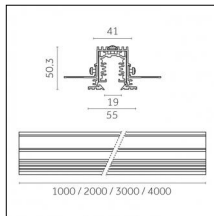

### Code 0.27104.0021 - 3-circuit track Supertrack

Finishing: Black (Standard)  
Length: 4000mm Width: 41mm Height: 50mm

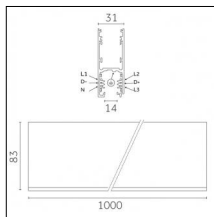
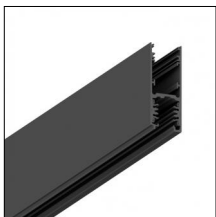

### Code 0.02505.0010 - H Track | Surface/Pendant

Finishing: White (Standard)  
Length: 1000mm Width: 31mm Height: 83mm

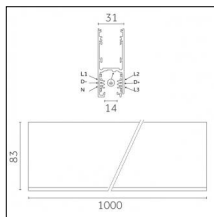
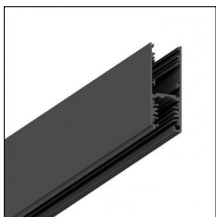

### Code 0.02505.0021 - H Track | Surface/Pendant

Finishing: Black (Standard)  
Length: 1000mm Width: 31mm Height: 83mm

Luminaire constructed in conformity with Directives 2014/35/EU (LV), 2014/30/EU (EMC), 2009/125/EC (Ecodesign) with Regulations (EC) No 245/2009, (EU) No 347/2010 and (EU) 2015/1428 (for luminaires with fluorescent and metal halide lamps only), 2009/125/EC (Ecodesign) with Regulations (EU) No 1194/2012 and 2015/1428 (for LED luminaires only), 2011/65/EU (RoHS 2) and 2012/19/EU (WEEE).

## Tracks/channels

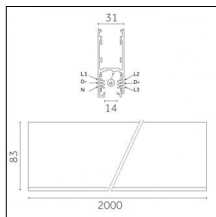

### Code 0.02506.0010 - H Track | Surface/Pendant

Finishing: White (Standard)  
Length: 2000mm Width: 31mm Height: 83mm

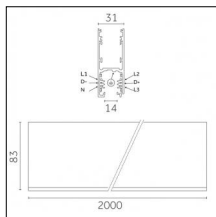

### Code 0.02506.0021 - H Track | Surface/Pendant

Finishing: Black (Standard)  
Length: 2000mm Width: 31mm Height: 83mm

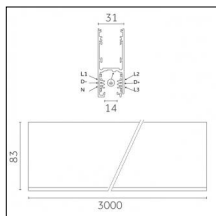

### Code 0.02507.0010 - H Track | Surface/Pendant

Finishing: White (Standard)  
Length: 3000mm Width: 31mm Height: 83mm

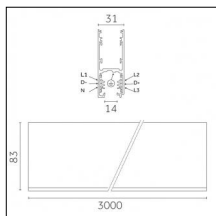
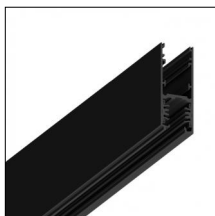

### Code 0.02507.0021 - H Track | Surface/Pendant

Finishing: Black (Standard)  
Length: 3000mm Width: 31mm Height: 83mm

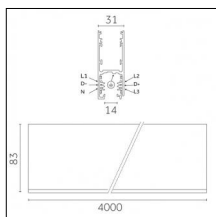

### Code 0.02508.0010 - H Track | Surface/Pendant

Finishing: White (Standard)  
Length: 4000mm Width: 31mm Height: 83mm

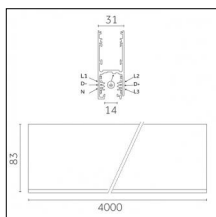

### Code 0.02508.0021 - H Track | Surface/Pendant

Finishing: Black (Standard)  
Length: 4000mm Width: 31mm Height: 83mm

Luminaire constructed in conformity with Directives 2014/35/EU (LV), 2014/30/EU (EMC), 2009/125/EC (Ecodesign) with Regulations (EC) No 245/2009, (EU) No 347/2010 and (EU) 2015/1428 (for luminaires with fluorescent and metal halide lamps only), 2009/125/EC (Ecodesign) with Regulations (EU) No 1194/2012 and 2015/1428 (for LED luminaires only), 2011/65/EU (RoHS 2) and 2012/19/EU (WEEE).

## Driver

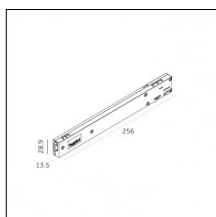

### Code 0.30457.0000 - Driver

Type: On-Off

Watt: 35W - AC Input: 220-240Vac - mA:700mA

Description: Connection options:

1X: 9-15pz

2X: 3-5pz

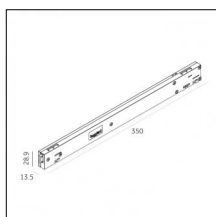

### Code D.30457.0000 - Driver

Type: DALI

Watt: 35W - AC Input: 120-277Vac - mA:700mA

Description: Connection options:

1X: 3-15pz

2X: 1-5pz

## Accessories

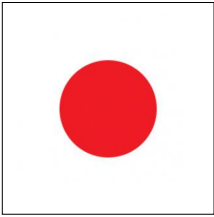

**Code 0.26700.004A - Red glass filter 1 mm**

Type: Optical  
Finishing: Red

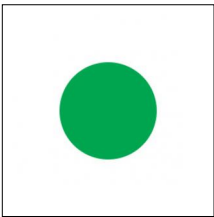

**Code 0.26700.005A - Green glass filter 1 mm**

Type: Optical  
Finishing: Green

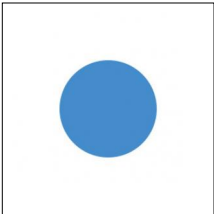

**Code 0.26700.006A - Blue glass filter 1 mm**

Type: Optical  
Finishing: Blue

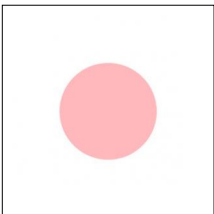

**Code 0.26700.007A - Pink glass filter 1 mm**

Type: Optical  
Finishing: Pink

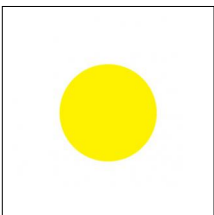

**Code 0.26700.008A - Yellow glass filter 1 mm**

Type: Optical  
Finishing: Yellow

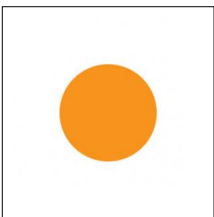

**Code 0.26700.009A - Orange glass filter 1 mm**

Type: Optical  
Finishing: Orange

## Accessories

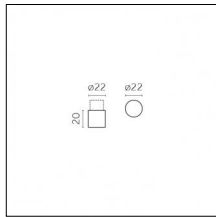

### Code 0.26040.0000 - Cylinder, Full version

Type: Optical  
 Finishing: Without finish / Stainles Steel / Natural aluminium (Standard)  
 Height: 22mm  
 Description: Full version

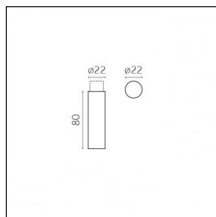
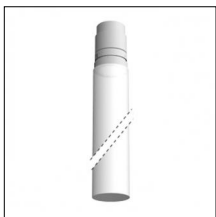

### Code 0.26041.0000 - Cylinder, Full version

Type: Optical  
 Finishing: Without finish / Stainles Steel / Natural aluminium (Standard)  
 Height: 80mm  
 Description: Full version

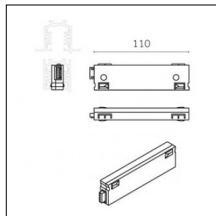

### Code 0.26500.0000 - Standard spacer - 110mm

Type: Structural  
 Finishing: Without finish / Stainles Steel / Natural aluminium (Standard)  
 Length: 110mm

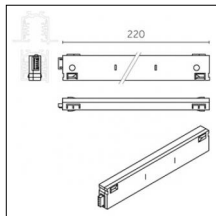

### Code 0.26501.0000 - Standard spacer - 220mm

Type: Structural  
 Finishing: Without finish / Stainles Steel / Natural aluminium (Standard)  
 Length: 220mm

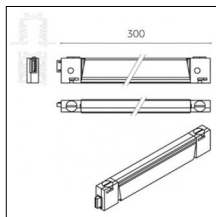

### Code 0.26502.0000 - Customizable spacer - 300mm

Type: Structural  
 Finishing: Without finish / Stainles Steel / Natural aluminium (Standard)  
 Length: 300mm

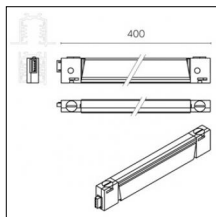

### Code 0.26503.0000 - Customizable spacer - 400mm

Type: Structural  
 Finishing: Without finish / Stainles Steel / Natural aluminium (Standard)  
 Length: 400mm

## Accessories

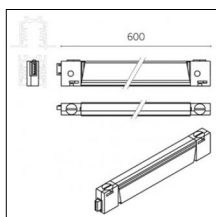

### Code 0.26504.0000 - Customizable spacer - 600mm

Type: Structural  
 Finishing: Without finish / Stainles Steel / Natural aluminium (Standard)  
 Length: 600mm

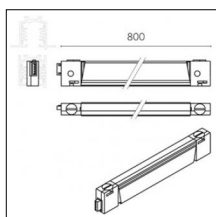

### Code 0.26505.0000 - Customizable spacer - 800mm

Type: Structural  
 Finishing: Without finish / Stainles Steel / Natural aluminium (Standard)  
 Length: 800mm

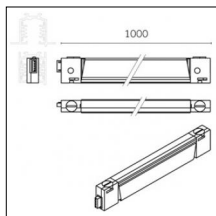

### Code 0.26506.0000 - Customizable spacer - 1000mm

Type: Structural  
 Finishing: Without finish / Stainles Steel / Natural aluminium (Standard)  
 Length: 1000mm

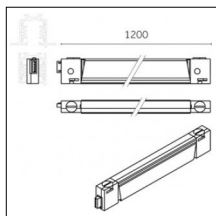

### Code 0.26507.0000 - Customizable spacer - 1200mm

Type: Structural  
 Finishing: Without finish / Stainles Steel / Natural aluminium (Standard)  
 Length: 1200mm

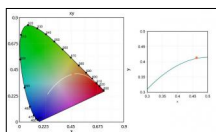

### Code 0.26701.0000 - Selective filter 3000K-2700K

Type: Optical  
 Finishing: Without finish / Stainles Steel / Natural aluminium (Standard)

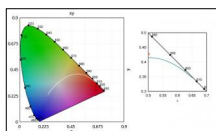

### Code 0.26702.0000 - Selective filter 2700K - 2500K

Type: Optical  
 Finishing: Without finish / Stainles Steel / Natural aluminium (Standard)

Luminaire constructed in conformity with Directives 2014/35/EU (LV), 2014/30/EU (EMC), 2009/125/EC (Ecodesign) with Regulations (EC) No 245/2009, (EU) No 347/2010 and (EU) 2015/1428 (for luminaires with fluorescent and metal halide lamps only), 2009/125/EC (Ecodesign) with Regulations (EU) No 1194/2012 and 2015/1428 (for LED luminaires only), 2011/65/EU (RoHS 2) and 2012/19/EU (WEEE).



## Accessories

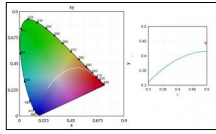
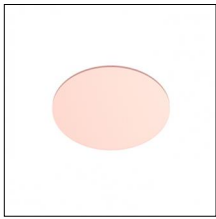

**Code 0.26703.0000 - Selective filter 2700K - 2200K**

Type: Optical

Finishing: Without finish / Stainles Steel / Natural aluminium (Standard)

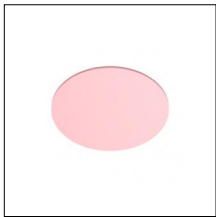

**Code 0.26704.0000 - Selective filter 2700K - 2000K**

Type: Optical

Finishing: Without finish / Stainles Steel / Natural aluminium (Standard)

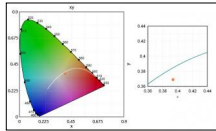
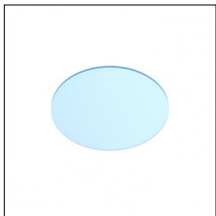

**Code 0.26705.0000 - Selective filter 3000K-3600K**

Type: Optical

Finishing: Without finish / Stainles Steel / Natural aluminium (Standard)

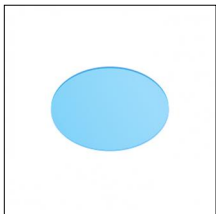

**Code 0.26706.0000 - Selective filter 3000K-4000K**

Type: Optical

Finishing: Without finish / Stainles Steel / Natural aluminium (Standard)

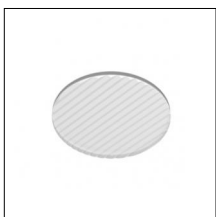

**Code 0.26707.0000 - Elliptical beam lens**

Type: Optical

Finishing: Without finish / Stainles Steel / Natural aluminium (Standard)

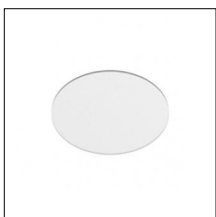

**Code 0.26708.0000 - Opal lens**

Type: Optical

Finishing: Without finish / Stainles Steel / Natural aluminium (Standard)

## Accessories

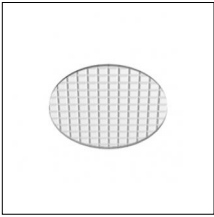

### Code 0.26709.0000 - Diffusive lens

Type: Optical

Finishing: Without finish / Stainles Steel / Natural aluminium (Standard)

---

Indoor | Pendants | Yori Pendant Ghostrack Ø22mm

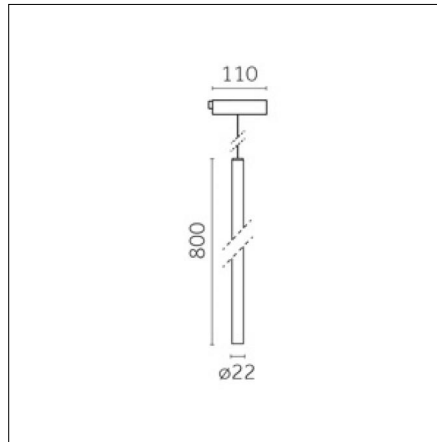
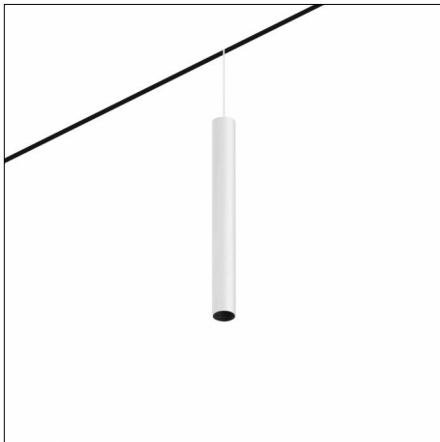

Very narrow 10°



IP20



Risk 1

850°



**Code X.CM70B.HQC0**

### Light source features

**Number of light sources:** 1

**Source type:** LED HQ

**Watt:** 2W

**Lm:** 145lm

**Lm/W:** 73lm/W

**Kelvin/CRI:** 3000K / >90

**SDCM/L90 B10:** < 3 / 50000

### Electrical features

**Driver included:** NO

**Driver position:** remote

**Driver type:** no driver included

**Isolation class:** Class III

### Optical features

**Beam angle:** 10°

**Optical type, adjustability:** Fixed

**Interchangeable optic (IOS):** NO

### Physical features

**Material:** Die-cast aluminum

**Mounting:** Track, Suspension

**Finishing:** Royal matt white

**Weight:** 0.6Kg

### Notes:

Cable length 3m

Luminaire constructed in conformity with Directives 2014/35/EU (LV), 2014/30/EU (EMC), 2009/125/EC (Ecodesign) with Regulations (EC) No 245/2009, (EU) No 347/2010 and (EU) 2015/1428 (for luminaires with fluorescent and metal halide lamps only), 2009/125/EC (Ecodesign) with Regulations (EU) No 1194/2012 and 2015/1428 (for LED luminaires only), 2011/65/EU (RoHS 2) and 2012/19/EU (WEEE).

### Reggiani SPA Illuminazione

Viale Monza, 16 20845 Sovico (MB) Italy  
Tel. (+39) 039 2071.1 fax (+39) 039 2071 999

www.reggiani.net  
contact@reggiani.net

## Photometries



Luminaire constructed in conformity with Directives 2014/35/EU (LV), 2014/30/EU (EMC), 2009/125/EC (Ecodesign) with Regulations (EC) No 245/2009, (EU) No 347/2010 and (EU) 2015/1428 (for luminaires with fluorescent and metal halide lamps only), 2009/125/EC (Ecodesign) with Regulations (EU) No 1194/2012 and 2015/1428 (for LED luminaires only), 2011/65/EU (RoHS 2) and 2012/19/EU (WEEE).

## Tracks/channels

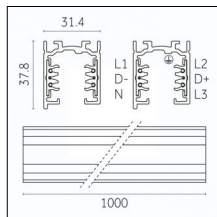
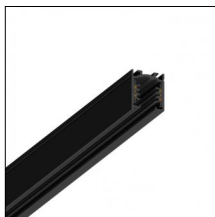

**Code 0.02030.0010 - 3-circuit track surface/pendant**

Finishing: White (Standard)  
Length: 1000mm Width: 31.4mm Height: 37.8mm

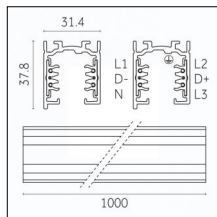

**Code 0.02030.0021 - 3-circuit track surface/pendant**

Finishing: Black (Standard)  
Length: 1000mm Width: 31.4mm Height: 37.8mm

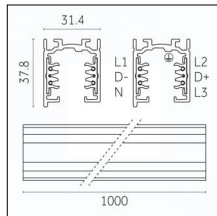
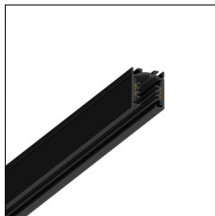

**Code 0.02030.0028 - 3-circuit track surface/pendant**

Finishing: Metallised grey (Standard)  
Length: 1000mm Width: 31.4mm Height: 37.8mm

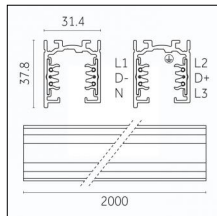

**Code 0.02031.0010 - 3-circuit track surface/pendant**

Finishing: White (Standard)  
Length: 2000mm Width: 31.4mm Height: 37.8mm

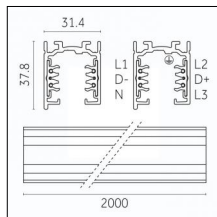

**Code 0.02031.0021 - 3-circuit track surface/pendant**

Finishing: Black (Standard)  
Length: 2000mm Width: 31.4mm Height: 37.8mm

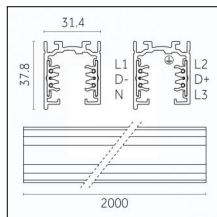

**Code 0.02031.0028 - 3-circuit track surface/pendant**

Finishing: Metallised grey (Standard)  
Length: 2000mm Width: 31.4mm Height: 37.8mm

Luminaire constructed in conformity with Directives 2014/35/EU (LV), 2014/30/EU (EMC), 2009/125/EC (Ecodesign) with Regulations (EC) No 245/2009, (EU) No 347/2010 and (EU) 2015/1428 (for luminaires with fluorescent and metal halide lamps only), 2009/125/EC (Ecodesign) with Regulations (EU) No 1194/2012 and 2015/1428 (for LED luminaires only), 2011/65/EU (RoHS 2) and 2012/19/EU (WEEE).

## Tracks/channels

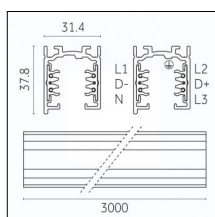
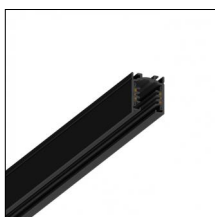

### Code 0.02032.0010 - 3-circuit track surface/pendant

Finishing: White (Standard)  
Length: 3000mm Width: 31.4mm Height: 37.8mm

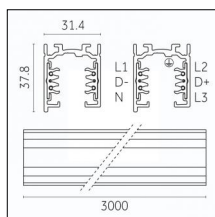
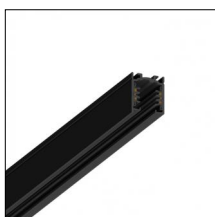

### Code 0.02032.0021 - 3-circuit track surface/pendant

Finishing: Black (Standard)  
Length: 3000mm Width: 31.4mm Height: 37.8mm

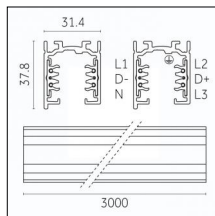
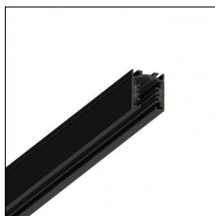

### Code 0.02032.0028 - 3-circuit track surface/pendant

Finishing: Metallised grey (Standard)  
Length: 3000mm Width: 31.4mm Height: 37.8mm

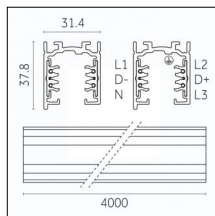
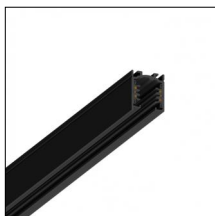

### Code 0.02033.0010 - 3-circuit track surface/pendant

Finishing: White (Standard)  
Length: 4000mm Width: 31.4mm Height: 37.8mm

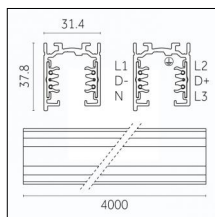

### Code 0.02033.0021 - 3-circuit track surface/pendant

Finishing: Black (Standard)  
Length: 4000mm Width: 31.4mm Height: 37.8mm

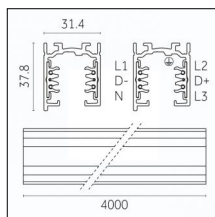
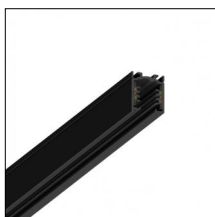

### Code 0.02033.0028 - 3-circuit track surface/pendant

Finishing: Metallised grey (Standard)  
Length: 4000mm Width: 31.4mm Height: 37.8mm

Luminaire constructed in conformity with Directives 2014/35/EU (LV), 2014/30/EU (EMC), 2009/125/EC (Ecodesign) with Regulations (EC) No 245/2009, (EU) No 347/2010 and (EU) 2015/1428 (for luminaires with fluorescent and metal halide lamps only), 2009/125/EC (Ecodesign) with Regulations (EU) No 1194/2012 and 2015/1428 (for LED luminaires only), 2011/65/EU (RoHS 2) and 2012/19/EU (WEEE).

## Tracks/channels

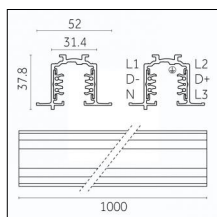

**Code 0.02034.0010 - 3-circuit track recessed**

Finishing: White (Standard)  
Length: 1000mm Width: 52mm Height: 37.8mm

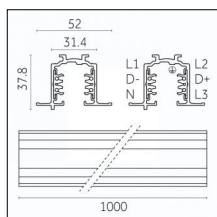

**Code 0.02034.0021 - 3-circuit track recessed**

Finishing: Black (Standard)  
Length: 1000mm Width: 52mm Height: 37.8mm

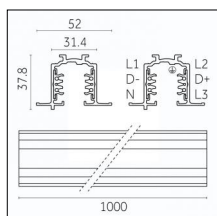

**Code 0.02034.0028 - 3-circuit track recessed**

Finishing: Metallised grey (Standard)  
Length: 1000mm Width: 52mm Height: 37.8mm

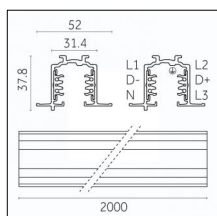

**Code 0.02035.0010 - 3-circuit track recessed**

Finishing: White (Standard)  
Length: 2000mm Width: 52mm Height: 37.8mm

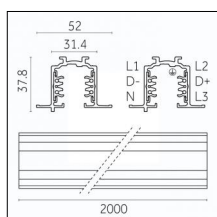

**Code 0.02035.0021 - 3-circuit track recessed**

Finishing: Black (Standard)  
Length: 2000mm Width: 52mm Height: 37.8mm

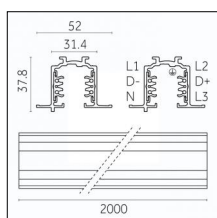

**Code 0.02035.0028 - 3-circuit track recessed**

Finishing: Metallised grey (Standard)  
Length: 2000mm Width: 52mm Height: 37.8mm

Luminaire constructed in conformity with Directives 2014/35/EU (LV), 2014/30/EU (EMC), 2009/125/EC (Ecodesign) with Regulations (EC) No 245/2009, (EU) No 347/2010 and (EU) 2015/1428 (for luminaires with fluorescent and metal halide lamps only), 2009/125/EC (Ecodesign) with Regulations (EU) No 1194/2012 and 2015/1428 (for LED luminaires only), 2011/65/EU (RoHS 2) and 2012/19/EU (WEEE).

## Tracks/channels

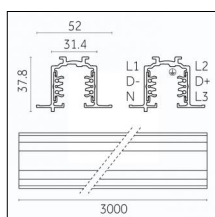

### Code 0.02036.0010 - 3-circuit track recessed

Finishing: White (Standard)  
Length: 3000mm Width: 52mm Height: 37.8mm

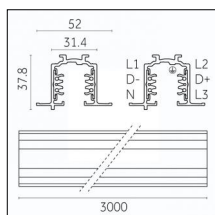

### Code 0.02036.0021 - 3-circuit track recessed

Finishing: Black (Standard)  
Length: 3000mm Width: 52mm Height: 37.8mm

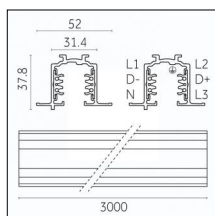

### Code 0.02036.0028 - 3-circuit track recessed

Finishing: Metallised grey (Standard)  
Length: 3000mm Width: 52mm Height: 37.8mm

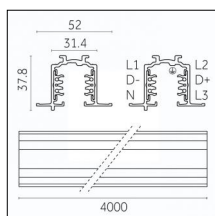
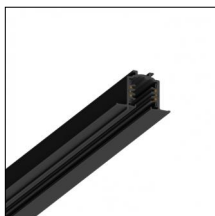

### Code 0.02037.0010 - 3-circuit track recessed

Finishing: White (Standard)  
Length: 4000mm Width: 52mm Height: 37.8mm

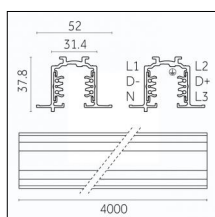

### Code 0.02037.0021 - 3-circuit track recessed

Finishing: Black (Standard)  
Length: 4000mm Width: 52mm Height: 37.8mm

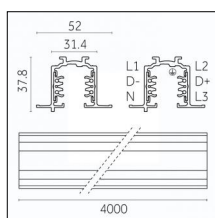

### Code 0.02037.0028 - 3-circuit track recessed

Finishing: Metallised grey (Standard)  
Length: 4000mm Width: 52mm Height: 37.8mm



## Tracks/channels

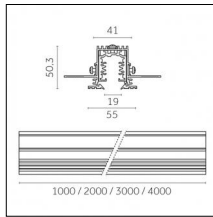

### Code 0.27101.0021 - 3-circuit track Supertrack

Finishing: Black (Standard)  
Length: 1000mm Width: 41mm Height: 50mm

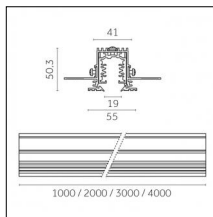

### Code 0.27102.0021 - 3-circuit track Supertrack

Finishing: Black (Standard)  
Length: 2000mm Width: 41mm Height: 50mm

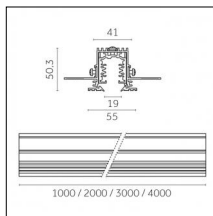

### Code 0.27103.0021 - 3-circuit track Supertrack

Finishing: Black (Standard)  
Length: 3000mm Width: 41mm Height: 50mm

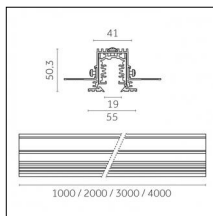

### Code 0.27104.0021 - 3-circuit track Supertrack

Finishing: Black (Standard)  
Length: 4000mm Width: 41mm Height: 50mm

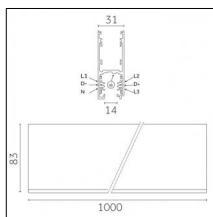
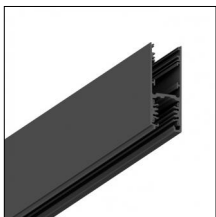

### Code 0.02505.0010 - H Track | Surface/Pendant

Finishing: White (Standard)  
Length: 1000mm Width: 31mm Height: 83mm

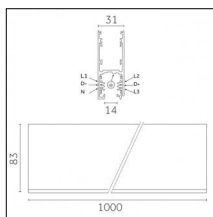
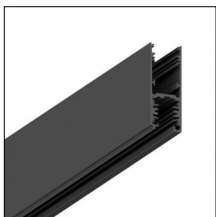

### Code 0.02505.0021 - H Track | Surface/Pendant

Finishing: Black (Standard)  
Length: 1000mm Width: 31mm Height: 83mm

Luminaire constructed in conformity with Directives 2014/35/EU (LV), 2014/30/EU (EMC), 2009/125/EC (Ecodesign) with Regulations (EC) No 245/2009, (EU) No 347/2010 and (EU) 2015/1428 (for luminaires with fluorescent and metal halide lamps only), 2009/125/EC (Ecodesign) with Regulations (EU) No 1194/2012 and 2015/1428 (for LED luminaires only), 2011/65/EU (RoHS 2) and 2012/19/EU (WEEE).

## Tracks/channels

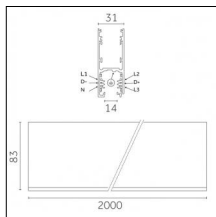

### Code 0.02506.0010 - H Track | Surface/Pendant

Finishing: White (Standard)  
Length: 2000mm Width: 31mm Height: 83mm

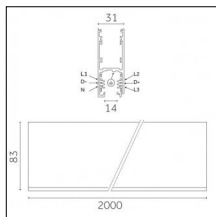

### Code 0.02506.0021 - H Track | Surface/Pendant

Finishing: Black (Standard)  
Length: 2000mm Width: 31mm Height: 83mm

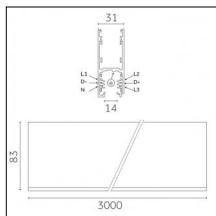

### Code 0.02507.0010 - H Track | Surface/Pendant

Finishing: White (Standard)  
Length: 3000mm Width: 31mm Height: 83mm

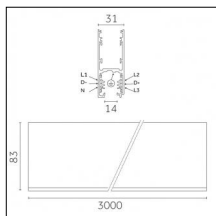

### Code 0.02507.0021 - H Track | Surface/Pendant

Finishing: Black (Standard)  
Length: 3000mm Width: 31mm Height: 83mm

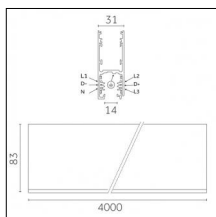

### Code 0.02508.0010 - H Track | Surface/Pendant

Finishing: White (Standard)  
Length: 4000mm Width: 31mm Height: 83mm

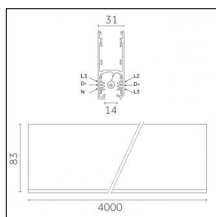
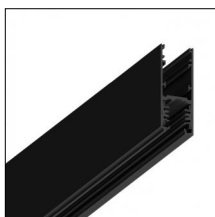

### Code 0.02508.0021 - H Track | Surface/Pendant

Finishing: Black (Standard)  
Length: 4000mm Width: 31mm Height: 83mm

Luminaire constructed in conformity with Directives 2014/35/EU (LV), 2014/30/EU (EMC), 2009/125/EC (Ecodesign) with Regulations (EC) No 245/2009, (EU) No 347/2010 and (EU) 2015/1428 (for luminaires with fluorescent and metal halide lamps only), 2009/125/EC (Ecodesign) with Regulations (EU) No 1194/2012 and 2015/1428 (for LED luminaires only), 2011/65/EU (RoHS 2) and 2012/19/EU (WEEE).

## Driver

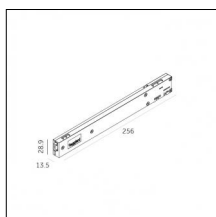

### Code 0.30457.0000 - Driver

Type: On-Off

Watt: 35W - AC Input: 220-240Vac - mA:700mA

Description: Connection options:

1X: 9-15pz

2X: 3-5pz

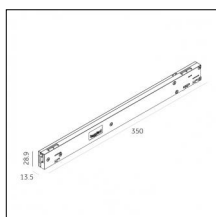

### Code D.30457.0000 - Driver

Type: DALI

Watt: 35W - AC Input: 120-277Vac - mA:700mA

Description: Connection options:

1X: 3-15pz

2X: 1-5pz

## Accessories

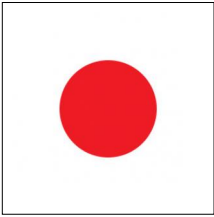

**Code 0.26700.004A - Red glass filter 1 mm**

Type: Optical  
Finishing: Red

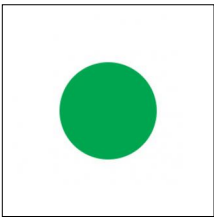

**Code 0.26700.005A - Green glass filter 1 mm**

Type: Optical  
Finishing: Green

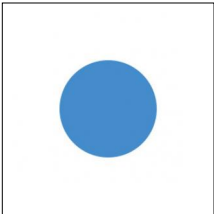

**Code 0.26700.006A - Blue glass filter 1 mm**

Type: Optical  
Finishing: Blue

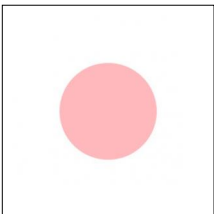

**Code 0.26700.007A - Pink glass filter 1 mm**

Type: Optical  
Finishing: Pink

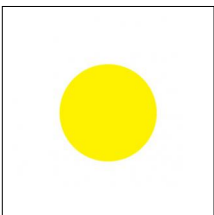

**Code 0.26700.008A - Yellow glass filter 1 mm**

Type: Optical  
Finishing: Yellow

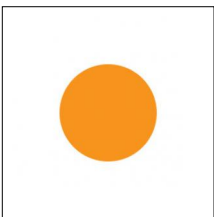

**Code 0.26700.009A - Orange glass filter 1 mm**

Type: Optical  
Finishing: Orange

## Accessories

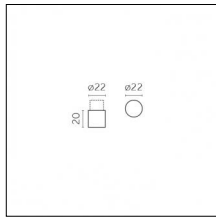

### Code 0.26040.0000 - Cylinder, Full version

Type: Optical  
 Finishing: Without finish / Stainles Steel / Natural aluminium (Standard)  
 Height: 22mm  
 Description: Full version

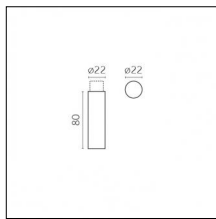
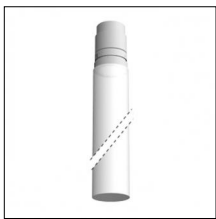

### Code 0.26041.0000 - Cylinder, Full version

Type: Optical  
 Finishing: Without finish / Stainles Steel / Natural aluminium (Standard)  
 Height: 80mm  
 Description: Full version

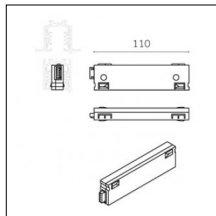

### Code 0.26500.0000 - Standard spacer - 110mm

Type: Structural  
 Finishing: Without finish / Stainles Steel / Natural aluminium (Standard)  
 Length: 110mm

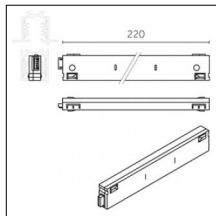

### Code 0.26501.0000 - Standard spacer - 220mm

Type: Structural  
 Finishing: Without finish / Stainles Steel / Natural aluminium (Standard)  
 Length: 220mm

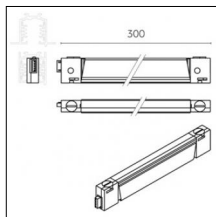

### Code 0.26502.0000 - Customizable spacer - 300mm

Type: Structural  
 Finishing: Without finish / Stainles Steel / Natural aluminium (Standard)  
 Length: 300mm

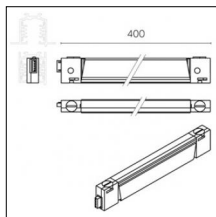

### Code 0.26503.0000 - Customizable spacer - 400mm

Type: Structural  
 Finishing: Without finish / Stainles Steel / Natural aluminium (Standard)  
 Length: 400mm

## Accessories

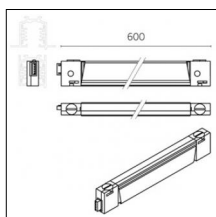

### Code 0.26504.0000 - Customizable spacer - 600mm

Type: Structural  
 Finishing: Without finish / Stainles Steel / Natural aluminium (Standard)  
 Length: 600mm

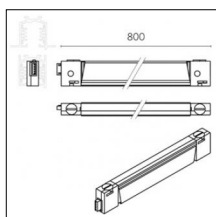

### Code 0.26505.0000 - Customizable spacer - 800mm

Type: Structural  
 Finishing: Without finish / Stainles Steel / Natural aluminium (Standard)  
 Length: 800mm

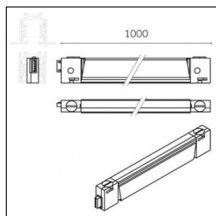

### Code 0.26506.0000 - Customizable spacer - 1000mm

Type: Structural  
 Finishing: Without finish / Stainles Steel / Natural aluminium (Standard)  
 Length: 1000mm

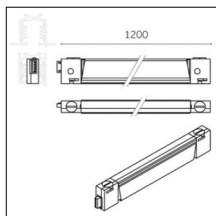

### Code 0.26507.0000 - Customizable spacer - 1200mm

Type: Structural  
 Finishing: Without finish / Stainles Steel / Natural aluminium (Standard)  
 Length: 1200mm

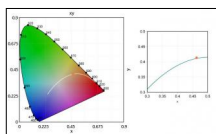

### Code 0.26701.0000 - Selective filter 3000K-2700K

Type: Optical  
 Finishing: Without finish / Stainles Steel / Natural aluminium (Standard)

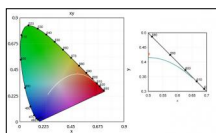
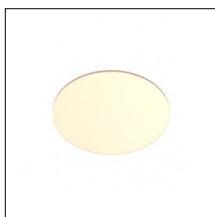

### Code 0.26702.0000 - Selective filter 2700K - 2500K

Type: Optical  
 Finishing: Without finish / Stainles Steel / Natural aluminium (Standard)

Luminaire constructed in conformity with Directives 2014/35/EU (LV), 2014/30/EU (EMC), 2009/125/EC (Ecodesign) with Regulations (EC) No 245/2009, (EU) No 347/2010 and (EU) 2015/1428 (for luminaires with fluorescent and metal halide lamps only), 2009/125/EC (Ecodesign) with Regulations (EU) No 1194/2012 and 2015/1428 (for LED luminaires only), 2011/65/EU (RoHS 2) and 2012/19/EU (WEEE).

## Accessories

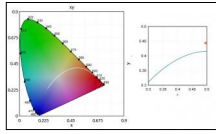
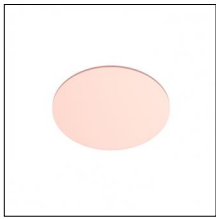

**Code 0.26703.0000 - Selective filter 2700K - 2200K**

Type: Optical

Finishing: Without finish / Stainles Steel / Natural aluminium (Standard)

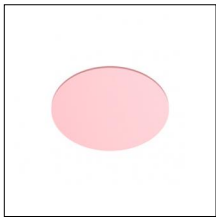

**Code 0.26704.0000 - Selective filter 2700K - 2000K**

Type: Optical

Finishing: Without finish / Stainles Steel / Natural aluminium (Standard)

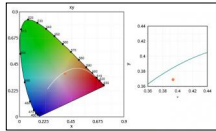
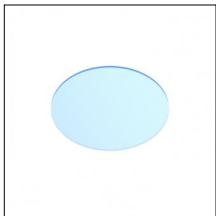

**Code 0.26705.0000 - Selective filter 3000K-3600K**

Type: Optical

Finishing: Without finish / Stainles Steel / Natural aluminium (Standard)

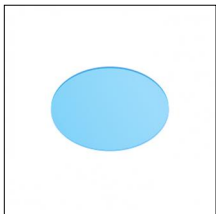

**Code 0.26706.0000 - Selective filter 3000K-4000K**

Type: Optical

Finishing: Without finish / Stainles Steel / Natural aluminium (Standard)

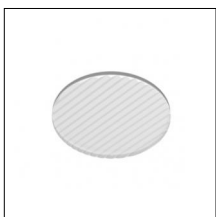

**Code 0.26707.0000 - Elliptical beam lens**

Type: Optical

Finishing: Without finish / Stainles Steel / Natural aluminium (Standard)

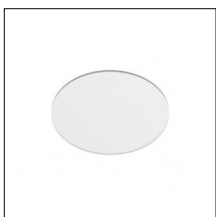

**Code 0.26708.0000 - Opal lens**

Type: Optical

Finishing: Without finish / Stainles Steel / Natural aluminium (Standard)

## Accessories

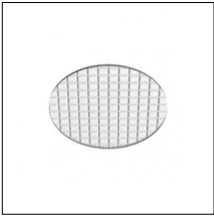

**Code 0.26709.0000 - Diffusive lens**

Type: Optical

Finishing: Without finish / Stainles Steel / Natural aluminium (Standard)

---



Indoor | Pendants | Yori Pendant Ghostrack Ø22mm

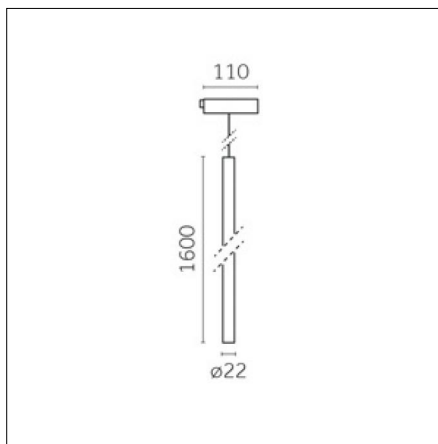
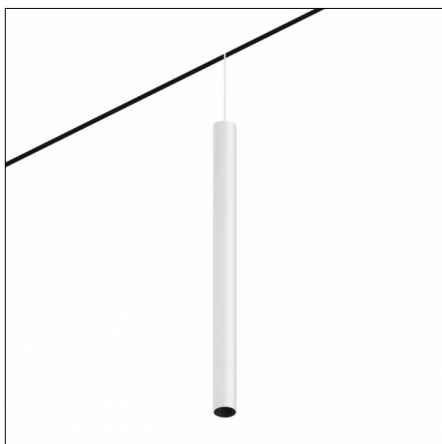

Very narrow 10°



IP20



Risk 1

850°



**Code X.DM70B.HQE0**

### Light source features

**Number of light sources:** 1

**Source type:** LED HQ

**Watt:** 2W

**Lm:** 145lm

**Lm/W:** 73lm/W

**Kelvin/CRI:** 3000K / >90

**SDCM/L90 B10:** < 3 / 50000

### Electrical features

**Driver included:** NO

**Driver position:** remote

**Driver type:** no driver included

**Isolation class:** Class III

### Optical features

**Beam angle:** 10°

**Optical type, adjustability:** Fixed

**Interchangeable optic (IOS):** NO

### Physical features

**Material:** Die-cast aluminum

**Mounting:** Track, Suspension

**Finishing:** Brushed gold

**Weight:** 1.2Kg

### Notes:

Cable length 3m

Luminaire constructed in conformity with Directives 2014/35/EU (LV), 2014/30/EU (EMC), 2009/125/EC (Ecodesign) with Regulations (EC) No 245/2009, (EU) No 347/2010 and (EU) 2015/1428 (for luminaires with fluorescent and metal halide lamps only), 2009/125/EC (Ecodesign) with Regulations (EU) No 1194/2012 and 2015/1428 (for LED luminaires only), 2011/65/EU (RoHS 2) and 2012/19/EU (WEEE).

### Reggiani SPA Illuminazione

Viale Monza, 16 20845 Sovico (MB) Italy  
Tel. (+39) 039 2071.1 fax (+39) 039 2071 999

www.reggiani.net  
contact@reggiani.net

## Photometries



## Tracks/channels

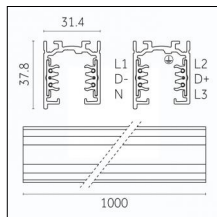
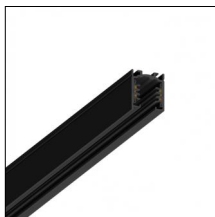

**Code 0.02030.0010 - 3-circuit track surface/pendant**

Finishing: White (Standard)  
Length: 1000mm Width: 31.4mm Height: 37.8mm

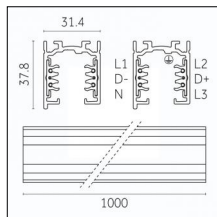

**Code 0.02030.0021 - 3-circuit track surface/pendant**

Finishing: Black (Standard)  
Length: 1000mm Width: 31.4mm Height: 37.8mm

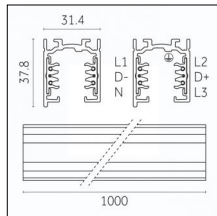

**Code 0.02030.0028 - 3-circuit track surface/pendant**

Finishing: Metallised grey (Standard)  
Length: 1000mm Width: 31.4mm Height: 37.8mm

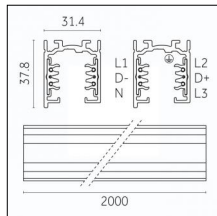

**Code 0.02031.0010 - 3-circuit track surface/pendant**

Finishing: White (Standard)  
Length: 2000mm Width: 31.4mm Height: 37.8mm

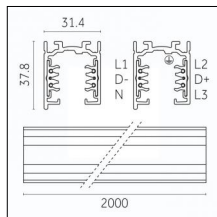
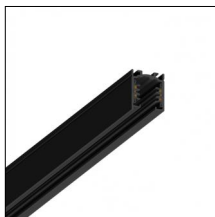

**Code 0.02031.0021 - 3-circuit track surface/pendant**

Finishing: Black (Standard)  
Length: 2000mm Width: 31.4mm Height: 37.8mm

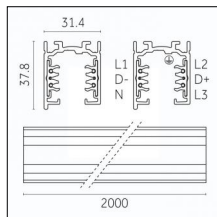

**Code 0.02031.0028 - 3-circuit track surface/pendant**

Finishing: Metallised grey (Standard)  
Length: 2000mm Width: 31.4mm Height: 37.8mm

## Tracks/channels

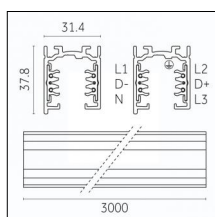

### Code 0.02032.0010 - 3-circuit track surface/pendant

Finishing: White (Standard)  
Length: 3000mm Width: 31.4mm Height: 37.8mm

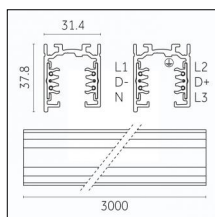
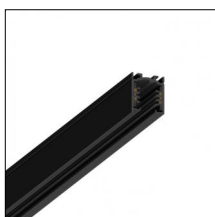

### Code 0.02032.0021 - 3-circuit track surface/pendant

Finishing: Black (Standard)  
Length: 3000mm Width: 31.4mm Height: 37.8mm

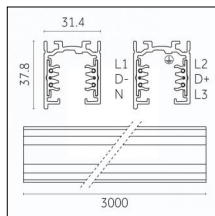
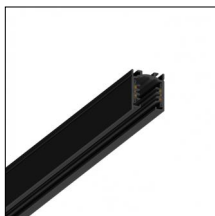

### Code 0.02032.0028 - 3-circuit track surface/pendant

Finishing: Metallised grey (Standard)  
Length: 3000mm Width: 31.4mm Height: 37.8mm

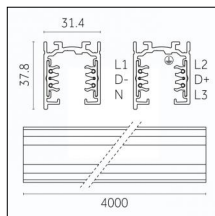
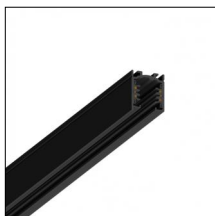

### Code 0.02033.0010 - 3-circuit track surface/pendant

Finishing: White (Standard)  
Length: 4000mm Width: 31.4mm Height: 37.8mm

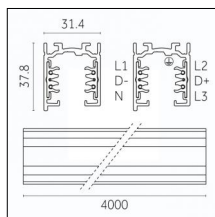

### Code 0.02033.0021 - 3-circuit track surface/pendant

Finishing: Black (Standard)  
Length: 4000mm Width: 31.4mm Height: 37.8mm

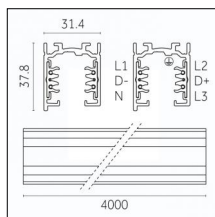

### Code 0.02033.0028 - 3-circuit track surface/pendant

Finishing: Metallised grey (Standard)  
Length: 4000mm Width: 31.4mm Height: 37.8mm

Luminaire constructed in conformity with Directives 2014/35/EU (LV), 2014/30/EU (EMC), 2009/125/EC (Ecodesign) with Regulations (EC) No 245/2009, (EU) No 347/2010 and (EU) 2015/1428 (for luminaires with fluorescent and metal halide lamps only), 2009/125/EC (Ecodesign) with Regulations (EU) No 1194/2012 and 2015/1428 (for LED luminaires only), 2011/65/EU (RoHS 2) and 2012/19/EU (WEEE).

## Tracks/channels

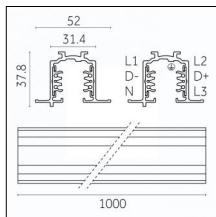

**Code 0.02034.0010 - 3-circuit track recessed**

Finishing: White (Standard)  
Length: 1000mm Width: 52mm Height: 37.8mm

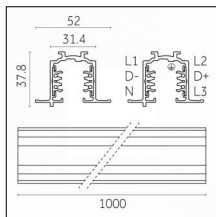

**Code 0.02034.0021 - 3-circuit track recessed**

Finishing: Black (Standard)  
Length: 1000mm Width: 52mm Height: 37.8mm

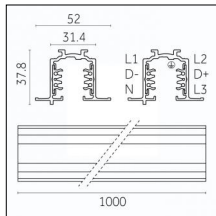

**Code 0.02034.0028 - 3-circuit track recessed**

Finishing: Metallised grey (Standard)  
Length: 1000mm Width: 52mm Height: 37.8mm

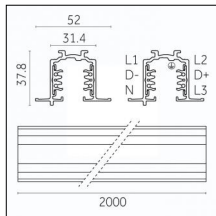

**Code 0.02035.0010 - 3-circuit track recessed**

Finishing: White (Standard)  
Length: 2000mm Width: 52mm Height: 37.8mm

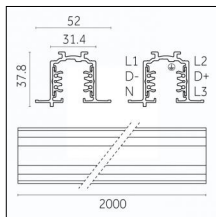

**Code 0.02035.0021 - 3-circuit track recessed**

Finishing: Black (Standard)  
Length: 2000mm Width: 52mm Height: 37.8mm

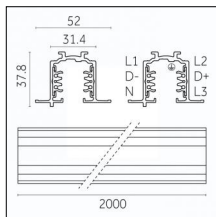

**Code 0.02035.0028 - 3-circuit track recessed**

Finishing: Metallised grey (Standard)  
Length: 2000mm Width: 52mm Height: 37.8mm

## Tracks/channels

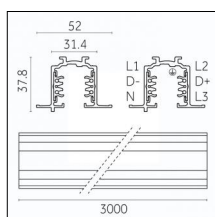

### Code 0.02036.0010 - 3-circuit track recessed

Finishing: White (Standard)  
Length: 3000mm Width: 52mm Height: 37.8mm

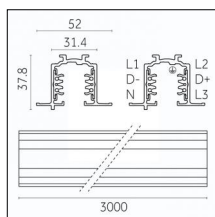

### Code 0.02036.0021 - 3-circuit track recessed

Finishing: Black (Standard)  
Length: 3000mm Width: 52mm Height: 37.8mm

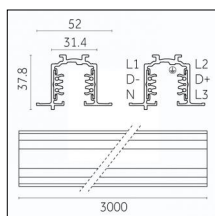

### Code 0.02036.0028 - 3-circuit track recessed

Finishing: Metallised grey (Standard)  
Length: 3000mm Width: 52mm Height: 37.8mm

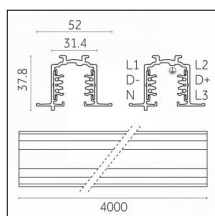
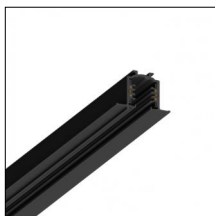

### Code 0.02037.0010 - 3-circuit track recessed

Finishing: White (Standard)  
Length: 4000mm Width: 52mm Height: 37.8mm

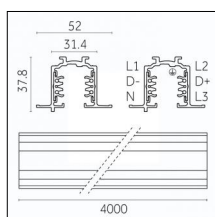

### Code 0.02037.0021 - 3-circuit track recessed

Finishing: Black (Standard)  
Length: 4000mm Width: 52mm Height: 37.8mm

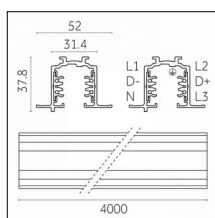

### Code 0.02037.0028 - 3-circuit track recessed

Finishing: Metallised grey (Standard)  
Length: 4000mm Width: 52mm Height: 37.8mm

Luminaire constructed in conformity with Directives 2014/35/EU (LV), 2014/30/EU (EMC), 2009/125/EC (Ecodesign) with Regulations (EC) No 245/2009, (EU) No 347/2010 and (EU) 2015/1428 (for luminaires with fluorescent and metal halide lamps only), 2009/125/EC (Ecodesign) with Regulations (EU) No 1194/2012 and 2015/1428 (for LED luminaires only), 2011/65/EU (RoHS 2) and 2012/19/EU (WEEE).

## Tracks/channels

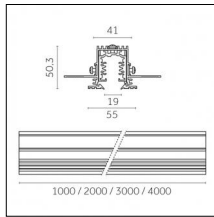

### Code 0.27101.0021 - 3-circuit track Supertrack

Finishing: Black (Standard)  
Length: 1000mm Width: 41mm Height: 50mm

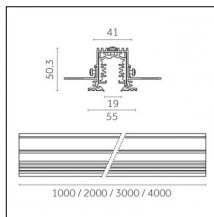

### Code 0.27102.0021 - 3-circuit track Supertrack

Finishing: Black (Standard)  
Length: 2000mm Width: 41mm Height: 50mm

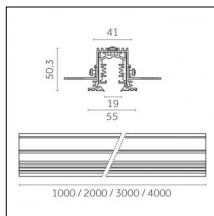

### Code 0.27103.0021 - 3-circuit track Supertrack

Finishing: Black (Standard)  
Length: 3000mm Width: 41mm Height: 50mm

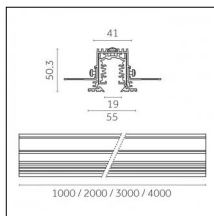

### Code 0.27104.0021 - 3-circuit track Supertrack

Finishing: Black (Standard)  
Length: 4000mm Width: 41mm Height: 50mm

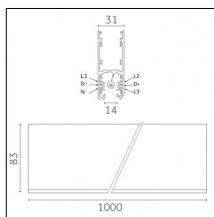
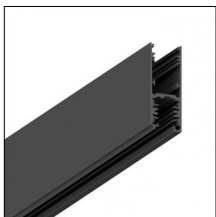

### Code 0.02505.0010 - H Track | Surface/Pendant

Finishing: White (Standard)  
Length: 1000mm Width: 31mm Height: 83mm

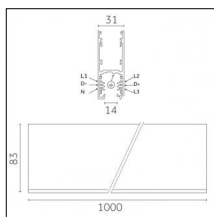
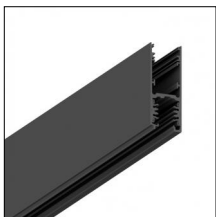

### Code 0.02505.0021 - H Track | Surface/Pendant

Finishing: Black (Standard)  
Length: 1000mm Width: 31mm Height: 83mm

Luminaire constructed in conformity with Directives 2014/35/EU (LV), 2014/30/EU (EMC), 2009/125/EC (Ecodesign) with Regulations (EC) No 245/2009, (EU) No 347/2010 and (EU) 2015/1428 (for luminaires with fluorescent and metal halide lamps only), 2009/125/EC (Ecodesign) with Regulations (EU) No 1194/2012 and 2015/1428 (for LED luminaires only), 2011/65/EU (RoHS 2) and 2012/19/EU (WEEE).

## Tracks/channels

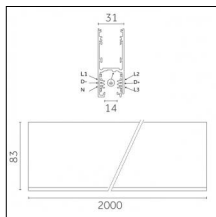

### Code 0.02506.0010 - H Track | Surface/Pendant

Finishing: White (Standard)  
Length: 2000mm Width: 31mm Height: 83mm

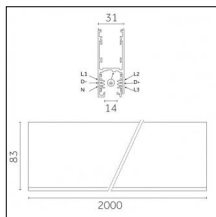

### Code 0.02506.0021 - H Track | Surface/Pendant

Finishing: Black (Standard)  
Length: 2000mm Width: 31mm Height: 83mm

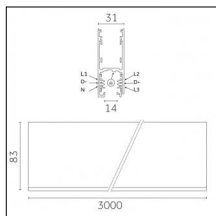

### Code 0.02507.0010 - H Track | Surface/Pendant

Finishing: White (Standard)  
Length: 3000mm Width: 31mm Height: 83mm

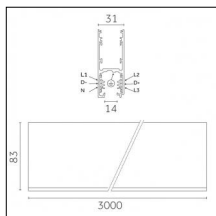
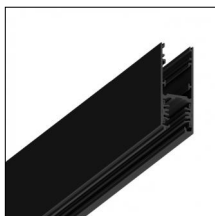

### Code 0.02507.0021 - H Track | Surface/Pendant

Finishing: Black (Standard)  
Length: 3000mm Width: 31mm Height: 83mm

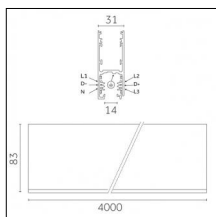

### Code 0.02508.0010 - H Track | Surface/Pendant

Finishing: White (Standard)  
Length: 4000mm Width: 31mm Height: 83mm

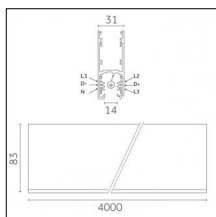

### Code 0.02508.0021 - H Track | Surface/Pendant

Finishing: Black (Standard)  
Length: 4000mm Width: 31mm Height: 83mm

Luminaire constructed in conformity with Directives 2014/35/EU (LV), 2014/30/EU (EMC), 2009/125/EC (Ecodesign) with Regulations (EC) No 245/2009, (EU) No 347/2010 and (EU) 2015/1428 (for luminaires with fluorescent and metal halide lamps only), 2009/125/EC (Ecodesign) with Regulations (EU) No 1194/2012 and 2015/1428 (for LED luminaires only), 2011/65/EU (RoHS 2) and 2012/19/EU (WEEE).



## Driver

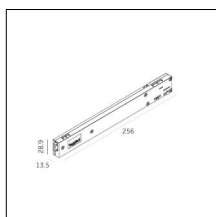

### Code 0.30457.0000 - Driver

Type: On-Off

Watt: 35W - AC Input: 220-240Vac - mA:700mA

Description: Connection options:

1X: 9-15pz

2X: 3-5pz

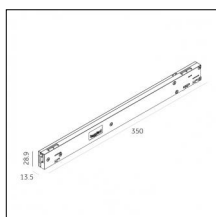

### Code D.30457.0000 - Driver

Type: DALI

Watt: 35W - AC Input: 120-277Vac - mA:700mA

Description: Connection options:

1X: 3-15pz

2X: 1-5pz

## Accessories

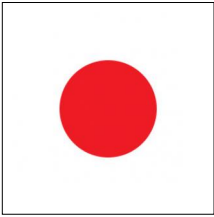

**Code 0.26700.004A - Red glass filter 1 mm**

Type: Optical  
Finishing: Red

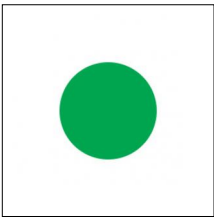

**Code 0.26700.005A - Green glass filter 1 mm**

Type: Optical  
Finishing: Green

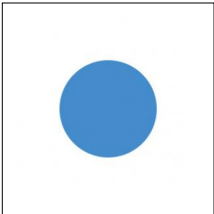

**Code 0.26700.006A - Blue glass filter 1 mm**

Type: Optical  
Finishing: Blue

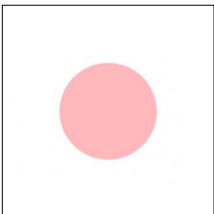

**Code 0.26700.007A - Pink glass filter 1 mm**

Type: Optical  
Finishing: Pink

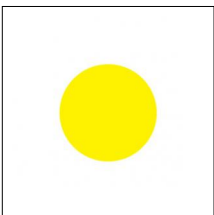

**Code 0.26700.008A - Yellow glass filter 1 mm**

Type: Optical  
Finishing: Yellow

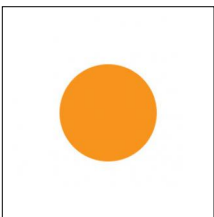

**Code 0.26700.009A - Orange glass filter 1 mm**

Type: Optical  
Finishing: Orange

## Accessories

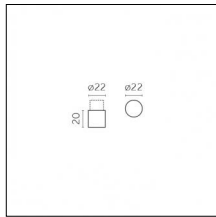

### Code 0.26040.0000 - Cylinder, Full version

Type: Optical  
 Finishing: Without finish / Stainles Steel / Natural aluminium (Standard)  
 Height: 22mm  
 Description: Full version

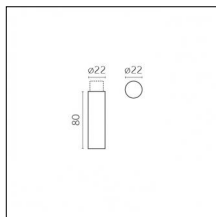
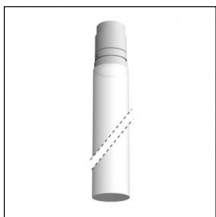

### Code 0.26041.0000 - Cylinder, Full version

Type: Optical  
 Finishing: Without finish / Stainles Steel / Natural aluminium (Standard)  
 Height: 80mm  
 Description: Full version

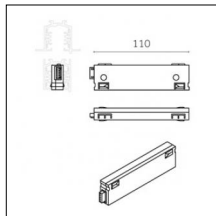

### Code 0.26500.0000 - Standard spacer - 110mm

Type: Structural  
 Finishing: Without finish / Stainles Steel / Natural aluminium (Standard)  
 Length: 110mm

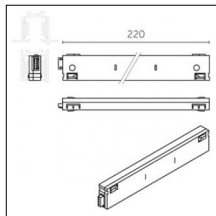

### Code 0.26501.0000 - Standard spacer - 220mm

Type: Structural  
 Finishing: Without finish / Stainles Steel / Natural aluminium (Standard)  
 Length: 220mm

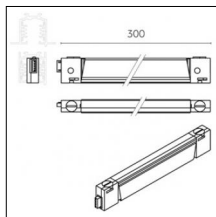

### Code 0.26502.0000 - Customizable spacer - 300mm

Type: Structural  
 Finishing: Without finish / Stainles Steel / Natural aluminium (Standard)  
 Length: 300mm

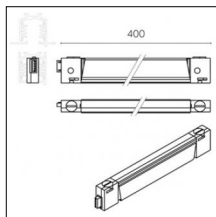

### Code 0.26503.0000 - Customizable spacer - 400mm

Type: Structural  
 Finishing: Without finish / Stainles Steel / Natural aluminium (Standard)  
 Length: 400mm

## Accessories

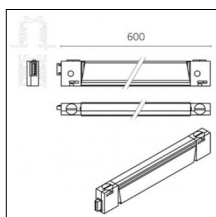

### Code 0.26504.0000 - Customizable spacer - 600mm

Type: Structural  
 Finishing: Without finish / Stainles Steel / Natural aluminium (Standard)  
 Length: 600mm

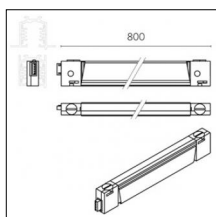

### Code 0.26505.0000 - Customizable spacer - 800mm

Type: Structural  
 Finishing: Without finish / Stainles Steel / Natural aluminium (Standard)  
 Length: 800mm

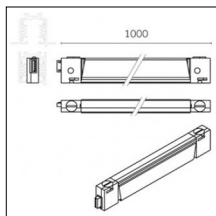

### Code 0.26506.0000 - Customizable spacer - 1000mm

Type: Structural  
 Finishing: Without finish / Stainles Steel / Natural aluminium (Standard)  
 Length: 1000mm

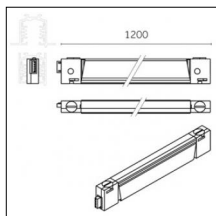

### Code 0.26507.0000 - Customizable spacer - 1200mm

Type: Structural  
 Finishing: Without finish / Stainles Steel / Natural aluminium (Standard)  
 Length: 1200mm

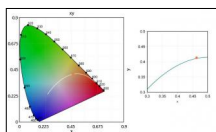

### Code 0.26701.0000 - Selective filter 3000K-2700K

Type: Optical  
 Finishing: Without finish / Stainles Steel / Natural aluminium (Standard)

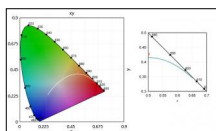

### Code 0.26702.0000 - Selective filter 2700K - 2500K

Type: Optical  
 Finishing: Without finish / Stainles Steel / Natural aluminium (Standard)

Luminaire constructed in conformity with Directives 2014/35/EU (LV), 2014/30/EU (EMC), 2009/125/EC (Ecodesign) with Regulations (EC) No 245/2009, (EU) No 347/2010 and (EU) 2015/1428 (for luminaires with fluorescent and metal halide lamps only), 2009/125/EC (Ecodesign) with Regulations (EU) No 1194/2012 and 2015/1428 (for LED luminaires only), 2011/65/EU (RoHS 2) and 2012/19/EU (WEEE).

## Accessories

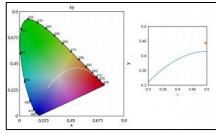
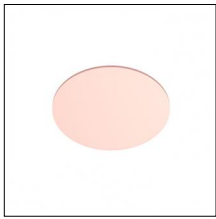

**Code 0.26703.0000 - Selective filter 2700K - 2200K**

Type: Optical

Finishing: Without finish / Stainles Steel / Natural aluminium (Standard)

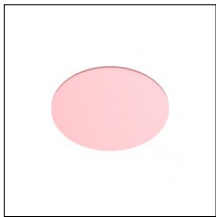

**Code 0.26704.0000 - Selective filter 2700K - 2000K**

Type: Optical

Finishing: Without finish / Stainles Steel / Natural aluminium (Standard)

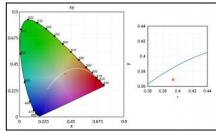
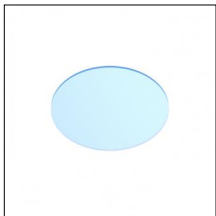

**Code 0.26705.0000 - Selective filter 3000K-3600K**

Type: Optical

Finishing: Without finish / Stainles Steel / Natural aluminium (Standard)

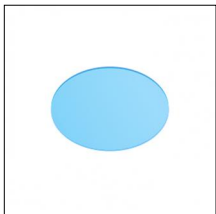

**Code 0.26706.0000 - Selective filter 3000K-4000K**

Type: Optical

Finishing: Without finish / Stainles Steel / Natural aluminium (Standard)

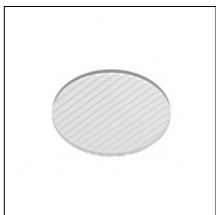

**Code 0.26707.0000 - Elliptical beam lens**

Type: Optical

Finishing: Without finish / Stainles Steel / Natural aluminium (Standard)

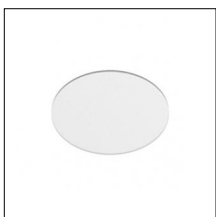

**Code 0.26708.0000 - Opal lens**

Type: Optical

Finishing: Without finish / Stainles Steel / Natural aluminium (Standard)

## Accessories

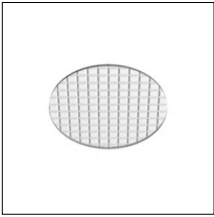

### Code 0.26709.0000 - Diffusive lens

Type: Optical

Finishing: Without finish / Stainles Steel / Natural aluminium (Standard)

---

Indoor | Pendants | Yori Pendant Ghostrack Ø35mm

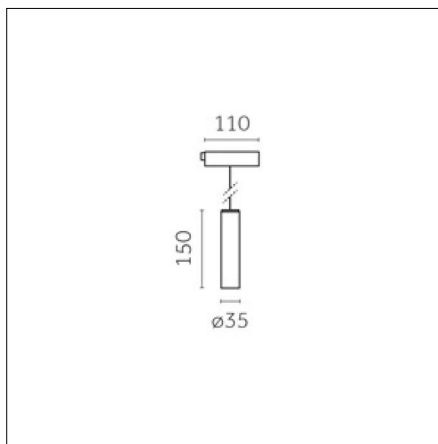

Very narrow 10°



IP20



Risk 1

850°



**Code X.FM71B.HWM0**

### Light source features

**Number of light sources:** 1

**Source type:** LED HW

**Watt:** 2.7W

**Lm:** 270lm

**Lm/W:** 100lm/W

**Kelvin/CRI:** 2700K / >90

**SDCM/L90 B10:** < 3 / 50000

### Electrical features

**Driver included:** NO

**Driver position:** remote

**Driver type:** no driver included

**Isolation class:** Class III

### Optical features

**Beam angle:** 10°

**Optical type, adjustability:** Fixed

**Interchangeable optic (IOS):** NO

### Physical features

**Material:** Die-cast aluminum

**Mounting:** Track, Suspension

**Finishing:** Brushed aluminum

### Notes:

Cable length 3m

Luminaire constructed in conformity with Directives 2014/35/EU (LV), 2014/30/EU (EMC), 2009/125/EC (Ecodesign) with Regulations (EC) No 245/2009, (EU) No 347/2010 and (EU) 2015/1428 (for luminaires with fluorescent and metal halide lamps only), 2009/125/EC (Ecodesign) with Regulations (EU) No 1194/2012 and 2015/1428 (for LED luminaires only), 2011/65/EU (RoHS 2) and 2012/19/EU (WEEE).

### Reggiani SPA Illuminazione

Viale Monza, 16 20845 Sovico (MB) Italy  
Tel. (+39) 039 2071.1 fax (+39) 039 2071 999

www.reggiani.net  
contact@reggiani.net

## Photometries





## Tracks/channels

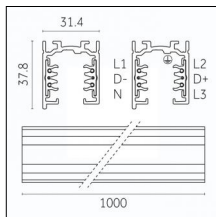

**Code 0.02030.0010 - 3-circuit track surface/pendant**

Finishing: White (Standard)  
Length: 1000mm Width: 31.4mm Height: 37.8mm

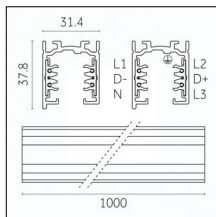

**Code 0.02030.0021 - 3-circuit track surface/pendant**

Finishing: Black (Standard)  
Length: 1000mm Width: 31.4mm Height: 37.8mm

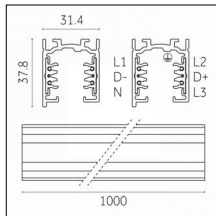

**Code 0.02030.0028 - 3-circuit track surface/pendant**

Finishing: Metallised grey (Standard)  
Length: 1000mm Width: 31.4mm Height: 37.8mm

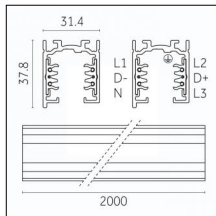

**Code 0.02031.0010 - 3-circuit track surface/pendant**

Finishing: White (Standard)  
Length: 2000mm Width: 31.4mm Height: 37.8mm

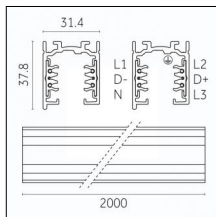

**Code 0.02031.0021 - 3-circuit track surface/pendant**

Finishing: Black (Standard)  
Length: 2000mm Width: 31.4mm Height: 37.8mm

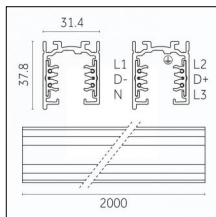

**Code 0.02031.0028 - 3-circuit track surface/pendant**

Finishing: Metallised grey (Standard)  
Length: 2000mm Width: 31.4mm Height: 37.8mm

## Tracks/channels

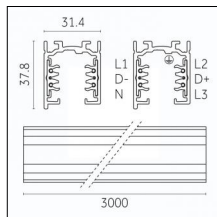

**Code 0.02032.0010 - 3-circuit track surface/pendant**

Finishing: White (Standard)  
Length: 3000mm Width: 31.4mm Height: 37.8mm

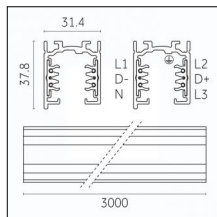
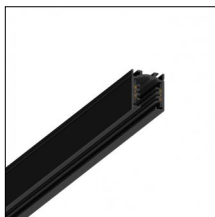

**Code 0.02032.0021 - 3-circuit track surface/pendant**

Finishing: Black (Standard)  
Length: 3000mm Width: 31.4mm Height: 37.8mm

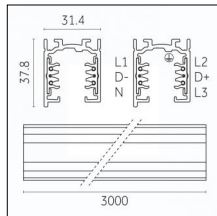

**Code 0.02032.0028 - 3-circuit track surface/pendant**

Finishing: Metallised grey (Standard)  
Length: 3000mm Width: 31.4mm Height: 37.8mm

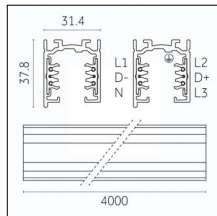

**Code 0.02033.0010 - 3-circuit track surface/pendant**

Finishing: White (Standard)  
Length: 4000mm Width: 31.4mm Height: 37.8mm

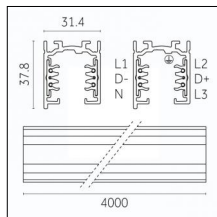

**Code 0.02033.0021 - 3-circuit track surface/pendant**

Finishing: Black (Standard)  
Length: 4000mm Width: 31.4mm Height: 37.8mm

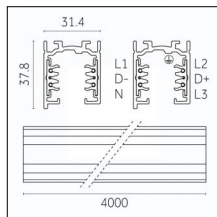
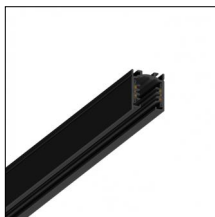

**Code 0.02033.0028 - 3-circuit track surface/pendant**

Finishing: Metallised grey (Standard)  
Length: 4000mm Width: 31.4mm Height: 37.8mm

Luminaire constructed in conformity with Directives 2014/35/EU (LV), 2014/30/EU (EMC), 2009/125/EC (Ecodesign) with Regulations (EC) No 245/2009, (EU) No 347/2010 and (EU) 2015/1428 (for luminaires with fluorescent and metal halide lamps only), 2009/125/EC (Ecodesign) with Regulations (EU) No 1194/2012 and 2015/1428 (for LED luminaires only), 2011/65/EU (RoHS 2) and 2012/19/EU (WEEE).

## Tracks/channels

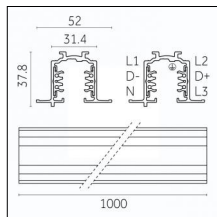

**Code 0.02034.0010 - 3-circuit track recessed**

Finishing: White (Standard)  
Length: 1000mm Width: 52mm Height: 37.8mm

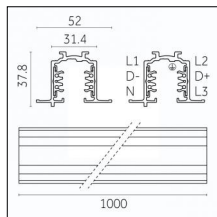

**Code 0.02034.0021 - 3-circuit track recessed**

Finishing: Black (Standard)  
Length: 1000mm Width: 52mm Height: 37.8mm

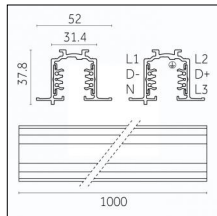

**Code 0.02034.0028 - 3-circuit track recessed**

Finishing: Metallised grey (Standard)  
Length: 1000mm Width: 52mm Height: 37.8mm

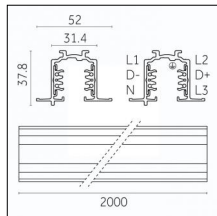

**Code 0.02035.0010 - 3-circuit track recessed**

Finishing: White (Standard)  
Length: 2000mm Width: 52mm Height: 37.8mm

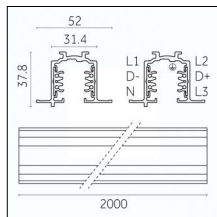

**Code 0.02035.0021 - 3-circuit track recessed**

Finishing: Black (Standard)  
Length: 2000mm Width: 52mm Height: 37.8mm

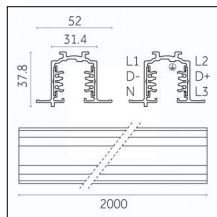

**Code 0.02035.0028 - 3-circuit track recessed**

Finishing: Metallised grey (Standard)  
Length: 2000mm Width: 52mm Height: 37.8mm

Luminaire constructed in conformity with Directives 2014/35/EU (LV), 2014/30/EU (EMC), 2009/125/EC (Ecodesign) with Regulations (EC) No 245/2009, (EU) No 347/2010 and (EU) 2015/1428 (for luminaires with fluorescent and metal halide lamps only), 2009/125/EC (Ecodesign) with Regulations (EU) No 1194/2012 and 2015/1428 (for LED luminaires only), 2011/65/EU (RoHS 2) and 2012/19/EU (WEEE).

## Tracks/channels

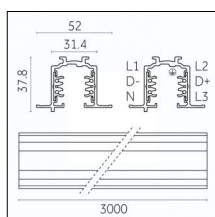
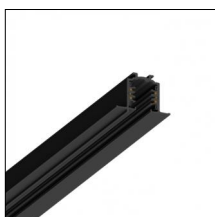

### Code 0.02036.0010 - 3-circuit track recessed

Finishing: White (Standard)  
Length: 3000mm Width: 52mm Height: 37.8mm

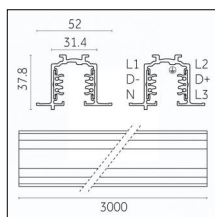

### Code 0.02036.0021 - 3-circuit track recessed

Finishing: Black (Standard)  
Length: 3000mm Width: 52mm Height: 37.8mm

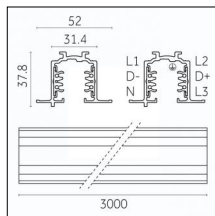

### Code 0.02036.0028 - 3-circuit track recessed

Finishing: Metallised grey (Standard)  
Length: 3000mm Width: 52mm Height: 37.8mm

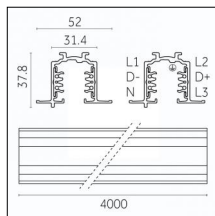

### Code 0.02037.0010 - 3-circuit track recessed

Finishing: White (Standard)  
Length: 4000mm Width: 52mm Height: 37.8mm

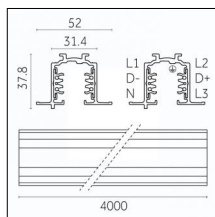

### Code 0.02037.0021 - 3-circuit track recessed

Finishing: Black (Standard)  
Length: 4000mm Width: 52mm Height: 37.8mm

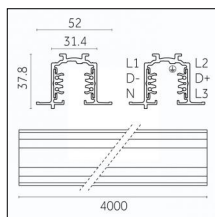

### Code 0.02037.0028 - 3-circuit track recessed

Finishing: Metallised grey (Standard)  
Length: 4000mm Width: 52mm Height: 37.8mm

Luminaire constructed in conformity with Directives 2014/35/EU (LV), 2014/30/EU (EMC), 2009/125/EC (Ecodesign) with Regulations (EC) No 245/2009, (EU) No 347/2010 and (EU) 2015/1428 (for luminaires with fluorescent and metal halide lamps only), 2009/125/EC (Ecodesign) with Regulations (EU) No 1194/2012 and 2015/1428 (for LED luminaires only), 2011/65/EU (RoHS 2) and 2012/19/EU (WEEE).

## Tracks/channels

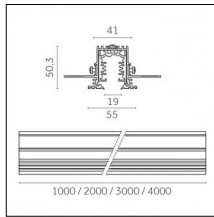
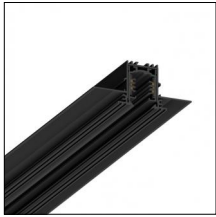

### Code 0.27101.0021 - 3-circuit track Supertrack

Finishing: Black (Standard)  
Length: 1000mm Width: 41mm Height: 50mm

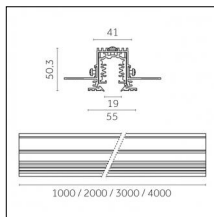

### Code 0.27102.0021 - 3-circuit track Supertrack

Finishing: Black (Standard)  
Length: 2000mm Width: 41mm Height: 50mm

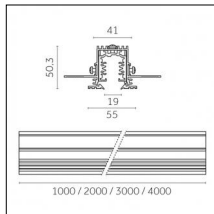

### Code 0.27103.0021 - 3-circuit track Supertrack

Finishing: Black (Standard)  
Length: 3000mm Width: 41mm Height: 50mm

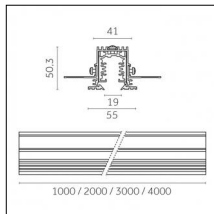

### Code 0.27104.0021 - 3-circuit track Supertrack

Finishing: Black (Standard)  
Length: 4000mm Width: 41mm Height: 50mm

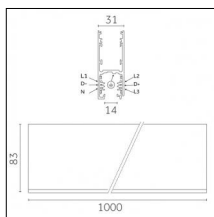
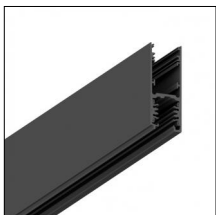

### Code 0.02505.0010 - H Track | Surface/Pendant

Finishing: White (Standard)  
Length: 1000mm Width: 31mm Height: 83mm

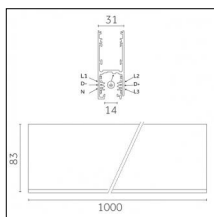
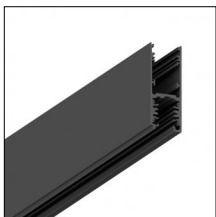

### Code 0.02505.0021 - H Track | Surface/Pendant

Finishing: Black (Standard)  
Length: 1000mm Width: 31mm Height: 83mm

Luminaire constructed in conformity with Directives 2014/35/EU (LV), 2014/30/EU (EMC), 2009/125/EC (Ecodesign) with Regulations (EC) No 245/2009, (EU) No 347/2010 and (EU) 2015/1428 (for luminaires with fluorescent and metal halide lamps only), 2009/125/EC (Ecodesign) with Regulations (EU) No 1194/2012 and 2015/1428 (for LED luminaires only), 2011/65/EU (RoHS 2) and 2012/19/EU (WEEE).

## Tracks/channels

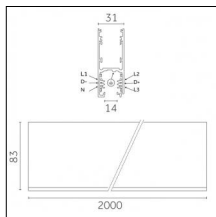

### Code 0.02506.0010 - H Track | Surface/Pendant

Finishing: White (Standard)  
Length: 2000mm Width: 31mm Height: 83mm

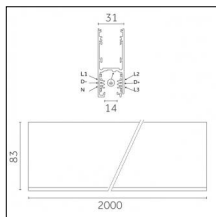

### Code 0.02506.0021 - H Track | Surface/Pendant

Finishing: Black (Standard)  
Length: 2000mm Width: 31mm Height: 83mm

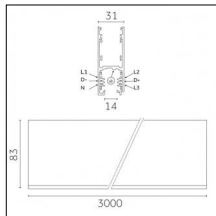

### Code 0.02507.0010 - H Track | Surface/Pendant

Finishing: White (Standard)  
Length: 3000mm Width: 31mm Height: 83mm

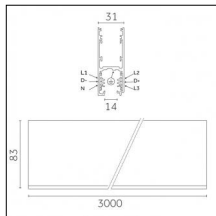

### Code 0.02507.0021 - H Track | Surface/Pendant

Finishing: Black (Standard)  
Length: 3000mm Width: 31mm Height: 83mm

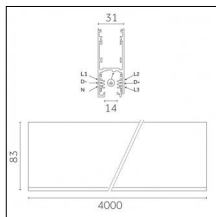

### Code 0.02508.0010 - H Track | Surface/Pendant

Finishing: White (Standard)  
Length: 4000mm Width: 31mm Height: 83mm

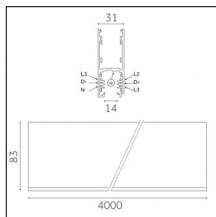

### Code 0.02508.0021 - H Track | Surface/Pendant

Finishing: Black (Standard)  
Length: 4000mm Width: 31mm Height: 83mm

Luminaire constructed in conformity with Directives 2014/35/EU (LV), 2014/30/EU (EMC), 2009/125/EC (Ecodesign) with Regulations (EC) No 245/2009, (EU) No 347/2010 and (EU) 2015/1428 (for luminaires with fluorescent and metal halide lamps only), 2009/125/EC (Ecodesign) with Regulations (EU) No 1194/2012 and 2015/1428 (for LED luminaires only), 2011/65/EU (RoHS 2) and 2012/19/EU (WEEE).

## Driver

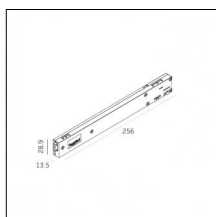

### Code 0.30455.0000 - Driver

Type: On-Off

Watt: 35W - AC Input: 220-244Vac - mA:900mA

Description: Connection options:

1X: 9-13pz

2X: 5-6pz

3X: 3-4pz

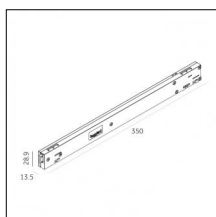

### Code D.30455.0000 - Driver

Type: DALI

Watt: 35W - AC Input: 120-277Vac - mA:900mA

Description: Connection options:

1X: 3-13pz

2X: 2-6pz

3x: 1-4pz

## Accessories

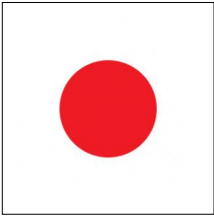

**Code 0.26710.004A - Red glass filter 1 mm**

Type: Optical  
Finishing: Red

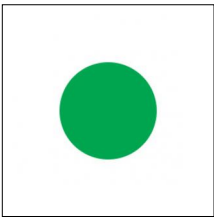

**Code 0.26710.005A - Green glass filter 1 mm**

Type: Optical  
Finishing: Green

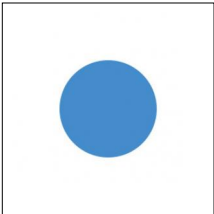

**Code 0.26710.006A - Blue glass filter 1 mm**

Type: Optical  
Finishing: Blue

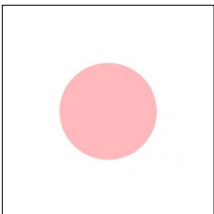

**Code 0.26710.007A - Pink glass filter 1 mm**

Type: Optical  
Finishing: Pink

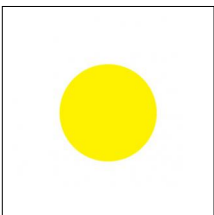

**Code 0.26710.008A - Yellow glass filter 1 mm**

Type: Optical  
Finishing: Yellow

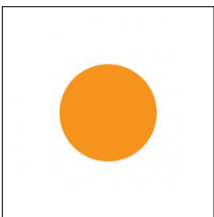

**Code 0.26710.009A - Orange glass filter 1 mm**

Type: Optical  
Finishing: Orange



## Accessories

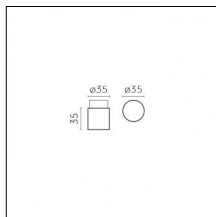

### Code 0.26042.0000 - Cylinder, Full version

Type: Optical  
Finishing: Without finish / Stainles Steel / Natural aluminium (Standard)  
Height: 35mm  
Description: Full version

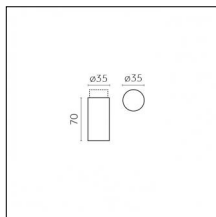

### Code 0.26043.0000 - Cylinder, Full version

Type: Optical  
Finishing: Without finish / Stainles Steel / Natural aluminium (Standard)  
Height: 70mm  
Description: Full version

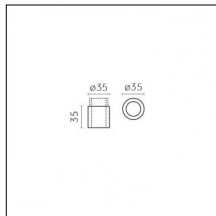

### Code 0.26044.0000 - Cylinder, Hollow version

Type: Optical  
Finishing: Without finish / Stainles Steel / Natural aluminium (Standard)  
Height: 35mm  
Description: Hollow version



### Code 0.26045.0000 - Cylinder, Hollow version

Type: Optical  
Finishing: Without finish / Stainles Steel / Natural aluminium (Standard)  
Height: 70mm  
Description: Hollow version

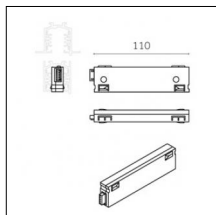

### Code 0.26500.0000 - Standard spacer - 110mm

Type: Structural  
Finishing: Without finish / Stainles Steel / Natural aluminium (Standard)  
Length: 110mm

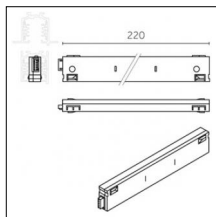

### Code 0.26501.0000 - Standard spacer - 220mm

Type: Structural  
Finishing: Without finish / Stainles Steel / Natural aluminium (Standard)  
Length: 220mm

Luminaire constructed in conformity with Directives 2014/35/EU (LV), 2014/30/EU (EMC), 2009/125/EC (Ecodesign) with Regulations (EC) No 245/2009, (EU) No 347/2010 and (EU) 2015/1428 (for luminaires with fluorescent and metal halide lamps only), 2009/125/EC (Ecodesign) with Regulations (EU) No 1194/2012 and 2015/1428 (for LED luminaires only), 2011/65/EU (RoHS 2) and 2012/19/EU (WEEE).

## Accessories

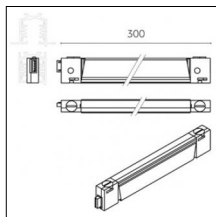

### Code 0.26502.0000 - Customizable spacer - 300mm

Type: Structural  
Finishing: Without finish / Stainles Steel / Natural aluminium (Standard)  
Length: 300mm

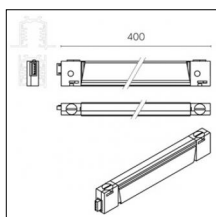

### Code 0.26503.0000 - Customizable spacer - 400mm

Type: Structural  
Finishing: Without finish / Stainles Steel / Natural aluminium (Standard)  
Length: 400mm

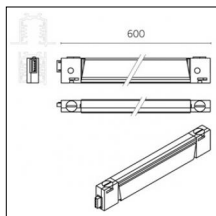

### Code 0.26504.0000 - Customizable spacer - 600mm

Type: Structural  
Finishing: Without finish / Stainles Steel / Natural aluminium (Standard)  
Length: 600mm

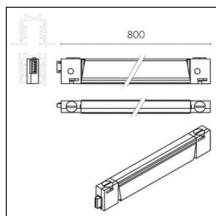

### Code 0.26505.0000 - Customizable spacer - 800mm

Type: Structural  
Finishing: Without finish / Stainles Steel / Natural aluminium (Standard)  
Length: 800mm

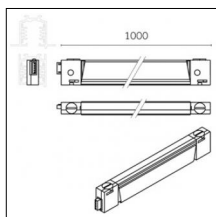

### Code 0.26506.0000 - Customizable spacer - 1000mm

Type: Structural  
Finishing: Without finish / Stainles Steel / Natural aluminium (Standard)  
Length: 1000mm

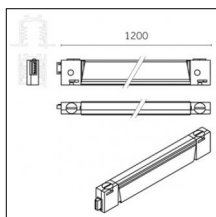

### Code 0.26507.0000 - Customizable spacer - 1200mm

Type: Structural  
Finishing: Without finish / Stainles Steel / Natural aluminium (Standard)  
Length: 1200mm

## Accessories

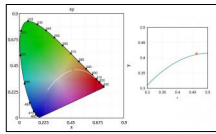

**Code 0.26711.0000 - Selective filter 3000K-2700K**

Type: Optical

Finishing: Without finish / Stainles Steel / Natural aluminium (Standard)

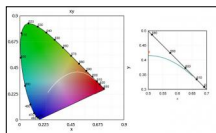
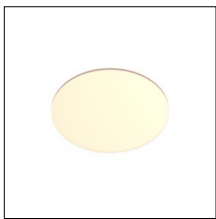

**Code 0.26712.0000 - Selective filter 2700K - 2500K**

Type: Optical

Finishing: Without finish / Stainles Steel / Natural aluminium (Standard)

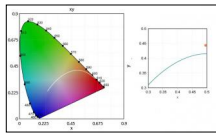
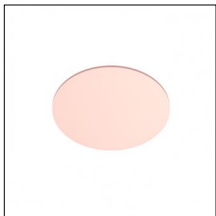

**Code 0.26713.0000 - Selective filter 2700K - 2200K**

Type: Optical

Finishing: Without finish / Stainles Steel / Natural aluminium (Standard)

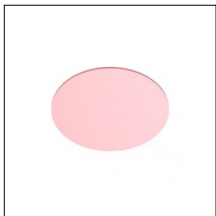

**Code 0.26714.0000 - Selective filter 2700K - 2000K**

Type: Optical

Finishing: Without finish / Stainles Steel / Natural aluminium (Standard)

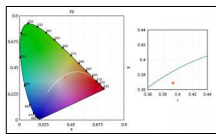
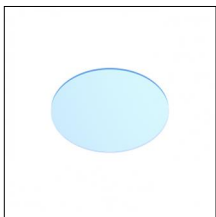

**Code 0.26715.0000 - Selective filter 3000K-3600K**

Type: Optical

Finishing: Without finish / Stainles Steel / Natural aluminium (Standard)

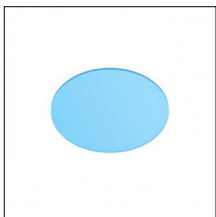

**Code 0.26716.0000 - Selective filter 3000K-4000K**

Type: Optical

Finishing: Without finish / Stainles Steel / Natural aluminium (Standard)

## Accessories

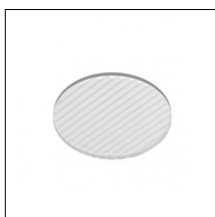

### Code 0.26717.0000 - Elliptical beam lens

Type: Optical

Finishing: Without finish / Stainles Steel / Natural aluminium (Standard)

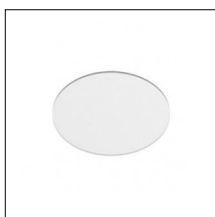

### Code 0.26718.0000 - Opal lens

Type: Optical

Finishing: Without finish / Stainles Steel / Natural aluminium (Standard)

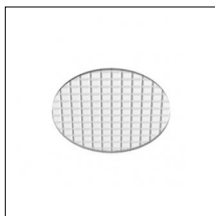

### Code 0.26719.0000 - Diffusive lens

Type: Optical

Finishing: Without finish / Stainles Steel / Natural aluminium (Standard)

Indoor | Pendants | Yori Pendant Ghostrack Ø35mm

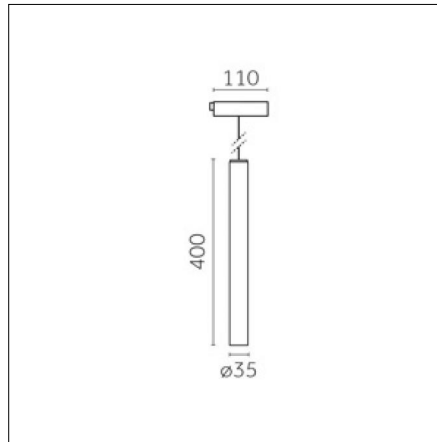

Very narrow 10°



IP20



Risk 1

850°



**Code X.GM71B.HWD0**

### Light source features

**Number of light sources:** 1

**Source type:** LED HW

**Watt:** 2.7W

**Lm:** 270lm

**Lm/W:** 100lm/W

**Kelvin/CRI:** 2700K / >90

**SDCM/L90 B10:** < 3 / 50000

### Electrical features

**Driver included:** NO

**Driver position:** remote

**Driver type:** no driver included

**Isolation class:** Class III

### Optical features

**Beam angle:** 10°

**Optical type, adjustability:** Fixed

**Interchangeable optic (IOS):** NO

### Physical features

**Material:** Die-cast aluminum

**Mounting:** Track, Suspension

**Finishing:** Brushed brass

**Weight:** 0.5Kg

### Notes:

Cable length 3m

Luminaire constructed in conformity with Directives 2014/35/EU (LV), 2014/30/EU (EMC), 2009/125/EC (Ecodesign) with Regulations (EC) No 245/2009, (EU) No 347/2010 and (EU) 2015/1428 (for luminaires with fluorescent and metal halide lamps only), 2009/125/EC (Ecodesign) with Regulations (EU) No 1194/2012 and 2015/1428 (for LED luminaires only), 2011/65/EU (RoHS 2) and 2012/19/EU (WEEE).

### Reggiani SPA Illuminazione

Viale Monza, 16 20845 Sovico (MB) Italy  
Tel. (+39) 039 2071.1 fax (+39) 039 2071 999

www.reggiani.net  
contact@reggiani.net

## Photometries



## Tracks/channels

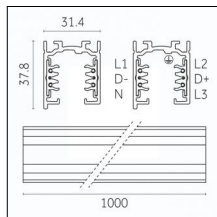

**Code 0.02030.0010 - 3-circuit track surface/pendant**

Finishing: White (Standard)  
Length: 1000mm Width: 31.4mm Height: 37.8mm

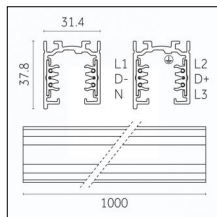

**Code 0.02030.0021 - 3-circuit track surface/pendant**

Finishing: Black (Standard)  
Length: 1000mm Width: 31.4mm Height: 37.8mm

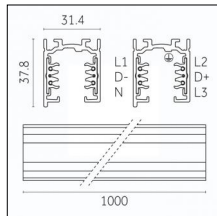
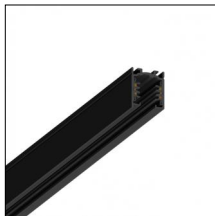

**Code 0.02030.0028 - 3-circuit track surface/pendant**

Finishing: Metallised grey (Standard)  
Length: 1000mm Width: 31.4mm Height: 37.8mm

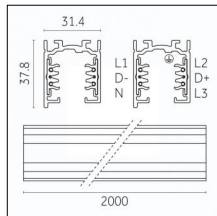

**Code 0.02031.0010 - 3-circuit track surface/pendant**

Finishing: White (Standard)  
Length: 2000mm Width: 31.4mm Height: 37.8mm

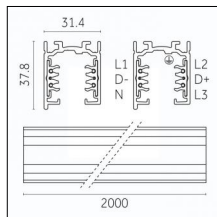
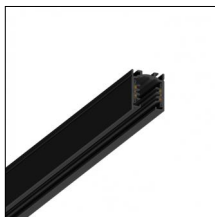

**Code 0.02031.0021 - 3-circuit track surface/pendant**

Finishing: Black (Standard)  
Length: 2000mm Width: 31.4mm Height: 37.8mm

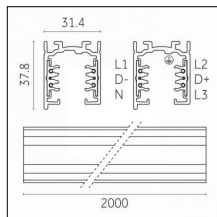

**Code 0.02031.0028 - 3-circuit track surface/pendant**

Finishing: Metallised grey (Standard)  
Length: 2000mm Width: 31.4mm Height: 37.8mm

Luminaire constructed in conformity with Directives 2014/35/EU (LV), 2014/30/EU (EMC), 2009/125/EC (Ecodesign) with Regulations (EC) No 245/2009, (EU) No 347/2010 and (EU) 2015/1428 (for luminaires with fluorescent and metal halide lamps only), 2009/125/EC (Ecodesign) with Regulations (EU) No 1194/2012 and 2015/1428 (for LED luminaires only), 2011/65/EU (RoHS 2) and 2012/19/EU (WEEE).

## Tracks/channels

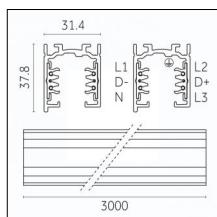

### Code 0.02032.0010 - 3-circuit track surface/pendant

Finishing: White (Standard)  
Length: 3000mm Width: 31.4mm Height: 37.8mm

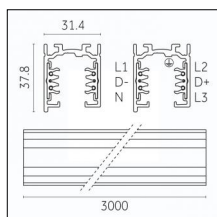
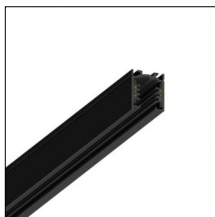

### Code 0.02032.0021 - 3-circuit track surface/pendant

Finishing: Black (Standard)  
Length: 3000mm Width: 31.4mm Height: 37.8mm

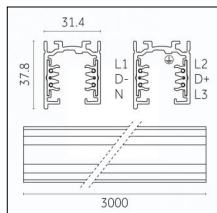

### Code 0.02032.0028 - 3-circuit track surface/pendant

Finishing: Metallised grey (Standard)  
Length: 3000mm Width: 31.4mm Height: 37.8mm

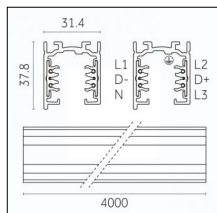

### Code 0.02033.0010 - 3-circuit track surface/pendant

Finishing: White (Standard)  
Length: 4000mm Width: 31.4mm Height: 37.8mm

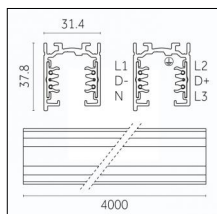
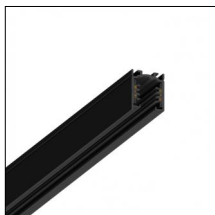

### Code 0.02033.0021 - 3-circuit track surface/pendant

Finishing: Black (Standard)  
Length: 4000mm Width: 31.4mm Height: 37.8mm

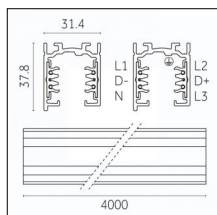
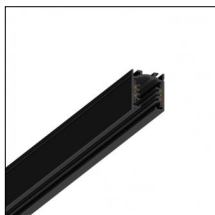

### Code 0.02033.0028 - 3-circuit track surface/pendant

Finishing: Metallised grey (Standard)  
Length: 4000mm Width: 31.4mm Height: 37.8mm

Luminaire constructed in conformity with Directives 2014/35/EU (LV), 2014/30/EU (EMC), 2009/125/EC (Ecodesign) with Regulations (EC) No 245/2009, (EU) No 347/2010 and (EU) 2015/1428 (for luminaires with fluorescent and metal halide lamps only), 2009/125/EC (Ecodesign) with Regulations (EU) No 1194/2012 and 2015/1428 (for LED luminaires only), 2011/65/EU (RoHS 2) and 2012/19/EU (WEEE).



## Tracks/channels

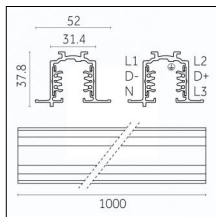

**Code 0.02034.0010 - 3-circuit track recessed**

Finishing: White (Standard)  
Length: 1000mm Width: 52mm Height: 37.8mm

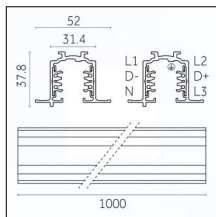

**Code 0.02034.0021 - 3-circuit track recessed**

Finishing: Black (Standard)  
Length: 1000mm Width: 52mm Height: 37.8mm

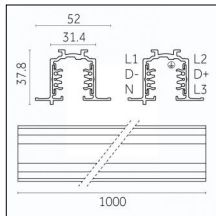

**Code 0.02034.0028 - 3-circuit track recessed**

Finishing: Metallised grey (Standard)  
Length: 1000mm Width: 52mm Height: 37.8mm

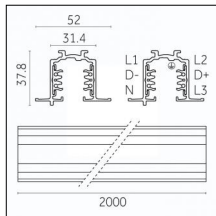

**Code 0.02035.0010 - 3-circuit track recessed**

Finishing: White (Standard)  
Length: 2000mm Width: 52mm Height: 37.8mm

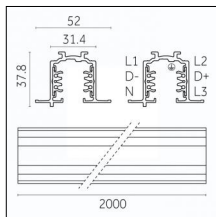

**Code 0.02035.0021 - 3-circuit track recessed**

Finishing: Black (Standard)  
Length: 2000mm Width: 52mm Height: 37.8mm

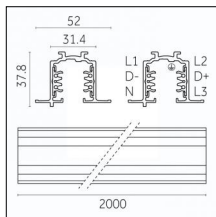

**Code 0.02035.0028 - 3-circuit track recessed**

Finishing: Metallised grey (Standard)  
Length: 2000mm Width: 52mm Height: 37.8mm

Luminaire constructed in conformity with Directives 2014/35/EU (LV), 2014/30/EU (EMC), 2009/125/EC (Ecodesign) with Regulations (EC) No 245/2009, (EU) No 347/2010 and (EU) 2015/1428 (for luminaires with fluorescent and metal halide lamps only), 2009/125/EC (Ecodesign) with Regulations (EU) No 1194/2012 and 2015/1428 (for LED luminaires only), 2011/65/EU (RoHS 2) and 2012/19/EU (WEEE).

## Tracks/channels

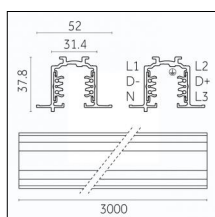

**Code 0.02036.0010 - 3-circuit track recessed**

Finishing: White (Standard)  
Length: 3000mm Width: 52mm Height: 37.8mm

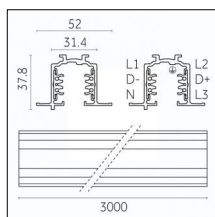

**Code 0.02036.0021 - 3-circuit track recessed**

Finishing: Black (Standard)  
Length: 3000mm Width: 52mm Height: 37.8mm

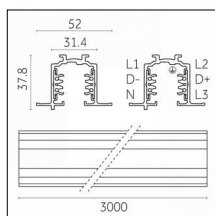

**Code 0.02036.0028 - 3-circuit track recessed**

Finishing: Metallised grey (Standard)  
Length: 3000mm Width: 52mm Height: 37.8mm

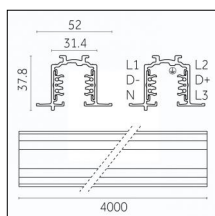

**Code 0.02037.0010 - 3-circuit track recessed**

Finishing: White (Standard)  
Length: 4000mm Width: 52mm Height: 37.8mm

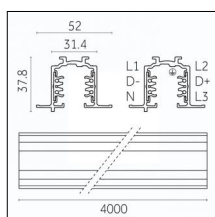

**Code 0.02037.0021 - 3-circuit track recessed**

Finishing: Black (Standard)  
Length: 4000mm Width: 52mm Height: 37.8mm

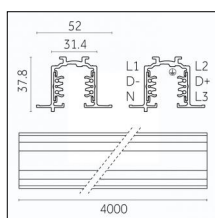

**Code 0.02037.0028 - 3-circuit track recessed**

Finishing: Metallised grey (Standard)  
Length: 4000mm Width: 52mm Height: 37.8mm

Luminaire constructed in conformity with Directives 2014/35/EU (LV), 2014/30/EU (EMC), 2009/125/EC (Ecodesign) with Regulations (EC) No 245/2009, (EU) No 347/2010 and (EU) 2015/1428 (for luminaires with fluorescent and metal halide lamps only), 2009/125/EC (Ecodesign) with Regulations (EU) No 1194/2012 and 2015/1428 (for LED luminaires only), 2011/65/EU (RoHS 2) and 2012/19/EU (WEEE).

## Tracks/channels

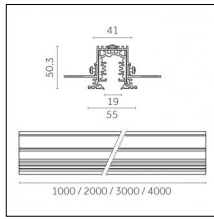

### Code 0.27101.0021 - 3-circuit track Supertrack

Finishing: Black (Standard)  
Length: 1000mm Width: 41mm Height: 50mm

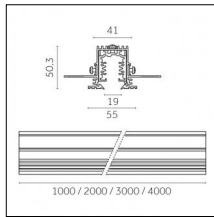

### Code 0.27102.0021 - 3-circuit track Supertrack

Finishing: Black (Standard)  
Length: 2000mm Width: 41mm Height: 50mm

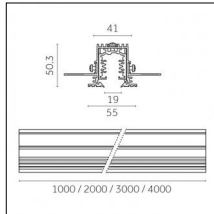

### Code 0.27103.0021 - 3-circuit track Supertrack

Finishing: Black (Standard)  
Length: 3000mm Width: 41mm Height: 50mm

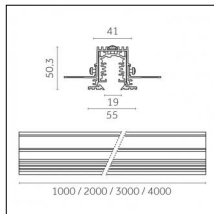

### Code 0.27104.0021 - 3-circuit track Supertrack

Finishing: Black (Standard)  
Length: 4000mm Width: 41mm Height: 50mm

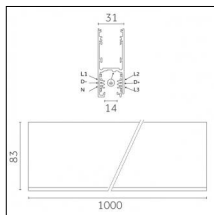
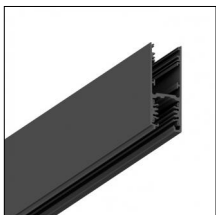

### Code 0.02505.0010 - H Track | Surface/Pendant

Finishing: White (Standard)  
Length: 1000mm Width: 31mm Height: 83mm

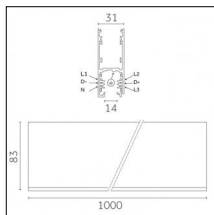
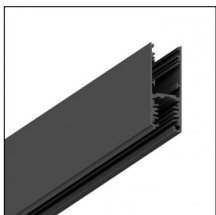

### Code 0.02505.0021 - H Track | Surface/Pendant

Finishing: Black (Standard)  
Length: 1000mm Width: 31mm Height: 83mm

Luminaire constructed in conformity with Directives 2014/35/EU (LV), 2014/30/EU (EMC), 2009/125/EC (Ecodesign) with Regulations (EC) No 245/2009, (EU) No 347/2010 and (EU) 2015/1428 (for luminaires with fluorescent and metal halide lamps only), 2009/125/EC (Ecodesign) with Regulations (EU) No 1194/2012 and 2015/1428 (for LED luminaires only), 2011/65/EU (RoHS 2) and 2012/19/EU (WEEE).

## Tracks/channels

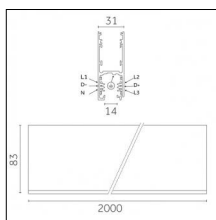
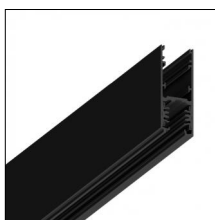

### Code 0.02506.0010 - H Track | Surface/Pendant

Finishing: White (Standard)  
Length: 2000mm Width: 31mm Height: 83mm

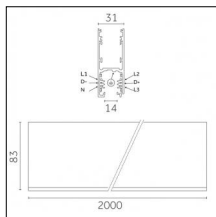

### Code 0.02506.0021 - H Track | Surface/Pendant

Finishing: Black (Standard)  
Length: 2000mm Width: 31mm Height: 83mm

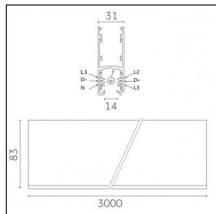

### Code 0.02507.0010 - H Track | Surface/Pendant

Finishing: White (Standard)  
Length: 3000mm Width: 31mm Height: 83mm

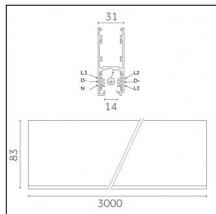
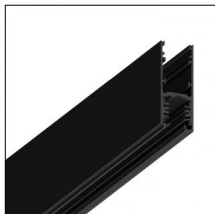

### Code 0.02507.0021 - H Track | Surface/Pendant

Finishing: Black (Standard)  
Length: 3000mm Width: 31mm Height: 83mm

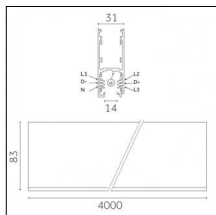

### Code 0.02508.0010 - H Track | Surface/Pendant

Finishing: White (Standard)  
Length: 4000mm Width: 31mm Height: 83mm

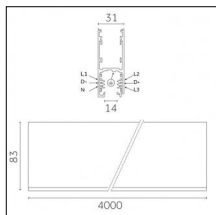

### Code 0.02508.0021 - H Track | Surface/Pendant

Finishing: Black (Standard)  
Length: 4000mm Width: 31mm Height: 83mm

Luminaire constructed in conformity with Directives 2014/35/EU (LV), 2014/30/EU (EMC), 2009/125/EC (Ecodesign) with Regulations (EC) No 245/2009, (EU) No 347/2010 and (EU) 2015/1428 (for luminaires with fluorescent and metal halide lamps only), 2009/125/EC (Ecodesign) with Regulations (EU) No 1194/2012 and 2015/1428 (for LED luminaires only), 2011/65/EU (RoHS 2) and 2012/19/EU (WEEE).

## Driver

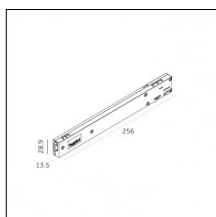

### Code 0.30455.0000 - Driver

Type: On-Off

Watt: 35W - AC Input: 220-244Vac - mA:900mA

Description: Connection options:

1X: 9-13pz

2X: 5-6pz

3X: 3-4pz

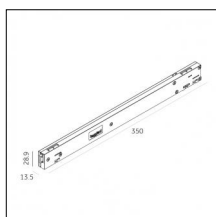

### Code D.30455.0000 - Driver

Type: DALI

Watt: 35W - AC Input: 120-277Vac - mA:900mA

Description: Connection options:

1X: 3-13pz

2X: 2-6pz

3x: 1-4pz

## Accessories

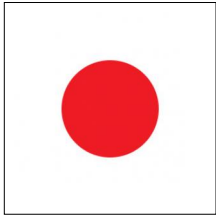

**Code 0.26710.004A - Red glass filter 1 mm**

Type: Optical  
Finishing: Red

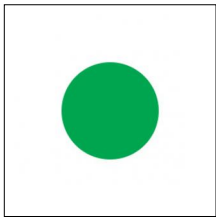

**Code 0.26710.005A - Green glass filter 1 mm**

Type: Optical  
Finishing: Green

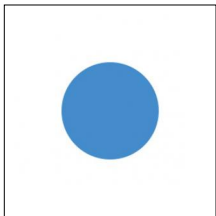

**Code 0.26710.006A - Blue glass filter 1 mm**

Type: Optical  
Finishing: Blue

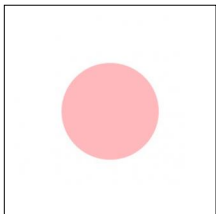

**Code 0.26710.007A - Pink glass filter 1 mm**

Type: Optical  
Finishing: Pink

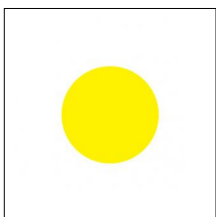

**Code 0.26710.008A - Yellow glass filter 1 mm**

Type: Optical  
Finishing: Yellow

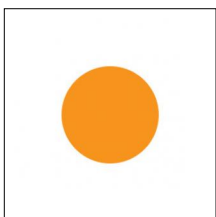

**Code 0.26710.009A - Orange glass filter 1 mm**

Type: Optical  
Finishing: Orange

## Accessories

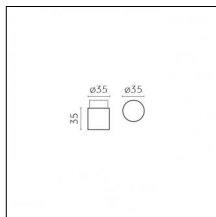

### Code 0.26042.0000 - Cylinder, Full version

Type: Optical  
 Finishing: Without finish / Stainles Steel / Natural aluminium (Standard)  
 Height: 35mm  
 Description: Full version

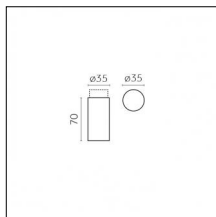

### Code 0.26043.0000 - Cylinder, Full version

Type: Optical  
 Finishing: Without finish / Stainles Steel / Natural aluminium (Standard)  
 Height: 70mm  
 Description: Full version

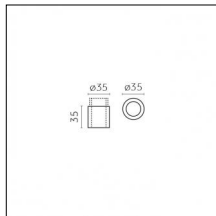

### Code 0.26044.0000 - Cylinder, Hollow version

Type: Optical  
 Finishing: Without finish / Stainles Steel / Natural aluminium (Standard)  
 Height: 35mm  
 Description: Hollow version



### Code 0.26045.0000 - Cylinder, Hollow version

Type: Optical  
 Finishing: Without finish / Stainles Steel / Natural aluminium (Standard)  
 Height: 70mm  
 Description: Hollow version

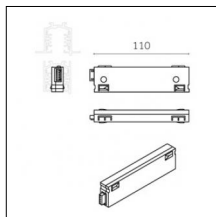

### Code 0.26500.0000 - Standard spacer - 110mm

Type: Structural  
 Finishing: Without finish / Stainles Steel / Natural aluminium (Standard)  
 Length: 110mm

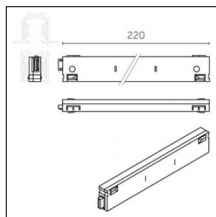

### Code 0.26501.0000 - Standard spacer - 220mm

Type: Structural  
 Finishing: Without finish / Stainles Steel / Natural aluminium (Standard)  
 Length: 220mm

Luminaire constructed in conformity with Directives 2014/35/EU (LV), 2014/30/EU (EMC), 2009/125/EC (Ecodesign) with Regulations (EC) No 245/2009, (EU) No 347/2010 and (EU) 2015/1428 (for luminaires with fluorescent and metal halide lamps only), 2009/125/EC (Ecodesign) with Regulations (EU) No 1194/2012 and 2015/1428 (for LED luminaires only), 2011/65/EU (RoHS 2) and 2012/19/EU (WEEE).

## Accessories

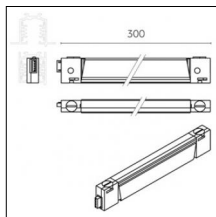

### Code 0.26502.0000 - Customizable spacer - 300mm

Type: Structural  
Finishing: Without finish / Stainles Steel / Natural aluminium (Standard)  
Length: 300mm

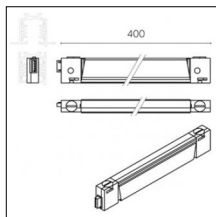

### Code 0.26503.0000 - Customizable spacer - 400mm

Type: Structural  
Finishing: Without finish / Stainles Steel / Natural aluminium (Standard)  
Length: 400mm

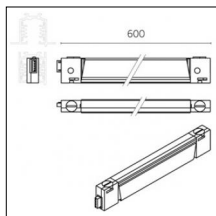

### Code 0.26504.0000 - Customizable spacer - 600mm

Type: Structural  
Finishing: Without finish / Stainles Steel / Natural aluminium (Standard)  
Length: 600mm

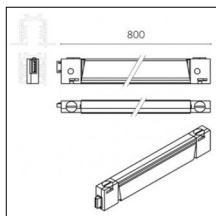

### Code 0.26505.0000 - Customizable spacer - 800mm

Type: Structural  
Finishing: Without finish / Stainles Steel / Natural aluminium (Standard)  
Length: 800mm

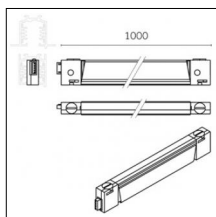

### Code 0.26506.0000 - Customizable spacer - 1000mm

Type: Structural  
Finishing: Without finish / Stainles Steel / Natural aluminium (Standard)  
Length: 1000mm

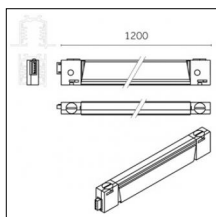

### Code 0.26507.0000 - Customizable spacer - 1200mm

Type: Structural  
Finishing: Without finish / Stainles Steel / Natural aluminium (Standard)  
Length: 1200mm



## Accessories

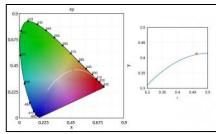

**Code 0.26711.0000 - Selective filter 3000K-2700K**

Type: Optical

Finishing: Without finish / Stainles Steel / Natural aluminium (Standard)

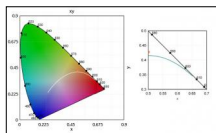
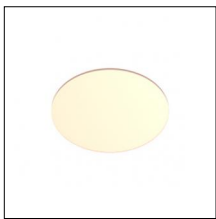

**Code 0.26712.0000 - Selective filter 2700K - 2500K**

Type: Optical

Finishing: Without finish / Stainles Steel / Natural aluminium (Standard)

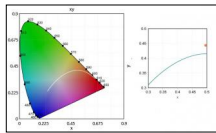
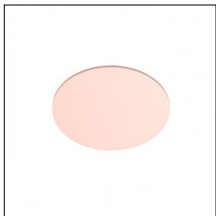

**Code 0.26713.0000 - Selective filter 2700K - 2200K**

Type: Optical

Finishing: Without finish / Stainles Steel / Natural aluminium (Standard)

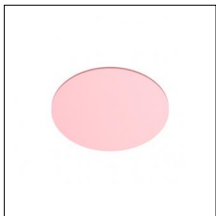

**Code 0.26714.0000 - Selective filter 2700K - 2000K**

Type: Optical

Finishing: Without finish / Stainles Steel / Natural aluminium (Standard)

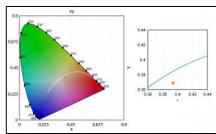
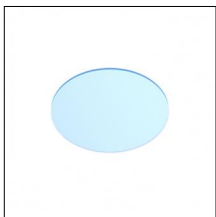

**Code 0.26715.0000 - Selective filter 3000K-3600K**

Type: Optical

Finishing: Without finish / Stainles Steel / Natural aluminium (Standard)

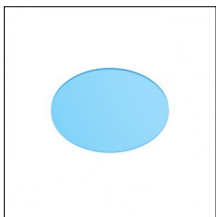

**Code 0.26716.0000 - Selective filter 3000K-4000K**

Type: Optical

Finishing: Without finish / Stainles Steel / Natural aluminium (Standard)

## Accessories

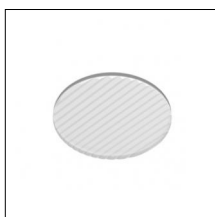

### Code 0.26717.0000 - Elliptical beam lens

Type: Optical

Finishing: Without finish / Stainles Steel / Natural aluminium (Standard)

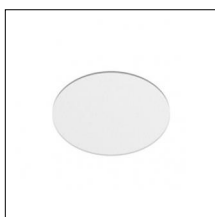

### Code 0.26718.0000 - Opal lens

Type: Optical

Finishing: Without finish / Stainles Steel / Natural aluminium (Standard)

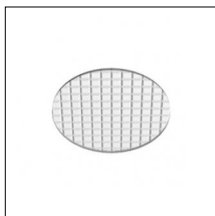

### Code 0.26719.0000 - Diffusive lens

Type: Optical

Finishing: Without finish / Stainles Steel / Natural aluminium (Standard)

Indoor | Pendants | Yori Pendant Ghostrack Ø35mm

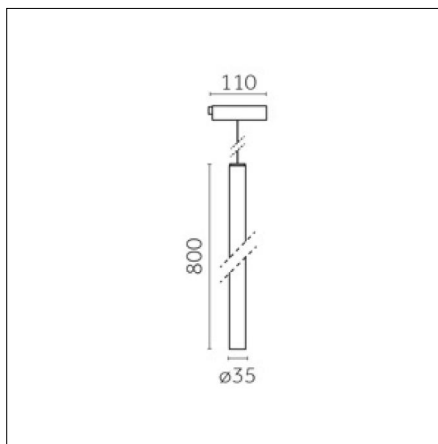

Very narrow 10°

01

IP20



Risk 1

850°



**Code X.HM71B.HW01**

### Light source features

**Number of light sources:** 1

**Source type:** LED HW

**Watt:** 2.7W

**Lm:** 270lm

**Lm/W:** 100lm/W

**Kelvin/CRI:** 2700K / >90

**SDCM/L90 B10:** < 3 / 50000

### Electrical features

**Driver included:** NO

**Driver position:** remote

**Driver type:** no driver included

**Isolation class:** Class III

### Optical features

**Beam angle:** 10°

**Optical type, adjustability:** Fixed

**Interchangeable optic (IOS):** NO

### Physical features

**Material:** Die-cast aluminum

**Mounting:** Track, Suspension

**Finishing:** Chrome

**Weight:** 0.7Kg

### Notes:

Cable length 3m

Luminaire constructed in conformity with Directives 2014/35/EU (LV), 2014/30/EU (EMC), 2009/125/EC (Ecodesign) with Regulations (EC) No 245/2009, (EU) No 347/2010 and (EU) 2015/1428 (for luminaires with fluorescent and metal halide lamps only), 2009/125/EC (Ecodesign) with Regulations (EU) No 1194/2012 and 2015/1428 (for LED luminaires only), 2011/65/EU (RoHS 2) and 2012/19/EU (WEEE).

### Reggiani SPA Illuminazione

Viale Monza, 16 20845 Sovico (MB) Italy  
Tel. (+39) 039 2071.1 fax (+39) 039 2071 999

www.reggiani.net  
contact@reggiani.net

## Photometries



## Tracks/channels

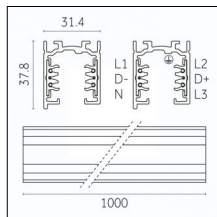
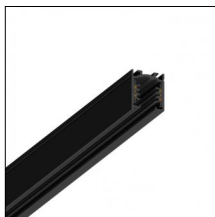

**Code 0.02030.0010 - 3-circuit track surface/pendant**

Finishing: White (Standard)  
Length: 1000mm Width: 31.4mm Height: 37.8mm

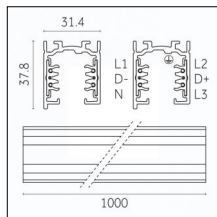

**Code 0.02030.0021 - 3-circuit track surface/pendant**

Finishing: Black (Standard)  
Length: 1000mm Width: 31.4mm Height: 37.8mm

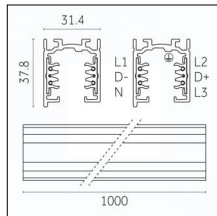
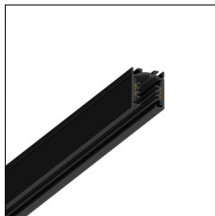

**Code 0.02030.0028 - 3-circuit track surface/pendant**

Finishing: Metallised grey (Standard)  
Length: 1000mm Width: 31.4mm Height: 37.8mm

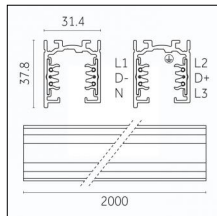

**Code 0.02031.0010 - 3-circuit track surface/pendant**

Finishing: White (Standard)  
Length: 2000mm Width: 31.4mm Height: 37.8mm

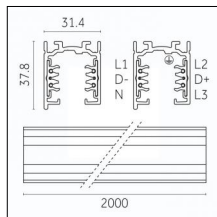

**Code 0.02031.0021 - 3-circuit track surface/pendant**

Finishing: Black (Standard)  
Length: 2000mm Width: 31.4mm Height: 37.8mm

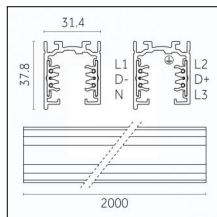

**Code 0.02031.0028 - 3-circuit track surface/pendant**

Finishing: Metallised grey (Standard)  
Length: 2000mm Width: 31.4mm Height: 37.8mm

Luminaire constructed in conformity with Directives 2014/35/EU (LV), 2014/30/EU (EMC), 2009/125/EC (Ecodesign) with Regulations (EC) No 245/2009, (EU) No 347/2010 and (EU) 2015/1428 (for luminaires with fluorescent and metal halide lamps only), 2009/125/EC (Ecodesign) with Regulations (EU) No 1194/2012 and 2015/1428 (for LED luminaires only), 2011/65/EU (RoHS 2) and 2012/19/EU (WEEE).

## Tracks/channels

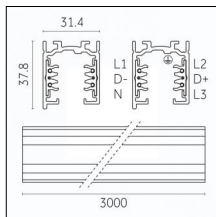

**Code 0.02032.0010 - 3-circuit track surface/pendant**

Finishing: White (Standard)  
Length: 3000mm Width: 31.4mm Height: 37.8mm

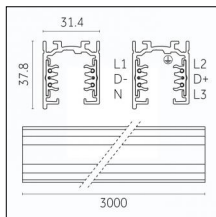

**Code 0.02032.0021 - 3-circuit track surface/pendant**

Finishing: Black (Standard)  
Length: 3000mm Width: 31.4mm Height: 37.8mm

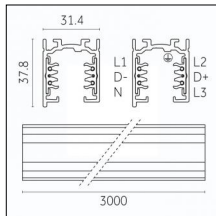

**Code 0.02032.0028 - 3-circuit track surface/pendant**

Finishing: Metallised grey (Standard)  
Length: 3000mm Width: 31.4mm Height: 37.8mm

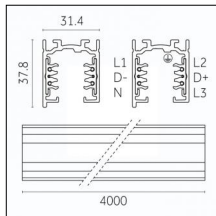

**Code 0.02033.0010 - 3-circuit track surface/pendant**

Finishing: White (Standard)  
Length: 4000mm Width: 31.4mm Height: 37.8mm

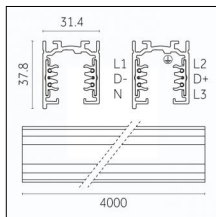

**Code 0.02033.0021 - 3-circuit track surface/pendant**

Finishing: Black (Standard)  
Length: 4000mm Width: 31.4mm Height: 37.8mm

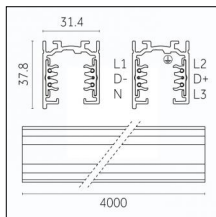

**Code 0.02033.0028 - 3-circuit track surface/pendant**

Finishing: Metallised grey (Standard)  
Length: 4000mm Width: 31.4mm Height: 37.8mm

Luminaire constructed in conformity with Directives 2014/35/EU (LV), 2014/30/EU (EMC), 2009/125/EC (Ecodesign) with Regulations (EC) No 245/2009, (EU) No 347/2010 and (EU) 2015/1428 (for luminaires with fluorescent and metal halide lamps only), 2009/125/EC (Ecodesign) with Regulations (EU) No 1194/2012 and 2015/1428 (for LED luminaires only), 2011/65/EU (RoHS 2) and 2012/19/EU (WEEE).

## Tracks/channels

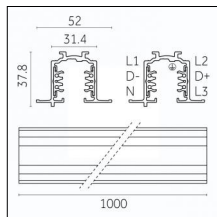

**Code 0.02034.0010 - 3-circuit track recessed**

Finishing: White (Standard)  
Length: 1000mm Width: 52mm Height: 37.8mm

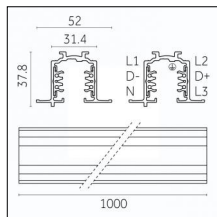

**Code 0.02034.0021 - 3-circuit track recessed**

Finishing: Black (Standard)  
Length: 1000mm Width: 52mm Height: 37.8mm

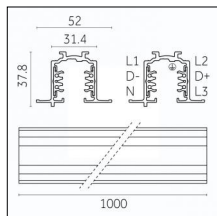

**Code 0.02034.0028 - 3-circuit track recessed**

Finishing: Metallised grey (Standard)  
Length: 1000mm Width: 52mm Height: 37.8mm

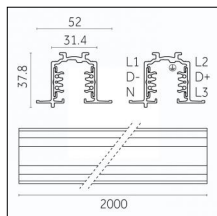

**Code 0.02035.0010 - 3-circuit track recessed**

Finishing: White (Standard)  
Length: 2000mm Width: 52mm Height: 37.8mm

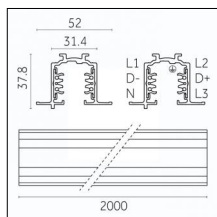

**Code 0.02035.0021 - 3-circuit track recessed**

Finishing: Black (Standard)  
Length: 2000mm Width: 52mm Height: 37.8mm

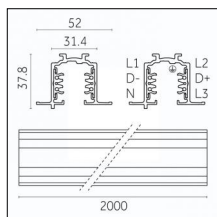

**Code 0.02035.0028 - 3-circuit track recessed**

Finishing: Metallised grey (Standard)  
Length: 2000mm Width: 52mm Height: 37.8mm

Luminaire constructed in conformity with Directives 2014/35/EU (LV), 2014/30/EU (EMC), 2009/125/EC (Ecodesign) with Regulations (EC) No 245/2009, (EU) No 347/2010 and (EU) 2015/1428 (for luminaires with fluorescent and metal halide lamps only), 2009/125/EC (Ecodesign) with Regulations (EU) No 1194/2012 and 2015/1428 (for LED luminaires only), 2011/65/EU (RoHS 2) and 2012/19/EU (WEEE).

## Tracks/channels

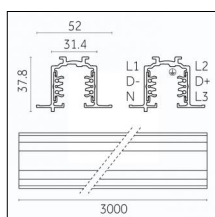

### Code 0.02036.0010 - 3-circuit track recessed

Finishing: White (Standard)  
Length: 3000mm Width: 52mm Height: 37.8mm

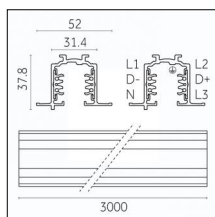

### Code 0.02036.0021 - 3-circuit track recessed

Finishing: Black (Standard)  
Length: 3000mm Width: 52mm Height: 37.8mm

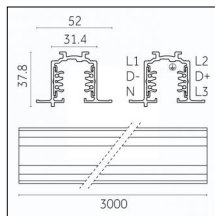

### Code 0.02036.0028 - 3-circuit track recessed

Finishing: Metallised grey (Standard)  
Length: 3000mm Width: 52mm Height: 37.8mm

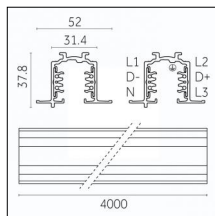
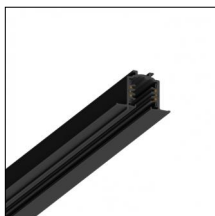

### Code 0.02037.0010 - 3-circuit track recessed

Finishing: White (Standard)  
Length: 4000mm Width: 52mm Height: 37.8mm

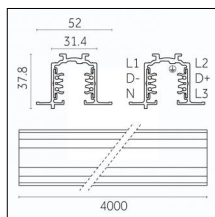

### Code 0.02037.0021 - 3-circuit track recessed

Finishing: Black (Standard)  
Length: 4000mm Width: 52mm Height: 37.8mm

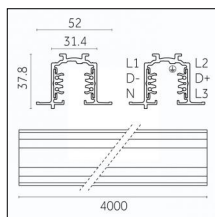

### Code 0.02037.0028 - 3-circuit track recessed

Finishing: Metallised grey (Standard)  
Length: 4000mm Width: 52mm Height: 37.8mm

Luminaire constructed in conformity with Directives 2014/35/EU (LV), 2014/30/EU (EMC), 2009/125/EC (Ecodesign) with Regulations (EC) No 245/2009, (EU) No 347/2010 and (EU) 2015/1428 (for luminaires with fluorescent and metal halide lamps only), 2009/125/EC (Ecodesign) with Regulations (EU) No 1194/2012 and 2015/1428 (for LED luminaires only), 2011/65/EU (RoHS 2) and 2012/19/EU (WEEE).



## Tracks/channels

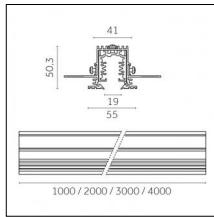

### Code 0.27101.0021 - 3-circuit track Supertrack

Finishing: Black (Standard)  
Length: 1000mm Width: 41mm Height: 50mm

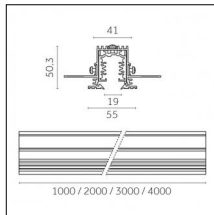

### Code 0.27102.0021 - 3-circuit track Supertrack

Finishing: Black (Standard)  
Length: 2000mm Width: 41mm Height: 50mm

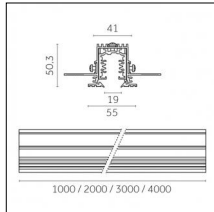

### Code 0.27103.0021 - 3-circuit track Supertrack

Finishing: Black (Standard)  
Length: 3000mm Width: 41mm Height: 50mm

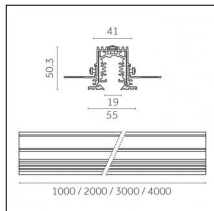

### Code 0.27104.0021 - 3-circuit track Supertrack

Finishing: Black (Standard)  
Length: 4000mm Width: 41mm Height: 50mm

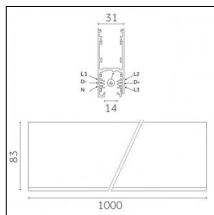
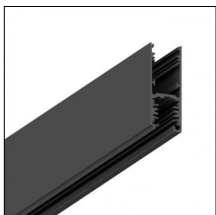

### Code 0.02505.0010 - H Track | Surface/Pendant

Finishing: White (Standard)  
Length: 1000mm Width: 31mm Height: 83mm

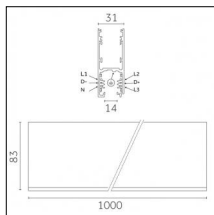

### Code 0.02505.0021 - H Track | Surface/Pendant

Finishing: Black (Standard)  
Length: 1000mm Width: 31mm Height: 83mm

Luminaire constructed in conformity with Directives 2014/35/EU (LV), 2014/30/EU (EMC), 2009/125/EC (Ecodesign) with Regulations (EC) No 245/2009, (EU) No 347/2010 and (EU) 2015/1428 (for luminaires with fluorescent and metal halide lamps only), 2009/125/EC (Ecodesign) with Regulations (EU) No 1194/2012 and 2015/1428 (for LED luminaires only), 2011/65/EU (RoHS 2) and 2012/19/EU (WEEE).

## Tracks/channels

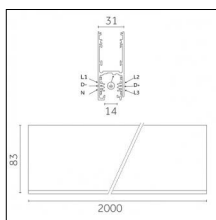
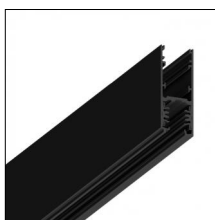

### Code 0.02506.0010 - H Track | Surface/Pendant

Finishing: White (Standard)  
Length: 2000mm Width: 31mm Height: 83mm

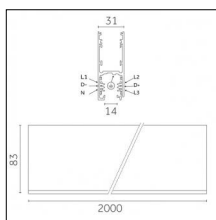

### Code 0.02506.0021 - H Track | Surface/Pendant

Finishing: Black (Standard)  
Length: 2000mm Width: 31mm Height: 83mm

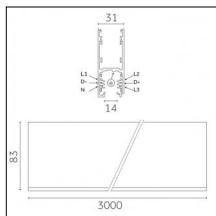

### Code 0.02507.0010 - H Track | Surface/Pendant

Finishing: White (Standard)  
Length: 3000mm Width: 31mm Height: 83mm

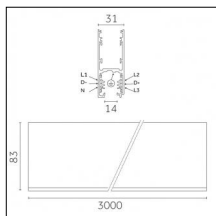

### Code 0.02507.0021 - H Track | Surface/Pendant

Finishing: Black (Standard)  
Length: 3000mm Width: 31mm Height: 83mm

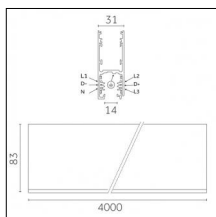

### Code 0.02508.0010 - H Track | Surface/Pendant

Finishing: White (Standard)  
Length: 4000mm Width: 31mm Height: 83mm

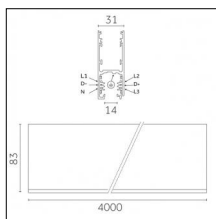

### Code 0.02508.0021 - H Track | Surface/Pendant

Finishing: Black (Standard)  
Length: 4000mm Width: 31mm Height: 83mm

Luminaire constructed in conformity with Directives 2014/35/EU (LV), 2014/30/EU (EMC), 2009/125/EC (Ecodesign) with Regulations (EC) No 245/2009, (EU) No 347/2010 and (EU) 2015/1428 (for luminaires with fluorescent and metal halide lamps only), 2009/125/EC (Ecodesign) with Regulations (EU) No 1194/2012 and 2015/1428 (for LED luminaires only), 2011/65/EU (RoHS 2) and 2012/19/EU (WEEE).

## Driver

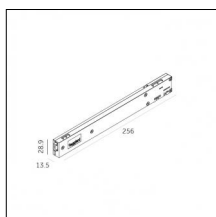

### Code 0.30455.0000 - Driver

Type: On-Off

Watt: 35W - AC Input: 220-244Vac - mA:900mA

Description: Connection options:

1X: 9-13pz

2X: 5-6pz

3X: 3-4pz

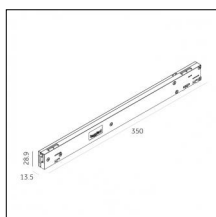

### Code D.30455.0000 - Driver

Type: DALI

Watt: 35W - AC Input: 120-277Vac - mA:900mA

Description: Connection options:

1X: 3-13pz

2X: 2-6pz

3x: 1-4pz

## Accessories

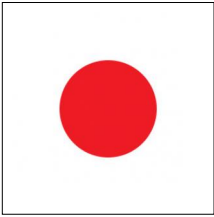

**Code 0.26710.004A - Red glass filter 1 mm**

Type: Optical  
Finishing: Red

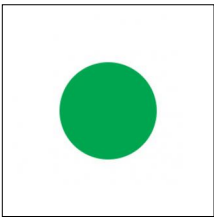

**Code 0.26710.005A - Green glass filter 1 mm**

Type: Optical  
Finishing: Green

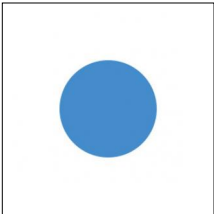

**Code 0.26710.006A - Blue glass filter 1 mm**

Type: Optical  
Finishing: Blue

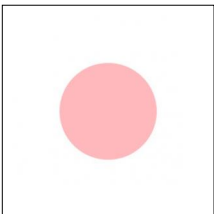

**Code 0.26710.007A - Pink glass filter 1 mm**

Type: Optical  
Finishing: Pink

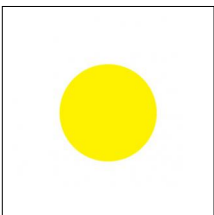

**Code 0.26710.008A - Yellow glass filter 1 mm**

Type: Optical  
Finishing: Yellow

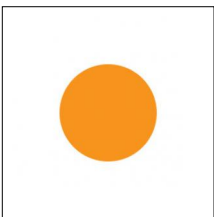

**Code 0.26710.009A - Orange glass filter 1 mm**

Type: Optical  
Finishing: Orange

## Accessories

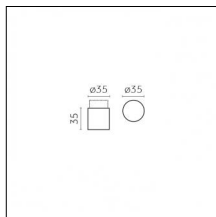

### Code 0.26042.0000 - Cylinder, Full version

Type: Optical  
 Finishing: Without finish / Stainles Steel / Natural aluminium (Standard)  
 Height: 35mm  
 Description: Full version

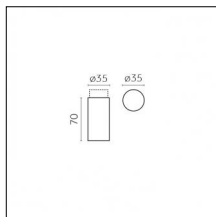

### Code 0.26043.0000 - Cylinder, Full version

Type: Optical  
 Finishing: Without finish / Stainles Steel / Natural aluminium (Standard)  
 Height: 70mm  
 Description: Full version

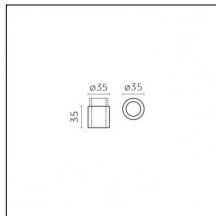

### Code 0.26044.0000 - Cylinder, Hollow version

Type: Optical  
 Finishing: Without finish / Stainles Steel / Natural aluminium (Standard)  
 Height: 35mm  
 Description: Hollow version



### Code 0.26045.0000 - Cylinder, Hollow version

Type: Optical  
 Finishing: Without finish / Stainles Steel / Natural aluminium (Standard)  
 Height: 70mm  
 Description: Hollow version

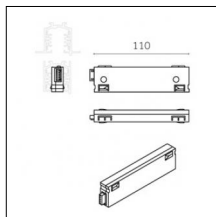

### Code 0.26500.0000 - Standard spacer - 110mm

Type: Structural  
 Finishing: Without finish / Stainles Steel / Natural aluminium (Standard)  
 Length: 110mm

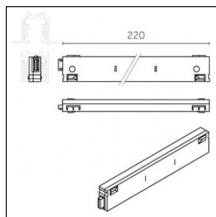

### Code 0.26501.0000 - Standard spacer - 220mm

Type: Structural  
 Finishing: Without finish / Stainles Steel / Natural aluminium (Standard)  
 Length: 220mm

Luminaire constructed in conformity with Directives 2014/35/EU (LV), 2014/30/EU (EMC), 2009/125/EC (Ecodesign) with Regulations (EC) No 245/2009, (EU) No 347/2010 and (EU) 2015/1428 (for luminaires with fluorescent and metal halide lamps only), 2009/125/EC (Ecodesign) with Regulations (EU) No 1194/2012 and 2015/1428 (for LED luminaires only), 2011/65/EU (RoHS 2) and 2012/19/EU (WEEE).

## Accessories

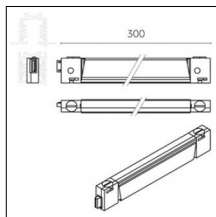

### Code 0.26502.0000 - Customizable spacer - 300mm

Type: Structural  
Finishing: Without finish / Stainles Steel / Natural aluminium (Standard)  
Length: 300mm

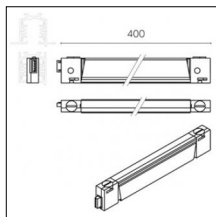

### Code 0.26503.0000 - Customizable spacer - 400mm

Type: Structural  
Finishing: Without finish / Stainles Steel / Natural aluminium (Standard)  
Length: 400mm

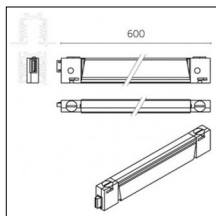

### Code 0.26504.0000 - Customizable spacer - 600mm

Type: Structural  
Finishing: Without finish / Stainles Steel / Natural aluminium (Standard)  
Length: 600mm

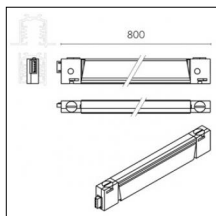

### Code 0.26505.0000 - Customizable spacer - 800mm

Type: Structural  
Finishing: Without finish / Stainles Steel / Natural aluminium (Standard)  
Length: 800mm

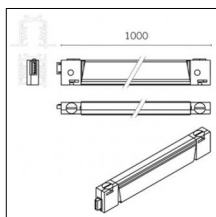

### Code 0.26506.0000 - Customizable spacer - 1000mm

Type: Structural  
Finishing: Without finish / Stainles Steel / Natural aluminium (Standard)  
Length: 1000mm

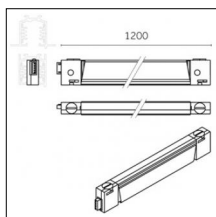

### Code 0.26507.0000 - Customizable spacer - 1200mm

Type: Structural  
Finishing: Without finish / Stainles Steel / Natural aluminium (Standard)  
Length: 1200mm

## Accessories

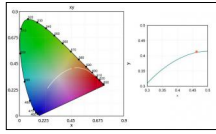
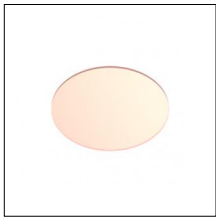

**Code 0.26711.0000 - Selective filter 3000K-2700K**

Type: Optical

Finishing: Without finish / Stainles Steel / Natural aluminium (Standard)

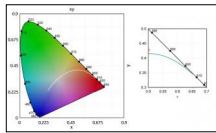
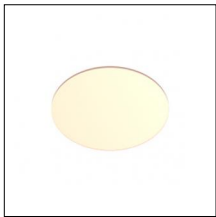

**Code 0.26712.0000 - Selective filter 2700K - 2500K**

Type: Optical

Finishing: Without finish / Stainles Steel / Natural aluminium (Standard)

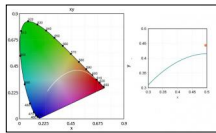
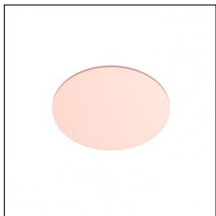

**Code 0.26713.0000 - Selective filter 2700K - 2200K**

Type: Optical

Finishing: Without finish / Stainles Steel / Natural aluminium (Standard)

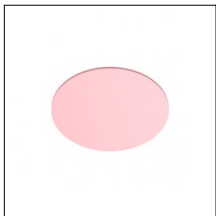

**Code 0.26714.0000 - Selective filter 2700K - 2000K**

Type: Optical

Finishing: Without finish / Stainles Steel / Natural aluminium (Standard)

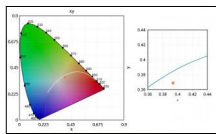
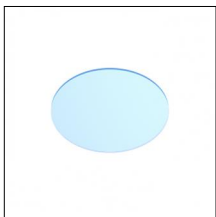

**Code 0.26715.0000 - Selective filter 3000K-3600K**

Type: Optical

Finishing: Without finish / Stainles Steel / Natural aluminium (Standard)

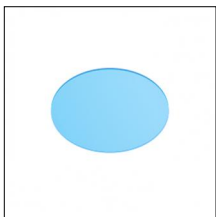

**Code 0.26716.0000 - Selective filter 3000K-4000K**

Type: Optical

Finishing: Without finish / Stainles Steel / Natural aluminium (Standard)

## Accessories

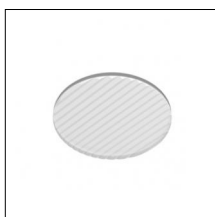

### Code 0.26717.0000 - Elliptical beam lens

Type: Optical

Finishing: Without finish / Stainles Steel / Natural aluminium (Standard)

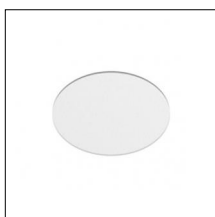

### Code 0.26718.0000 - Opal lens

Type: Optical

Finishing: Without finish / Stainles Steel / Natural aluminium (Standard)

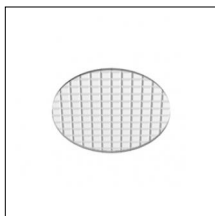

### Code 0.26719.0000 - Diffusive lens

Type: Optical

Finishing: Without finish / Stainles Steel / Natural aluminium (Standard)



Indoor | Pendants | Yori Pendant Ghostrack Ø60mm

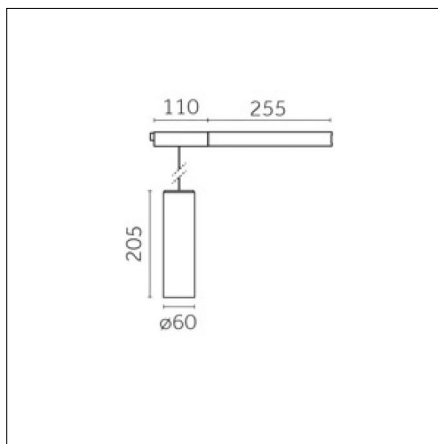

Narrow 12°

12

IP20



Risk 1

850°



### Code 0.LM72B.HQ12

#### Light source features

**Number of light sources:** 1

**Source type:** LED HQ

**Watt:** 9W

**Lm:** 1100lm

**Lm/W:** 122lm/W

**Kelvin/CRI:** 3000K / >90

**SDCM/L90 B10:** < 2 / 50000

#### Electrical features

**Driver included:** YES

**Driver position:** integrated

**Driver type:** On-Off

**Isolation class:** Class I

#### Optical features

**Beam angle:** 12°

**Optical type, adjustability:** Fixed

**Interchangeable optic (IOS):** NO

#### Physical features

**Material:** Die-cast aluminum

**Mounting:** Track, Suspension

**Finishing:** Embossed matt white (Standard)

**Weight:** 0.55Kg

#### Notes:

Cable length 3m

Luminaire constructed in conformity with Directives 2014/35/EU (LV), 2014/30/EU (EMC), 2009/125/EC (Ecodesign) with Regulations (EC) No 245/2009, (EU) No 347/2010 and (EU) 2015/1428 (for luminaires with fluorescent and metal halide lamps only), 2009/125/EC (Ecodesign) with Regulations (EU) No 1194/2012 and 2015/1428 (for LED luminaires only), 2011/65/EU (RoHS 2) and 2012/19/EU (WEEE).

#### Reggiani SPA Illuminazione

Viale Monza, 16 20845 Sovico (MB) Italy  
Tel. (+39) 039 2071.1 fax (+39) 039 2071 999

www.reggiani.net  
contact@reggiani.net

## Photometries



## Tracks/channels

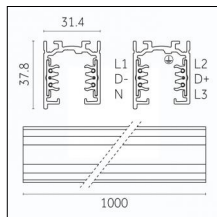
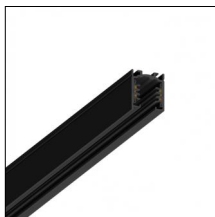

**Code 0.02030.0010 - 3-circuit track surface/pendant**

Finishing: White (Standard)  
Length: 1000mm Width: 31.4mm Height: 37.8mm

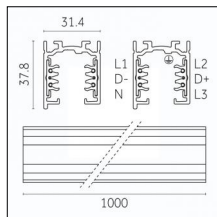

**Code 0.02030.0021 - 3-circuit track surface/pendant**

Finishing: Black (Standard)  
Length: 1000mm Width: 31.4mm Height: 37.8mm

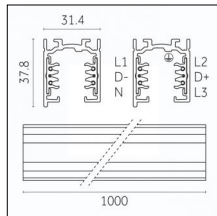

**Code 0.02030.0028 - 3-circuit track surface/pendant**

Finishing: Metallised grey (Standard)  
Length: 1000mm Width: 31.4mm Height: 37.8mm

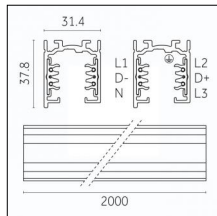

**Code 0.02031.0010 - 3-circuit track surface/pendant**

Finishing: White (Standard)  
Length: 2000mm Width: 31.4mm Height: 37.8mm

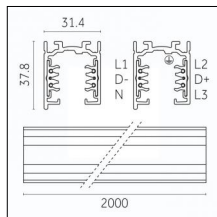
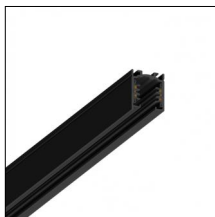

**Code 0.02031.0021 - 3-circuit track surface/pendant**

Finishing: Black (Standard)  
Length: 2000mm Width: 31.4mm Height: 37.8mm

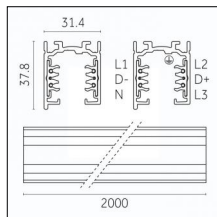

**Code 0.02031.0028 - 3-circuit track surface/pendant**

Finishing: Metallised grey (Standard)  
Length: 2000mm Width: 31.4mm Height: 37.8mm

Luminaire constructed in conformity with Directives 2014/35/EU (LV), 2014/30/EU (EMC), 2009/125/EC (Ecodesign) with Regulations (EC) No 245/2009, (EU) No 347/2010 and (EU) 2015/1428 (for luminaires with fluorescent and metal halide lamps only), 2009/125/EC (Ecodesign) with Regulations (EU) No 1194/2012 and 2015/1428 (for LED luminaires only), 2011/65/EU (RoHS 2) and 2012/19/EU (WEEE).

## Tracks/channels

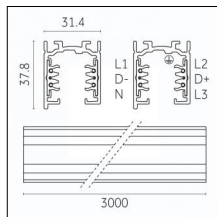
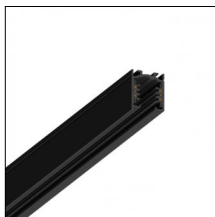

**Code 0.02032.0010 - 3-circuit track surface/pendant**

Finishing: White (Standard)  
Length: 3000mm Width: 31.4mm Height: 37.8mm

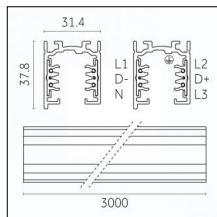

**Code 0.02032.0021 - 3-circuit track surface/pendant**

Finishing: Black (Standard)  
Length: 3000mm Width: 31.4mm Height: 37.8mm

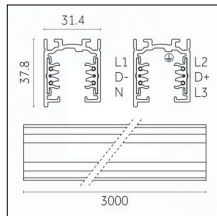

**Code 0.02032.0028 - 3-circuit track surface/pendant**

Finishing: Metallised grey (Standard)  
Length: 3000mm Width: 31.4mm Height: 37.8mm

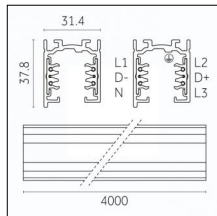

**Code 0.02033.0010 - 3-circuit track surface/pendant**

Finishing: White (Standard)  
Length: 4000mm Width: 31.4mm Height: 37.8mm

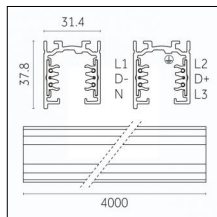

**Code 0.02033.0021 - 3-circuit track surface/pendant**

Finishing: Black (Standard)  
Length: 4000mm Width: 31.4mm Height: 37.8mm

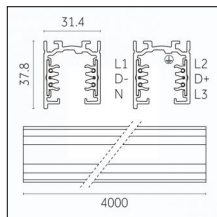

**Code 0.02033.0028 - 3-circuit track surface/pendant**

Finishing: Metallised grey (Standard)  
Length: 4000mm Width: 31.4mm Height: 37.8mm

Luminaire constructed in conformity with Directives 2014/35/EU (LV), 2014/30/EU (EMC), 2009/125/EC (Ecodesign) with Regulations (EC) No 245/2009, (EU) No 347/2010 and (EU) 2015/1428 (for luminaires with fluorescent and metal halide lamps only), 2009/125/EC (Ecodesign) with Regulations (EU) No 1194/2012 and 2015/1428 (for LED luminaires only), 2011/65/EU (RoHS 2) and 2012/19/EU (WEEE).

## Tracks/channels

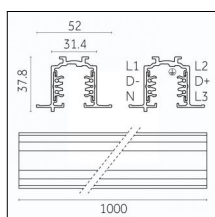

**Code 0.02034.0010 - 3-circuit track recessed**

Finishing: White (Standard)  
Length: 1000mm Width: 52mm Height: 37.8mm

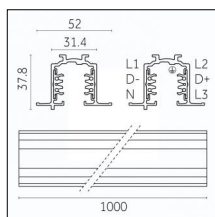
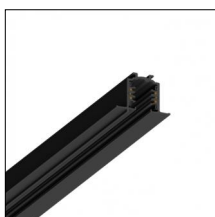

**Code 0.02034.0021 - 3-circuit track recessed**

Finishing: Black (Standard)  
Length: 1000mm Width: 52mm Height: 37.8mm

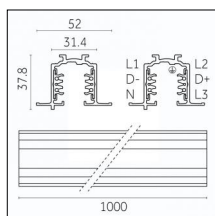

**Code 0.02034.0028 - 3-circuit track recessed**

Finishing: Metallised grey (Standard)  
Length: 1000mm Width: 52mm Height: 37.8mm

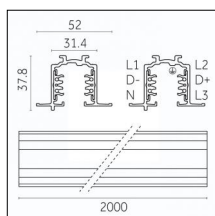

**Code 0.02035.0010 - 3-circuit track recessed**

Finishing: White (Standard)  
Length: 2000mm Width: 52mm Height: 37.8mm

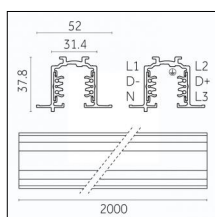

**Code 0.02035.0021 - 3-circuit track recessed**

Finishing: Black (Standard)  
Length: 2000mm Width: 52mm Height: 37.8mm

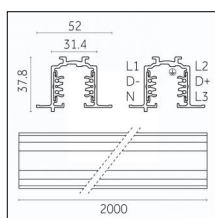

**Code 0.02035.0028 - 3-circuit track recessed**

Finishing: Metallised grey (Standard)  
Length: 2000mm Width: 52mm Height: 37.8mm

Luminaire constructed in conformity with Directives 2014/35/EU (LV), 2014/30/EU (EMC), 2009/125/EC (Ecodesign) with Regulations (EC) No 245/2009, (EU) No 347/2010 and (EU) 2015/1428 (for luminaires with fluorescent and metal halide lamps only), 2009/125/EC (Ecodesign) with Regulations (EU) No 1194/2012 and 2015/1428 (for LED luminaires only), 2011/65/EU (RoHS 2) and 2012/19/EU (WEEE).

## Tracks/channels

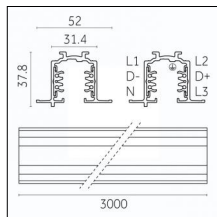

**Code 0.02036.0010 - 3-circuit track recessed**

Finishing: White (Standard)  
Length: 3000mm Width: 52mm Height: 37.8mm

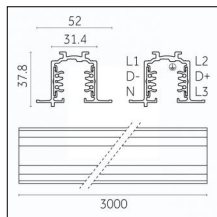

**Code 0.02036.0021 - 3-circuit track recessed**

Finishing: Black (Standard)  
Length: 3000mm Width: 52mm Height: 37.8mm

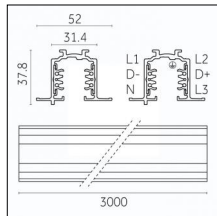

**Code 0.02036.0028 - 3-circuit track recessed**

Finishing: Metallised grey (Standard)  
Length: 3000mm Width: 52mm Height: 37.8mm

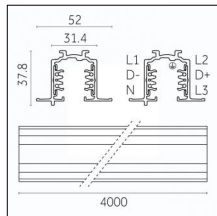

**Code 0.02037.0010 - 3-circuit track recessed**

Finishing: White (Standard)  
Length: 4000mm Width: 52mm Height: 37.8mm

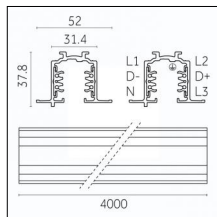

**Code 0.02037.0021 - 3-circuit track recessed**

Finishing: Black (Standard)  
Length: 4000mm Width: 52mm Height: 37.8mm

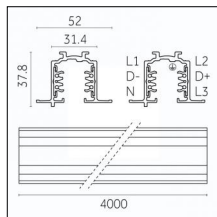

**Code 0.02037.0028 - 3-circuit track recessed**

Finishing: Metallised grey (Standard)  
Length: 4000mm Width: 52mm Height: 37.8mm

Luminaire constructed in conformity with Directives 2014/35/EU (LV), 2014/30/EU (EMC), 2009/125/EC (Ecodesign) with Regulations (EC) No 245/2009, (EU) No 347/2010 and (EU) 2015/1428 (for luminaires with fluorescent and metal halide lamps only), 2009/125/EC (Ecodesign) with Regulations (EU) No 1194/2012 and 2015/1428 (for LED luminaires only), 2011/65/EU (RoHS 2) and 2012/19/EU (WEEE).

## Tracks/channels

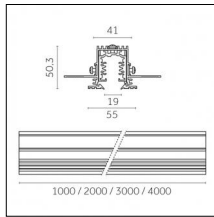

### Code 0.27101.0021 - 3-circuit track Supertrack

Finishing: Black (Standard)  
Length: 1000mm Width: 41mm Height: 50mm

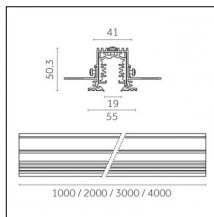

### Code 0.27102.0021 - 3-circuit track Supertrack

Finishing: Black (Standard)  
Length: 2000mm Width: 41mm Height: 50mm

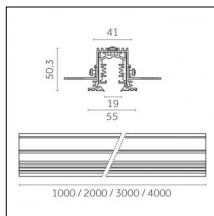

### Code 0.27103.0021 - 3-circuit track Supertrack

Finishing: Black (Standard)  
Length: 3000mm Width: 41mm Height: 50mm

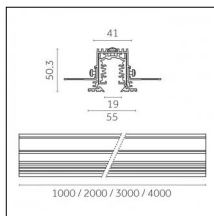

### Code 0.27104.0021 - 3-circuit track Supertrack

Finishing: Black (Standard)  
Length: 4000mm Width: 41mm Height: 50mm

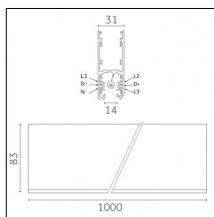
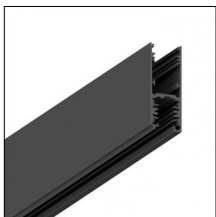

### Code 0.02505.0010 - H Track | Surface/Pendant

Finishing: White (Standard)  
Length: 1000mm Width: 31mm Height: 83mm

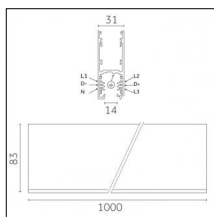
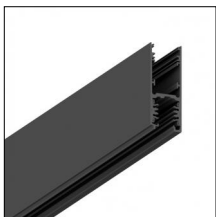

### Code 0.02505.0021 - H Track | Surface/Pendant

Finishing: Black (Standard)  
Length: 1000mm Width: 31mm Height: 83mm

Luminaire constructed in conformity with Directives 2014/35/EU (LV), 2014/30/EU (EMC), 2009/125/EC (Ecodesign) with Regulations (EC) No 245/2009, (EU) No 347/2010 and (EU) 2015/1428 (for luminaires with fluorescent and metal halide lamps only), 2009/125/EC (Ecodesign) with Regulations (EU) No 1194/2012 and 2015/1428 (for LED luminaires only), 2011/65/EU (RoHS 2) and 2012/19/EU (WEEE).

## Tracks/channels

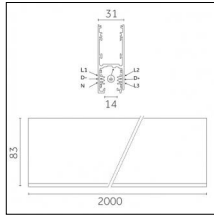
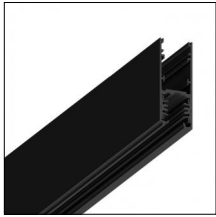

### Code 0.02506.0010 - H Track | Surface/Pendant

Finishing: White (Standard)  
Length: 2000mm Width: 31mm Height: 83mm

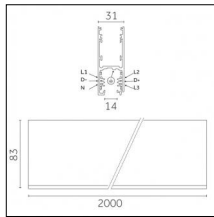

### Code 0.02506.0021 - H Track | Surface/Pendant

Finishing: Black (Standard)  
Length: 2000mm Width: 31mm Height: 83mm

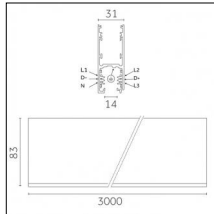

### Code 0.02507.0010 - H Track | Surface/Pendant

Finishing: White (Standard)  
Length: 3000mm Width: 31mm Height: 83mm

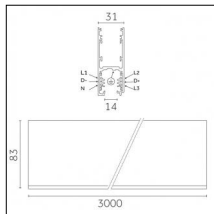

### Code 0.02507.0021 - H Track | Surface/Pendant

Finishing: Black (Standard)  
Length: 3000mm Width: 31mm Height: 83mm

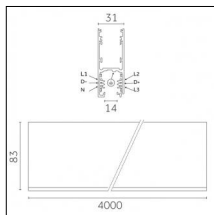

### Code 0.02508.0010 - H Track | Surface/Pendant

Finishing: White (Standard)  
Length: 4000mm Width: 31mm Height: 83mm

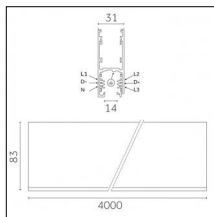
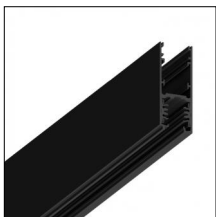

### Code 0.02508.0021 - H Track | Surface/Pendant

Finishing: Black (Standard)  
Length: 4000mm Width: 31mm Height: 83mm



## Optics

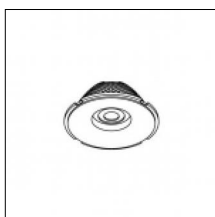

**Code 0.35125.0000 - Ø60mm precision optic 12° - LED**

Finishing:  
Description:



Narrow 12°

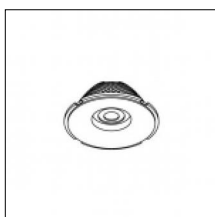

**Code 0.35126.0000 - Ø60mm precision optic 20° - LED**

Finishing:  
Description:



Medium 20°

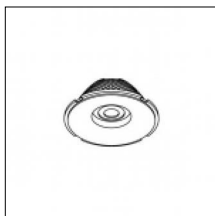

**Code 0.35127.0000 - Ø60mm precision optic 32° - LED**

Finishing:  
Description:



Wide 32°

## Accessories

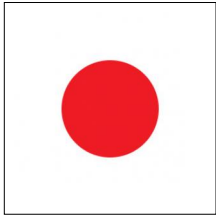

**Code 0.26402.004A - Red glass filter 1 mm**

Type: Optical  
Finishing: Red

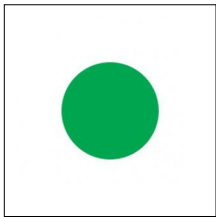

**Code 0.26402.005A - Green glass filter 1 mm**

Type: Optical  
Finishing: Green

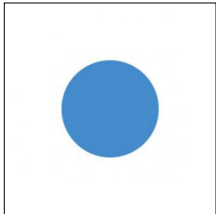

**Code 0.26402.006A - Blue glass filter 1 mm**

Type: Optical  
Finishing: Blue

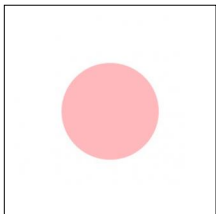

**Code 0.26402.007A - Pink glass filter 1 mm**

Type: Optical  
Finishing: Pink

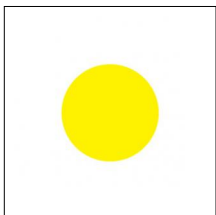

**Code 0.26402.008A - Yellow glass filter 1 mm**

Type: Optical  
Finishing: Yellow

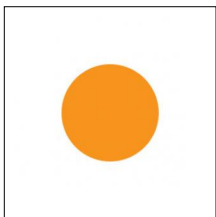

**Code 0.26402.009A - Orange glass filter 1 mm**

Type: Optical  
Finishing: Orange

## Accessories

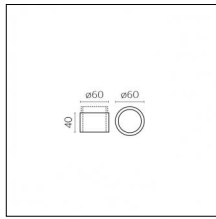

### Code 0.26046.0000 - Cylinder, Hollow version

Type: Optical  
Finishing: Without finish / Stainles Steel / Natural aluminium (Standard)  
Height: 40mm  
Description: Hollow version



### Code 0.26410.0000 - Colored Gel Slides (2 pieces)

Type: Optical  
Finishing: Without finish / Stainles Steel / Natural aluminium (Standard)

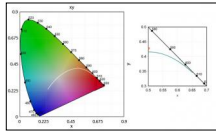
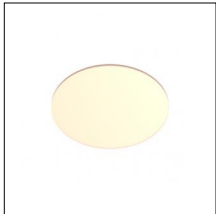

### Code 0.26418.0000 - Selective filter 2700K - 2500K

Type: Optical  
Finishing: Without finish / Stainles Steel / Natural aluminium (Standard)

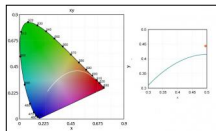
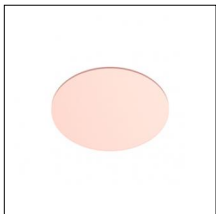

### Code 0.26426.0000 - Selective filter 2700K - 2200K

Type: Optical  
Finishing: Without finish / Stainles Steel / Natural aluminium (Standard)

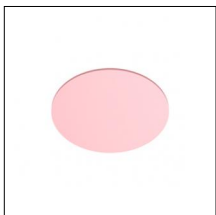

### Code 0.26434.0000 - Selective filter 2700K - 2000K

Type: Optical  
Finishing: Without finish / Stainles Steel / Natural aluminium (Standard)



### Code 0.26442.0000 - Honeycomb dense texture

Type: Optical  
Finishing: Without finish / Stainles Steel / Natural aluminium (Standard)

## Accessories



### Code 0.26450.0000 - Honeycomb wide texture

Type: Optical

Finishing: Without finish / Stainles Steel / Natural aluminium (Standard)

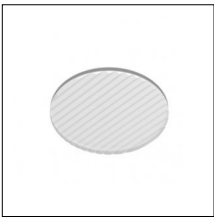

### Code 0.26457.0000 - Ribbed glass

Type: Optical

Finishing: Without finish / Stainles Steel / Natural aluminium (Standard)

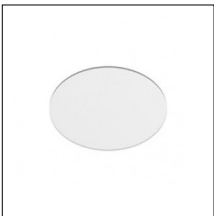

### Code 0.26462.0000 - Opal lens

Type: Optical

Finishing: Without finish / Stainles Steel / Natural aluminium (Standard)

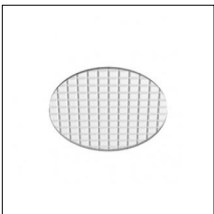

### Code 0.26470.0000 - Diffusive lens

Type: Optical

Finishing: Without finish / Stainles Steel / Natural aluminium (Standard)

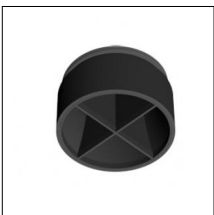

### Code 0.26477.0000 - Cross blade louvre

Type: Optical

Finishing: Without finish / Stainles Steel / Natural aluminium (Standard)

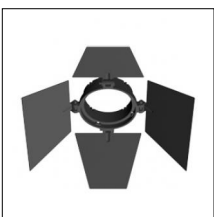

### Code 0.26485.0000 - Barn doors

Type: Optical

Finishing: Without finish / Stainles Steel / Natural aluminium (Standard)

## Accessories

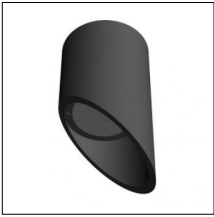

### Code 0.26489.0012 - Cone 45 ° wall washer

Type: Optical  
Finishing: Embossed matt white (Standard)

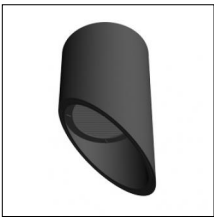

### Code 0.26489.0031 - Cone 45 ° wall washer

Type: Optical  
Finishing: Embossed matt black (Standard)

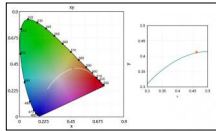
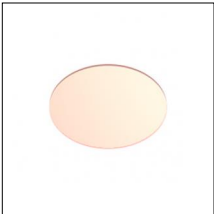

### Code 0.26559.0000 - Selective filter 3000K-2700K

Type: Optical  
Finishing: Without finish / Stainles Steel / Natural aluminium (Standard)

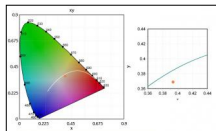
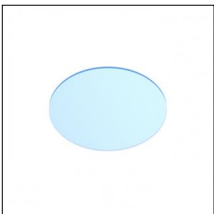

### Code 0.26567.0000 - Selective filter 3000K-3600K

Type: Optical  
Finishing: Without finish / Stainles Steel / Natural aluminium (Standard)

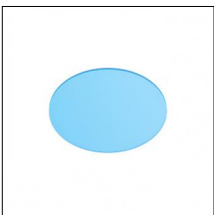

### Code 0.26575.0000 - Selective filter 3000K-4000K

Type: Optical  
Finishing: Without finish / Stainles Steel / Natural aluminium (Standard)

Indoor | Pendants | Yori Pendant Ghostrack Ø60mm

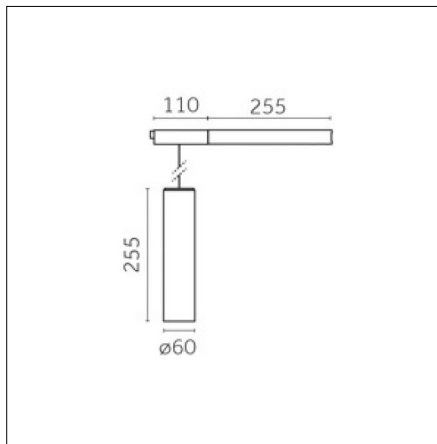

Narrow 12°



IP20



Risk 1

850°



### Code 0.MM72B.DTC0

#### Light source features

**Number of light sources:** 1

**Source type:** LED Warm Dimming DT

**Watt:** 6W

**Lamp note:** Dimming range: from 1700 K to 3000 K

Lumen: from 100 lm to 550 lm

**Lm:** 100lm

**Kelvin/CRI:** / >90

**SDCM/L80 B10:** < 4 / 50000

#### Electrical features

**Driver included:** YES

**Driver position:** integrated

**Driver type:** On-Off

**Isolation class:** Class I

#### Optical features

**Beam angle:** 12°

**Optical type, adjustability:** Fixed

**Interchangeable optic (IOS):** NO

#### Physical features

**Material:** Die-cast aluminum

**Mounting:** Track, Suspension

**Finishing:** Royal matt white

**Weight:** 0.68Kg

#### Notes:

Cable length 3m

Luminaire constructed in conformity with Directives 2014/35/EU (LV), 2014/30/EU (EMC), 2009/125/EC (Ecodesign) with Regulations (EC) No 245/2009, (EU) No 347/2010 and (EU) 2015/1428 (for luminaires with fluorescent and metal halide lamps only), 2009/125/EC (Ecodesign) with Regulations (EU) No 1194/2012 and 2015/1428 (for LED luminaires only), 2011/65/EU (RoHS 2) and 2012/19/EU (WEEE).

#### Reggiani SPA Illuminazione

Viale Monza, 16 20845 Sovico (MB) Italy  
Tel. (+39) 039 2071.1 fax (+39) 039 2071 999

www.reggiani.net  
contact@reggiani.net

## Photometries



## Tracks/channels

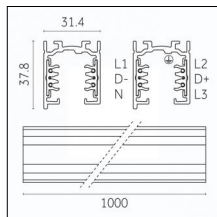

**Code 0.02030.0010 - 3-circuit track surface/pendant**

Finishing: White (Standard)  
Length: 1000mm Width: 31.4mm Height: 37.8mm

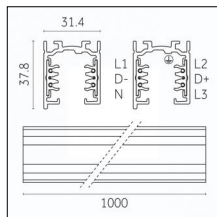
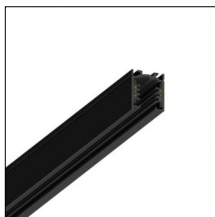

**Code 0.02030.0021 - 3-circuit track surface/pendant**

Finishing: Black (Standard)  
Length: 1000mm Width: 31.4mm Height: 37.8mm

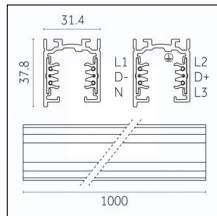
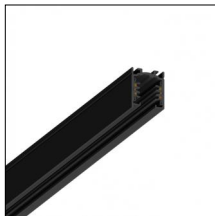

**Code 0.02030.0028 - 3-circuit track surface/pendant**

Finishing: Metallised grey (Standard)  
Length: 1000mm Width: 31.4mm Height: 37.8mm

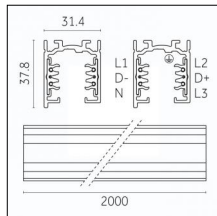

**Code 0.02031.0010 - 3-circuit track surface/pendant**

Finishing: White (Standard)  
Length: 2000mm Width: 31.4mm Height: 37.8mm

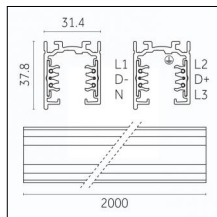

**Code 0.02031.0021 - 3-circuit track surface/pendant**

Finishing: Black (Standard)  
Length: 2000mm Width: 31.4mm Height: 37.8mm

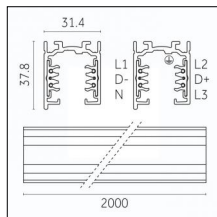

**Code 0.02031.0028 - 3-circuit track surface/pendant**

Finishing: Metallised grey (Standard)  
Length: 2000mm Width: 31.4mm Height: 37.8mm

Luminaire constructed in conformity with Directives 2014/35/EU (LV), 2014/30/EU (EMC), 2009/125/EC (Ecodesign) with Regulations (EC) No 245/2009, (EU) No 347/2010 and (EU) 2015/1428 (for luminaires with fluorescent and metal halide lamps only), 2009/125/EC (Ecodesign) with Regulations (EU) No 1194/2012 and 2015/1428 (for LED luminaires only), 2011/65/EU (RoHS 2) and 2012/19/EU (WEEE).



## Tracks/channels

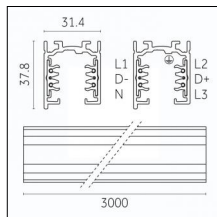

**Code 0.02032.0010 - 3-circuit track surface/pendant**

Finishing: White (Standard)  
Length: 3000mm Width: 31.4mm Height: 37.8mm

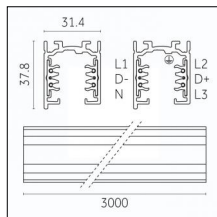

**Code 0.02032.0021 - 3-circuit track surface/pendant**

Finishing: Black (Standard)  
Length: 3000mm Width: 31.4mm Height: 37.8mm

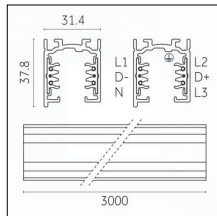

**Code 0.02032.0028 - 3-circuit track surface/pendant**

Finishing: Metallised grey (Standard)  
Length: 3000mm Width: 31.4mm Height: 37.8mm

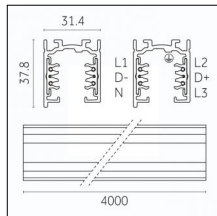

**Code 0.02033.0010 - 3-circuit track surface/pendant**

Finishing: White (Standard)  
Length: 4000mm Width: 31.4mm Height: 37.8mm

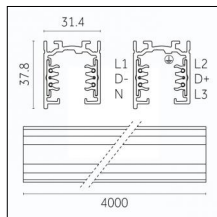

**Code 0.02033.0021 - 3-circuit track surface/pendant**

Finishing: Black (Standard)  
Length: 4000mm Width: 31.4mm Height: 37.8mm

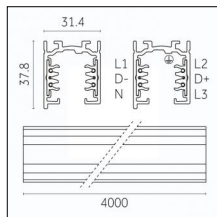

**Code 0.02033.0028 - 3-circuit track surface/pendant**

Finishing: Metallised grey (Standard)  
Length: 4000mm Width: 31.4mm Height: 37.8mm

Luminaire constructed in conformity with Directives 2014/35/EU (LV), 2014/30/EU (EMC), 2009/125/EC (Ecodesign) with Regulations (EC) No 245/2009, (EU) No 347/2010 and (EU) 2015/1428 (for luminaires with fluorescent and metal halide lamps only), 2009/125/EC (Ecodesign) with Regulations (EU) No 1194/2012 and 2015/1428 (for LED luminaires only), 2011/65/EU (RoHS 2) and 2012/19/EU (WEEE).

## Tracks/channels

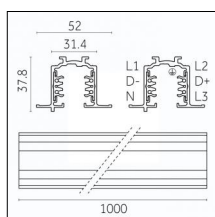

### Code 0.02034.0010 - 3-circuit track recessed

Finishing: White (Standard)  
Length: 1000mm Width: 52mm Height: 37.8mm

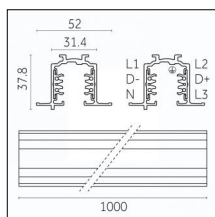

### Code 0.02034.0021 - 3-circuit track recessed

Finishing: Black (Standard)  
Length: 1000mm Width: 52mm Height: 37.8mm

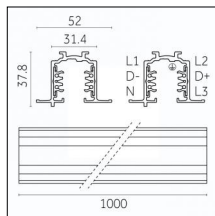

### Code 0.02034.0028 - 3-circuit track recessed

Finishing: Metallised grey (Standard)  
Length: 1000mm Width: 52mm Height: 37.8mm

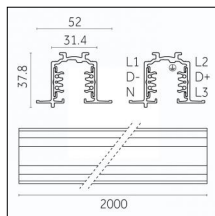

### Code 0.02035.0010 - 3-circuit track recessed

Finishing: White (Standard)  
Length: 2000mm Width: 52mm Height: 37.8mm

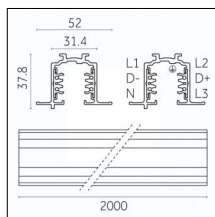

### Code 0.02035.0021 - 3-circuit track recessed

Finishing: Black (Standard)  
Length: 2000mm Width: 52mm Height: 37.8mm

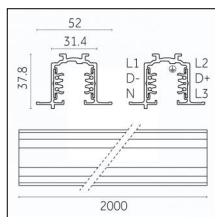

### Code 0.02035.0028 - 3-circuit track recessed

Finishing: Metallised grey (Standard)  
Length: 2000mm Width: 52mm Height: 37.8mm

## Tracks/channels

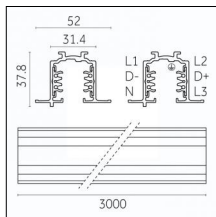

**Code 0.02036.0010 - 3-circuit track recessed**

Finishing: White (Standard)  
Length: 3000mm Width: 52mm Height: 37.8mm

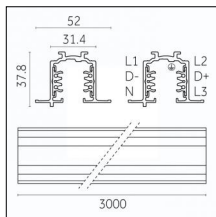

**Code 0.02036.0021 - 3-circuit track recessed**

Finishing: Black (Standard)  
Length: 3000mm Width: 52mm Height: 37.8mm

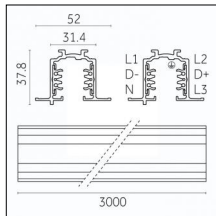

**Code 0.02036.0028 - 3-circuit track recessed**

Finishing: Metallised grey (Standard)  
Length: 3000mm Width: 52mm Height: 37.8mm

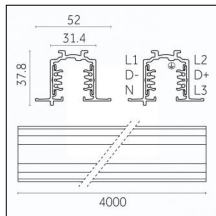

**Code 0.02037.0010 - 3-circuit track recessed**

Finishing: White (Standard)  
Length: 4000mm Width: 52mm Height: 37.8mm

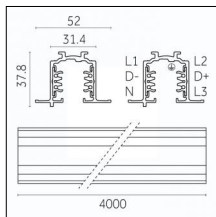

**Code 0.02037.0021 - 3-circuit track recessed**

Finishing: Black (Standard)  
Length: 4000mm Width: 52mm Height: 37.8mm

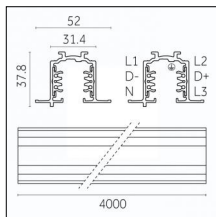

**Code 0.02037.0028 - 3-circuit track recessed**

Finishing: Metallised grey (Standard)  
Length: 4000mm Width: 52mm Height: 37.8mm

## Tracks/channels

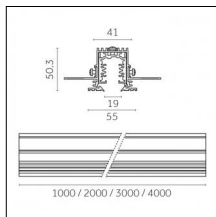

### Code 0.27101.0021 - 3-circuit track Supertrack

Finishing: Black (Standard)  
Length: 1000mm Width: 41mm Height: 50mm

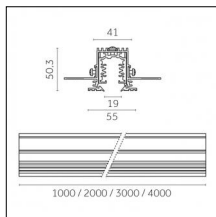

### Code 0.27102.0021 - 3-circuit track Supertrack

Finishing: Black (Standard)  
Length: 2000mm Width: 41mm Height: 50mm

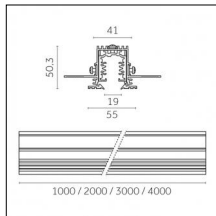

### Code 0.27103.0021 - 3-circuit track Supertrack

Finishing: Black (Standard)  
Length: 3000mm Width: 41mm Height: 50mm

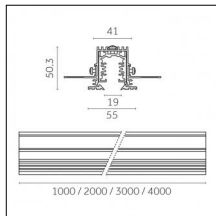

### Code 0.27104.0021 - 3-circuit track Supertrack

Finishing: Black (Standard)  
Length: 4000mm Width: 41mm Height: 50mm

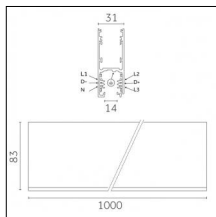
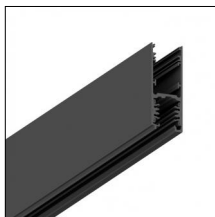

### Code 0.02505.0010 - H Track | Surface/Pendant

Finishing: White (Standard)  
Length: 1000mm Width: 31mm Height: 83mm

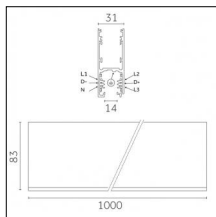
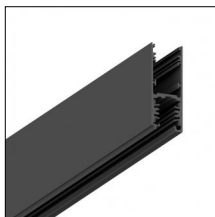

### Code 0.02505.0021 - H Track | Surface/Pendant

Finishing: Black (Standard)  
Length: 1000mm Width: 31mm Height: 83mm

Luminaire constructed in conformity with Directives 2014/35/EU (LV), 2014/30/EU (EMC), 2009/125/EC (Ecodesign) with Regulations (EC) No 245/2009, (EU) No 347/2010 and (EU) 2015/1428 (for luminaires with fluorescent and metal halide lamps only), 2009/125/EC (Ecodesign) with Regulations (EU) No 1194/2012 and 2015/1428 (for LED luminaires only), 2011/65/EU (RoHS 2) and 2012/19/EU (WEEE).

## Tracks/channels

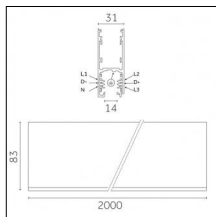

### Code 0.02506.0010 - H Track | Surface/Pendant

Finishing: White (Standard)  
Length: 2000mm Width: 31mm Height: 83mm

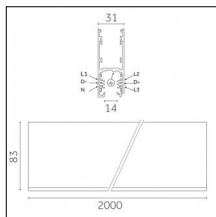

### Code 0.02506.0021 - H Track | Surface/Pendant

Finishing: Black (Standard)  
Length: 2000mm Width: 31mm Height: 83mm

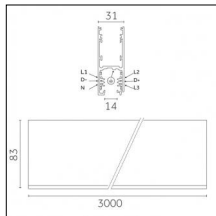

### Code 0.02507.0010 - H Track | Surface/Pendant

Finishing: White (Standard)  
Length: 3000mm Width: 31mm Height: 83mm

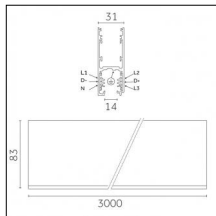

### Code 0.02507.0021 - H Track | Surface/Pendant

Finishing: Black (Standard)  
Length: 3000mm Width: 31mm Height: 83mm

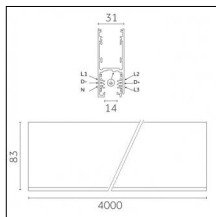

### Code 0.02508.0010 - H Track | Surface/Pendant

Finishing: White (Standard)  
Length: 4000mm Width: 31mm Height: 83mm

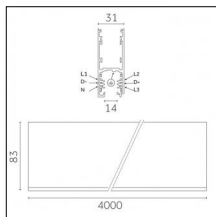

### Code 0.02508.0021 - H Track | Surface/Pendant

Finishing: Black (Standard)  
Length: 4000mm Width: 31mm Height: 83mm

Luminaire constructed in conformity with Directives 2014/35/EU (LV), 2014/30/EU (EMC), 2009/125/EC (Ecodesign) with Regulations (EC) No 245/2009, (EU) No 347/2010 and (EU) 2015/1428 (for luminaires with fluorescent and metal halide lamps only), 2009/125/EC (Ecodesign) with Regulations (EU) No 1194/2012 and 2015/1428 (for LED luminaires only), 2011/65/EU (RoHS 2) and 2012/19/EU (WEEE).

## Optics

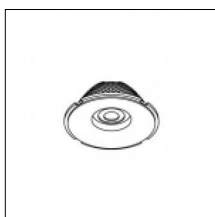

**Code 0.35125.0000 - Ø60mm precision optic 12° - LED**

Finishing:  
Description:



Narrow 12°

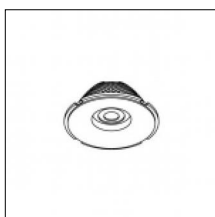

**Code 0.35126.0000 - Ø60mm precision optic 20° - LED**

Finishing:  
Description:



Medium 20°

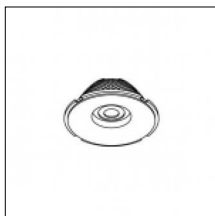

**Code 0.35127.0000 - Ø60mm precision optic 32° - LED**

Finishing:  
Description:



Wide 32°

## Accessories

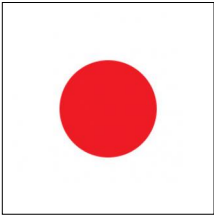

**Code 0.26402.004A - Red glass filter 1 mm**

Type: Optical  
Finishing: Red

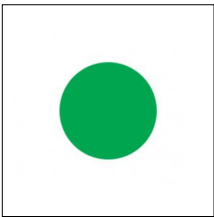

**Code 0.26402.005A - Green glass filter 1 mm**

Type: Optical  
Finishing: Green

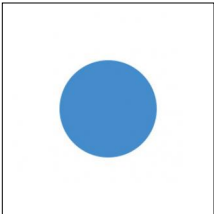

**Code 0.26402.006A - Blue glass filter 1 mm**

Type: Optical  
Finishing: Blue

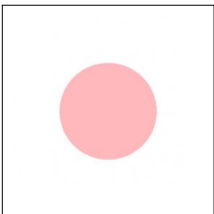

**Code 0.26402.007A - Pink glass filter 1 mm**

Type: Optical  
Finishing: Pink

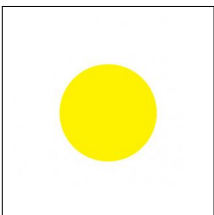

**Code 0.26402.008A - Yellow glass filter 1 mm**

Type: Optical  
Finishing: Yellow

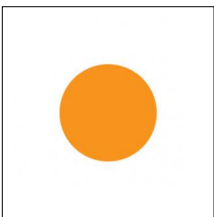

**Code 0.26402.009A - Orange glass filter 1 mm**

Type: Optical  
Finishing: Orange

## Accessories

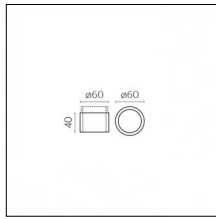

### Code 0.26046.0000 - Cylinder, Hollow version

Type: Optical  
 Finishing: Without finish / Stainles Steel / Natural aluminium (Standard)  
 Height: 40mm  
 Description: Hollow version



### Code 0.26410.0000 - Colored Gel Slides (2 pieces)

Type: Optical  
 Finishing: Without finish / Stainles Steel / Natural aluminium (Standard)

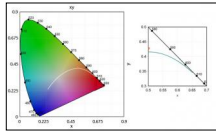
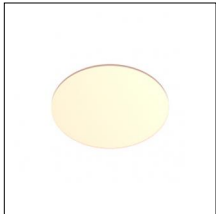

### Code 0.26418.0000 - Selective filter 2700K - 2500K

Type: Optical  
 Finishing: Without finish / Stainles Steel / Natural aluminium (Standard)

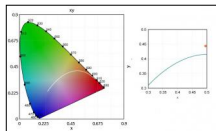
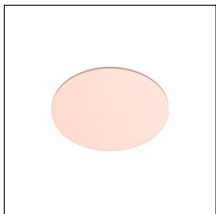

### Code 0.26426.0000 - Selective filter 2700K - 2200K

Type: Optical  
 Finishing: Without finish / Stainles Steel / Natural aluminium (Standard)

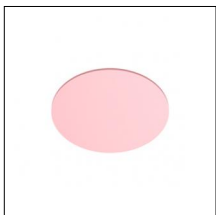

### Code 0.26434.0000 - Selective filter 2700K - 2000K

Type: Optical  
 Finishing: Without finish / Stainles Steel / Natural aluminium (Standard)



### Code 0.26442.0000 - Honeycomb dense texture

Type: Optical  
 Finishing: Without finish / Stainles Steel / Natural aluminium (Standard)



## Accessories



### Code 0.26450.0000 - Honeycomb wide texture

Type: Optical

Finishing: Without finish / Stainles Steel / Natural aluminium (Standard)

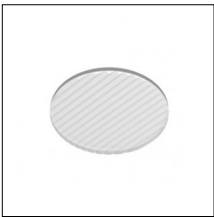

### Code 0.26457.0000 - Ribbed glass

Type: Optical

Finishing: Without finish / Stainles Steel / Natural aluminium (Standard)

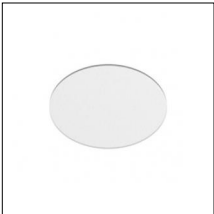

### Code 0.26462.0000 - Opal lens

Type: Optical

Finishing: Without finish / Stainles Steel / Natural aluminium (Standard)

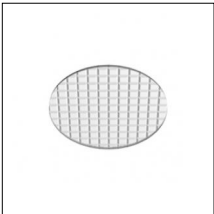

### Code 0.26470.0000 - Diffusive lens

Type: Optical

Finishing: Without finish / Stainles Steel / Natural aluminium (Standard)

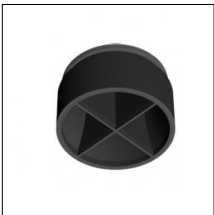

### Code 0.26477.0000 - Cross blade louvre

Type: Optical

Finishing: Without finish / Stainles Steel / Natural aluminium (Standard)

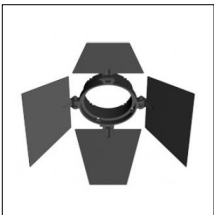

### Code 0.26485.0000 - Barn doors

Type: Optical

Finishing: Without finish / Stainles Steel / Natural aluminium (Standard)

## Accessories

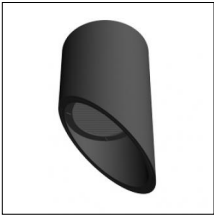

### Code 0.26489.0012 - Cone 45 ° wall washer

Type: Optical  
Finishing: Embossed matt white (Standard)



### Code 0.26489.0031 - Cone 45 ° wall washer

Type: Optical  
Finishing: Embossed matt black (Standard)

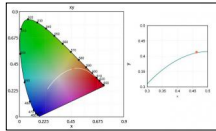

### Code 0.26559.0000 - Selective filter 3000K-2700K

Type: Optical  
Finishing: Without finish / Stainles Steel / Natural aluminium (Standard)

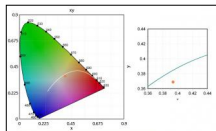
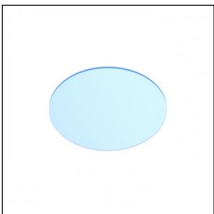

### Code 0.26567.0000 - Selective filter 3000K-3600K

Type: Optical  
Finishing: Without finish / Stainles Steel / Natural aluminium (Standard)

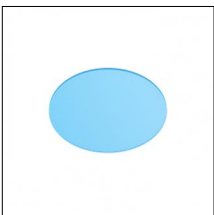

### Code 0.26575.0000 - Selective filter 3000K-4000K

Type: Optical  
Finishing: Without finish / Stainles Steel / Natural aluminium (Standard)

Indoor | Pendants | Yori Pendant Ghostrack Ø60mm

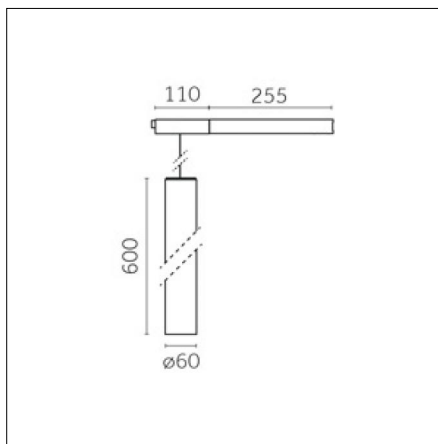

Narrow 12°



IP20



Risk 1

850°



### Code 0.MM73B.DTC0

#### Light source features

**Number of light sources:** 1

**Source type:** LED Warm Dimming DT

**Watt:** 12W

**Lamp note:** Dimming range: from 2000 K to 3000 K

Lumen: from 105 lm to 1000 lm

**Kelvin/CRI:** / >95

**SDCM/L70 B10:** < 4 / 50000

#### Electrical features

**Driver included:** YES

**Driver position:** integrated

**Driver type:** On-Off

**Isolation class:** Class I

#### Optical features

**Beam angle:** 12°

**Optical type, adjustability:** Fixed

**Interchangeable optic (IOS):** NO

#### Physical features

**Material:** Die-cast aluminum

**Mounting:** Track, Suspension

**Finishing:** Royal matt white

**Weight:** 1.62Kg

#### Notes:

Cable length 3m

Luminaire constructed in conformity with Directives 2014/35/EU (LV), 2014/30/EU (EMC), 2009/125/EC (Ecodesign) with Regulations (EC) No 245/2009, (EU) No 347/2010 and (EU) 2015/1428 (for luminaires with fluorescent and metal halide lamps only), 2009/125/EC (Ecodesign) with Regulations (EU) No 1194/2012 and 2015/1428 (for LED luminaires only), 2011/65/EU (RoHS 2) and 2012/19/EU (WEEE).

#### Reggiani SPA Illuminazione

Viale Monza, 16 20845 Sovico (MB) Italy  
Tel. (+39) 039 2071.1 fax (+39) 039 2071 999

www.reggiani.net  
contact@reggiani.net

## Photometries



## Tracks/channels

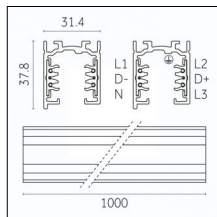
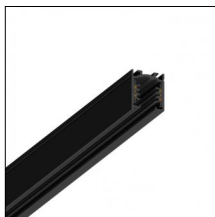

**Code 0.02030.0010 - 3-circuit track surface/pendant**

Finishing: White (Standard)  
Length: 1000mm Width: 31.4mm Height: 37.8mm

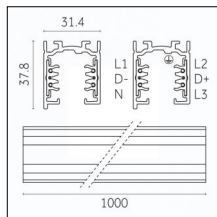

**Code 0.02030.0021 - 3-circuit track surface/pendant**

Finishing: Black (Standard)  
Length: 1000mm Width: 31.4mm Height: 37.8mm

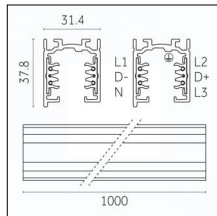
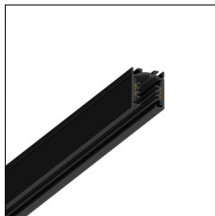

**Code 0.02030.0028 - 3-circuit track surface/pendant**

Finishing: Metallised grey (Standard)  
Length: 1000mm Width: 31.4mm Height: 37.8mm

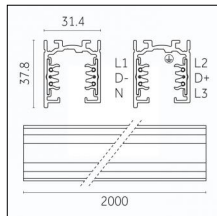

**Code 0.02031.0010 - 3-circuit track surface/pendant**

Finishing: White (Standard)  
Length: 2000mm Width: 31.4mm Height: 37.8mm

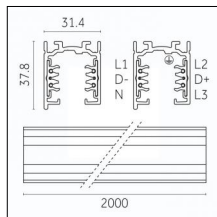

**Code 0.02031.0021 - 3-circuit track surface/pendant**

Finishing: Black (Standard)  
Length: 2000mm Width: 31.4mm Height: 37.8mm

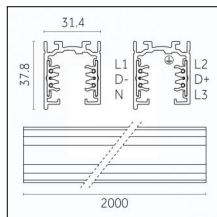

**Code 0.02031.0028 - 3-circuit track surface/pendant**

Finishing: Metallised grey (Standard)  
Length: 2000mm Width: 31.4mm Height: 37.8mm

Luminaire constructed in conformity with Directives 2014/35/EU (LV), 2014/30/EU (EMC), 2009/125/EC (Ecodesign) with Regulations (EC) No 245/2009, (EU) No 347/2010 and (EU) 2015/1428 (for luminaires with fluorescent and metal halide lamps only), 2009/125/EC (Ecodesign) with Regulations (EU) No 1194/2012 and 2015/1428 (for LED luminaires only), 2011/65/EU (RoHS 2) and 2012/19/EU (WEEE).

## Tracks/channels

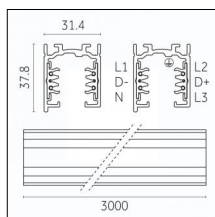

### Code 0.02032.0010 - 3-circuit track surface/pendant

Finishing: White (Standard)  
Length: 3000mm Width: 31.4mm Height: 37.8mm

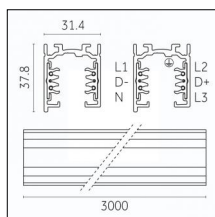

### Code 0.02032.0021 - 3-circuit track surface/pendant

Finishing: Black (Standard)  
Length: 3000mm Width: 31.4mm Height: 37.8mm

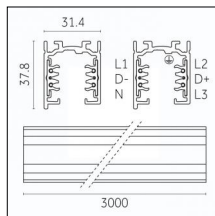

### Code 0.02032.0028 - 3-circuit track surface/pendant

Finishing: Metallised grey (Standard)  
Length: 3000mm Width: 31.4mm Height: 37.8mm

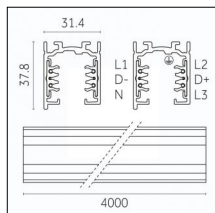

### Code 0.02033.0010 - 3-circuit track surface/pendant

Finishing: White (Standard)  
Length: 4000mm Width: 31.4mm Height: 37.8mm

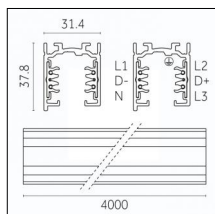
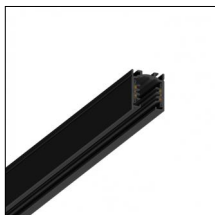

### Code 0.02033.0021 - 3-circuit track surface/pendant

Finishing: Black (Standard)  
Length: 4000mm Width: 31.4mm Height: 37.8mm

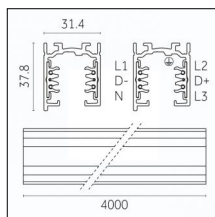

### Code 0.02033.0028 - 3-circuit track surface/pendant

Finishing: Metallised grey (Standard)  
Length: 4000mm Width: 31.4mm Height: 37.8mm

Luminaire constructed in conformity with Directives 2014/35/EU (LV), 2014/30/EU (EMC), 2009/125/EC (Ecodesign) with Regulations (EC) No 245/2009, (EU) No 347/2010 and (EU) 2015/1428 (for luminaires with fluorescent and metal halide lamps only), 2009/125/EC (Ecodesign) with Regulations (EU) No 1194/2012 and 2015/1428 (for LED luminaires only), 2011/65/EU (RoHS 2) and 2012/19/EU (WEEE).

## Tracks/channels

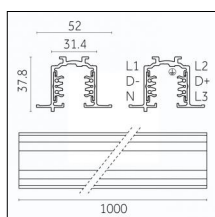
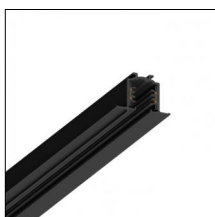

### Code 0.02034.0010 - 3-circuit track recessed

Finishing: White (Standard)  
Length: 1000mm Width: 52mm Height: 37.8mm

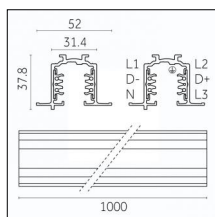

### Code 0.02034.0021 - 3-circuit track recessed

Finishing: Black (Standard)  
Length: 1000mm Width: 52mm Height: 37.8mm

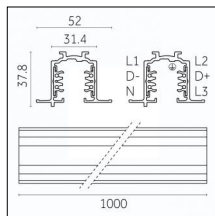

### Code 0.02034.0028 - 3-circuit track recessed

Finishing: Metallised grey (Standard)  
Length: 1000mm Width: 52mm Height: 37.8mm

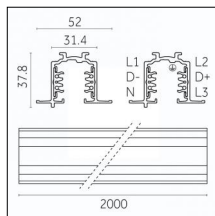

### Code 0.02035.0010 - 3-circuit track recessed

Finishing: White (Standard)  
Length: 2000mm Width: 52mm Height: 37.8mm

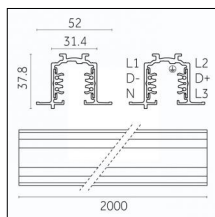

### Code 0.02035.0021 - 3-circuit track recessed

Finishing: Black (Standard)  
Length: 2000mm Width: 52mm Height: 37.8mm

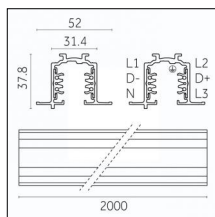

### Code 0.02035.0028 - 3-circuit track recessed

Finishing: Metallised grey (Standard)  
Length: 2000mm Width: 52mm Height: 37.8mm

Luminaire constructed in conformity with Directives 2014/35/EU (LV), 2014/30/EU (EMC), 2009/125/EC (Ecodesign) with Regulations (EC) No 245/2009, (EU) No 347/2010 and (EU) 2015/1428 (for luminaires with fluorescent and metal halide lamps only), 2009/125/EC (Ecodesign) with Regulations (EU) No 1194/2012 and 2015/1428 (for LED luminaires only), 2011/65/EU (RoHS 2) and 2012/19/EU (WEEE).

## Tracks/channels

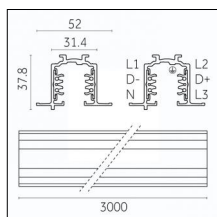

**Code 0.02036.0010 - 3-circuit track recessed**

Finishing: White (Standard)  
Length: 3000mm Width: 52mm Height: 37.8mm

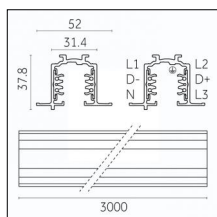

**Code 0.02036.0021 - 3-circuit track recessed**

Finishing: Black (Standard)  
Length: 3000mm Width: 52mm Height: 37.8mm

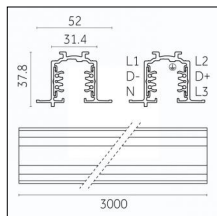

**Code 0.02036.0028 - 3-circuit track recessed**

Finishing: Metallised grey (Standard)  
Length: 3000mm Width: 52mm Height: 37.8mm

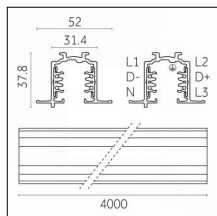

**Code 0.02037.0010 - 3-circuit track recessed**

Finishing: White (Standard)  
Length: 4000mm Width: 52mm Height: 37.8mm

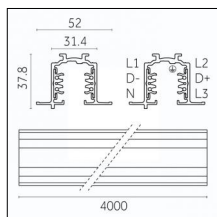

**Code 0.02037.0021 - 3-circuit track recessed**

Finishing: Black (Standard)  
Length: 4000mm Width: 52mm Height: 37.8mm

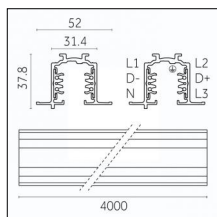

**Code 0.02037.0028 - 3-circuit track recessed**

Finishing: Metallised grey (Standard)  
Length: 4000mm Width: 52mm Height: 37.8mm

Luminaire constructed in conformity with Directives 2014/35/EU (LV), 2014/30/EU (EMC), 2009/125/EC (Ecodesign) with Regulations (EC) No 245/2009, (EU) No 347/2010 and (EU) 2015/1428 (for luminaires with fluorescent and metal halide lamps only), 2009/125/EC (Ecodesign) with Regulations (EU) No 1194/2012 and 2015/1428 (for LED luminaires only), 2011/65/EU (RoHS 2) and 2012/19/EU (WEEE).



## Tracks/channels

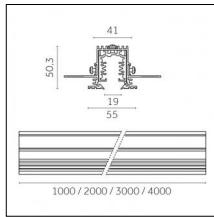

### Code 0.27101.0021 - 3-circuit track Supertrack

Finishing: Black (Standard)  
Length: 1000mm Width: 41mm Height: 50mm

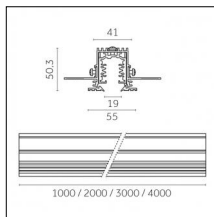

### Code 0.27102.0021 - 3-circuit track Supertrack

Finishing: Black (Standard)  
Length: 2000mm Width: 41mm Height: 50mm

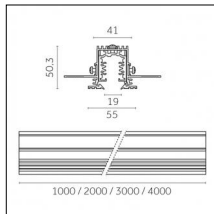

### Code 0.27103.0021 - 3-circuit track Supertrack

Finishing: Black (Standard)  
Length: 3000mm Width: 41mm Height: 50mm

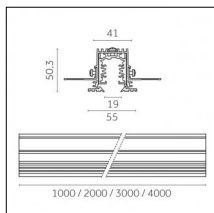

### Code 0.27104.0021 - 3-circuit track Supertrack

Finishing: Black (Standard)  
Length: 4000mm Width: 41mm Height: 50mm

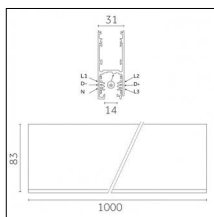
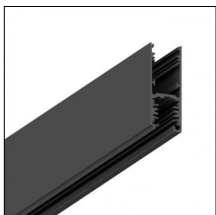

### Code 0.02505.0010 - H Track | Surface/Pendant

Finishing: White (Standard)  
Length: 1000mm Width: 31mm Height: 83mm

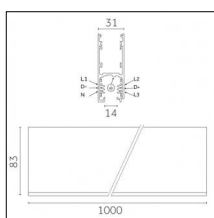
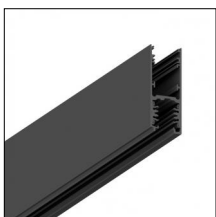

### Code 0.02505.0021 - H Track | Surface/Pendant

Finishing: Black (Standard)  
Length: 1000mm Width: 31mm Height: 83mm

Luminaire constructed in conformity with Directives 2014/35/EU (LV), 2014/30/EU (EMC), 2009/125/EC (Ecodesign) with Regulations (EC) No 245/2009, (EU) No 347/2010 and (EU) 2015/1428 (for luminaires with fluorescent and metal halide lamps only), 2009/125/EC (Ecodesign) with Regulations (EU) No 1194/2012 and 2015/1428 (for LED luminaires only), 2011/65/EU (RoHS 2) and 2012/19/EU (WEEE).

## Tracks/channels

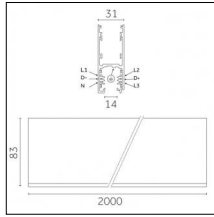
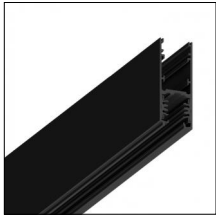

### Code 0.02506.0010 - H Track | Surface/Pendant

Finishing: White (Standard)  
Length: 2000mm Width: 31mm Height: 83mm

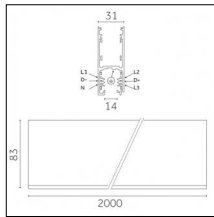

### Code 0.02506.0021 - H Track | Surface/Pendant

Finishing: Black (Standard)  
Length: 2000mm Width: 31mm Height: 83mm

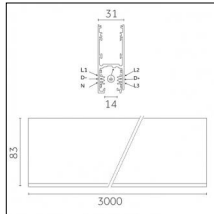

### Code 0.02507.0010 - H Track | Surface/Pendant

Finishing: White (Standard)  
Length: 3000mm Width: 31mm Height: 83mm

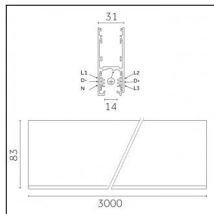

### Code 0.02507.0021 - H Track | Surface/Pendant

Finishing: Black (Standard)  
Length: 3000mm Width: 31mm Height: 83mm

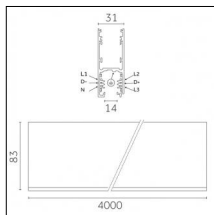

### Code 0.02508.0010 - H Track | Surface/Pendant

Finishing: White (Standard)  
Length: 4000mm Width: 31mm Height: 83mm

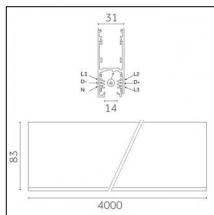

### Code 0.02508.0021 - H Track | Surface/Pendant

Finishing: Black (Standard)  
Length: 4000mm Width: 31mm Height: 83mm

Luminaire constructed in conformity with Directives 2014/35/EU (LV), 2014/30/EU (EMC), 2009/125/EC (Ecodesign) with Regulations (EC) No 245/2009, (EU) No 347/2010 and (EU) 2015/1428 (for luminaires with fluorescent and metal halide lamps only), 2009/125/EC (Ecodesign) with Regulations (EU) No 1194/2012 and 2015/1428 (for LED luminaires only), 2011/65/EU (RoHS 2) and 2012/19/EU (WEEE).

## Optics

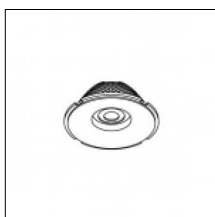

**Code 0.35125.0000 - Ø60mm precision optic 12° - LED**

Finishing:  
Description:



Narrow 12°

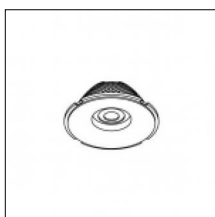

**Code 0.35126.0000 - Ø60mm precision optic 20° - LED**

Finishing:  
Description:



Medium 20°

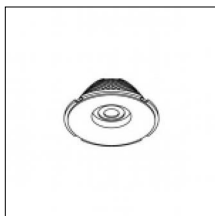

**Code 0.35127.0000 - Ø60mm precision optic 32° - LED**

Finishing:  
Description:



Wide 32°

## Accessories

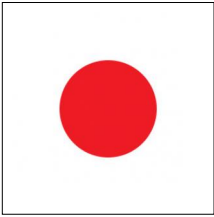

**Code 0.26402.004A - Red glass filter 1 mm**

Type: Optical  
Finishing: Red

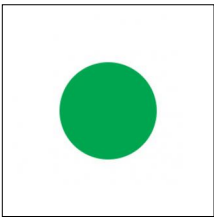

**Code 0.26402.005A - Green glass filter 1 mm**

Type: Optical  
Finishing: Green

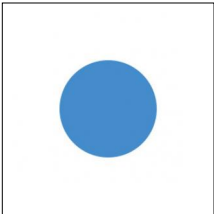

**Code 0.26402.006A - Blue glass filter 1 mm**

Type: Optical  
Finishing: Blue

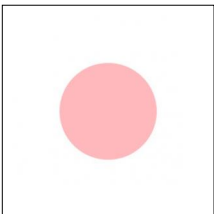

**Code 0.26402.007A - Pink glass filter 1 mm**

Type: Optical  
Finishing: Pink

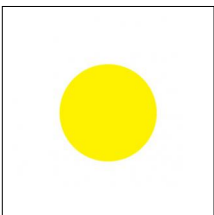

**Code 0.26402.008A - Yellow glass filter 1 mm**

Type: Optical  
Finishing: Yellow

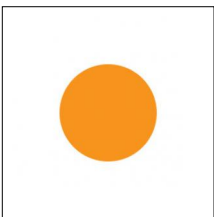

**Code 0.26402.009A - Orange glass filter 1 mm**

Type: Optical  
Finishing: Orange

## Accessories

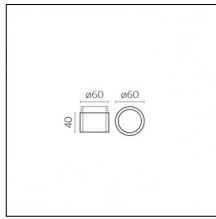

### Code 0.26046.0000 - Cylinder, Hollow version

Type: Optical  
Finishing: Without finish / Stainles Steel / Natural aluminium (Standard)  
Height: 40mm  
Description: Hollow version



### Code 0.26410.0000 - Colored Gel Slides (2 pieces)

Type: Optical  
Finishing: Without finish / Stainles Steel / Natural aluminium (Standard)

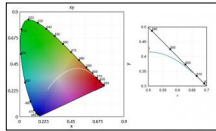
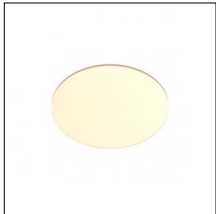

### Code 0.26418.0000 - Selective filter 2700K - 2500K

Type: Optical  
Finishing: Without finish / Stainles Steel / Natural aluminium (Standard)

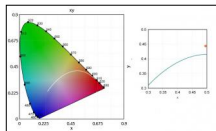
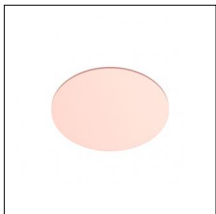

### Code 0.26426.0000 - Selective filter 2700K - 2200K

Type: Optical  
Finishing: Without finish / Stainles Steel / Natural aluminium (Standard)

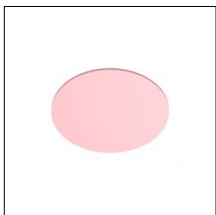

### Code 0.26434.0000 - Selective filter 2700K - 2000K

Type: Optical  
Finishing: Without finish / Stainles Steel / Natural aluminium (Standard)



### Code 0.26442.0000 - Honeycomb dense texture

Type: Optical  
Finishing: Without finish / Stainles Steel / Natural aluminium (Standard)

## Accessories



### Code 0.26450.0000 - Honeycomb wide texture

Type: Optical

Finishing: Without finish / Stainles Steel / Natural aluminium (Standard)

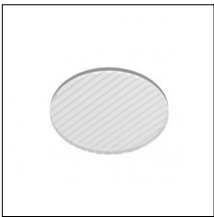

### Code 0.26457.0000 - Ribbed glass

Type: Optical

Finishing: Without finish / Stainles Steel / Natural aluminium (Standard)

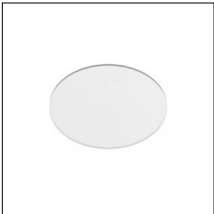

### Code 0.26462.0000 - Opal lens

Type: Optical

Finishing: Without finish / Stainles Steel / Natural aluminium (Standard)

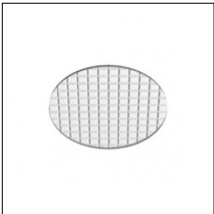

### Code 0.26470.0000 - Diffusive lens

Type: Optical

Finishing: Without finish / Stainles Steel / Natural aluminium (Standard)

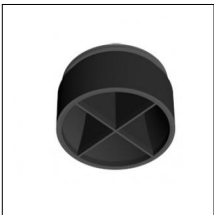

### Code 0.26477.0000 - Cross blade louvre

Type: Optical

Finishing: Without finish / Stainles Steel / Natural aluminium (Standard)

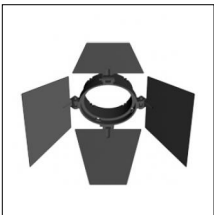

### Code 0.26485.0000 - Barn doors

Type: Optical

Finishing: Without finish / Stainles Steel / Natural aluminium (Standard)

## Accessories

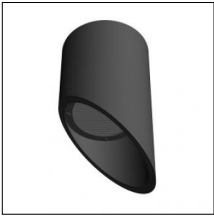

### Code 0.26489.0012 - Cone 45 ° wall washer

Type: Optical  
Finishing: Embossed matt white (Standard)

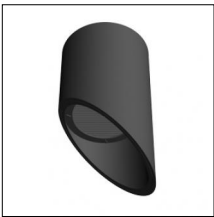

### Code 0.26489.0031 - Cone 45 ° wall washer

Type: Optical  
Finishing: Embossed matt black (Standard)

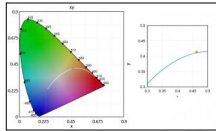
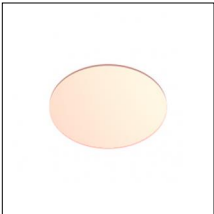

### Code 0.26559.0000 - Selective filter 3000K-2700K

Type: Optical  
Finishing: Without finish / Stainles Steel / Natural aluminium (Standard)

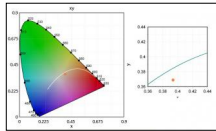
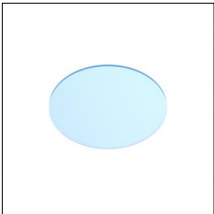

### Code 0.26567.0000 - Selective filter 3000K-3600K

Type: Optical  
Finishing: Without finish / Stainles Steel / Natural aluminium (Standard)

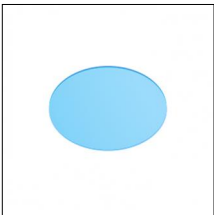

### Code 0.26575.0000 - Selective filter 3000K-4000K

Type: Optical  
Finishing: Without finish / Stainles Steel / Natural aluminium (Standard)

Indoor | Pendants | Yori Pendant Ghostrack Ø95mm

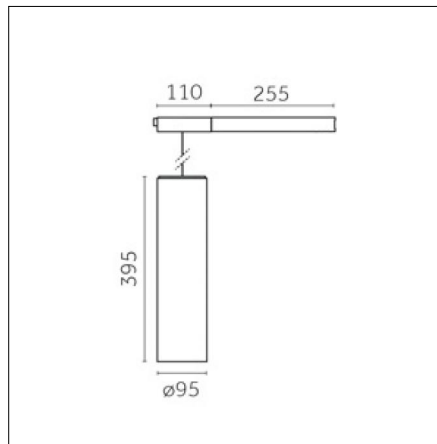

Narrow 12°

31

IP20



Risk 1

850°



**Code 0.NM76B.HQ31**

### Light source features

**Number of light sources:** 1

**Source type:** LED HQ

**Watt:** 24W

**Lm:** 2860lm

**Lm/W:** 119lm/W

**Kelvin/CRI:** 3000K / >90

**SDCM/L90 B10:** < 2 / 50000

### Electrical features

**Driver included:** YES

**Driver position:** integrated

**Driver type:** On-Off

**Isolation class:** Class I

### Optical features

**Beam angle:** 12°

**Optical type, adjustability:** Fixed

**Interchangeable optic (IOS):** NO

### Physical features

**Material:** Die-cast aluminum

**Mounting:** Track, Suspension

**Finishing:** Embossed matt black (Standard)

**Weight:** 2Kg

### Notes:

Cable length 3m

Luminaire constructed in conformity with Directives 2014/35/EU (LV), 2014/30/EU (EMC), 2009/125/EC (Ecodesign) with Regulations (EC) No 245/2009, (EU) No 347/2010 and (EU) 2015/1428 (for luminaires with fluorescent and metal halide lamps only), 2009/125/EC (Ecodesign) with Regulations (EU) No 1194/2012 and 2015/1428 (for LED luminaires only), 2011/65/EU (RoHS 2) and 2012/19/EU (WEEE).

**Reggiani SPA Illuminazione**

Viale Monza, 16 20845 Sovico (MB) Italy  
Tel. (+39) 039 2071.1 fax (+39) 039 2071 999

www.reggiani.net  
contact@reggiani.net



## Photometries



## Tracks/channels

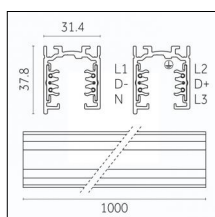
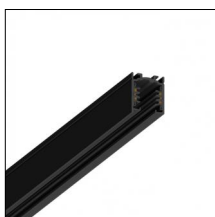

### Code 0.02030.0010 - 3-circuit track surface/pendant

Finishing: White (Standard)  
Length: 1000mm Width: 31.4mm Height: 37.8mm

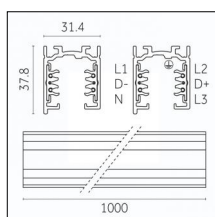

### Code 0.02030.0021 - 3-circuit track surface/pendant

Finishing: Black (Standard)  
Length: 1000mm Width: 31.4mm Height: 37.8mm

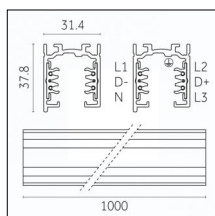
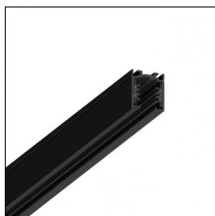

### Code 0.02030.0028 - 3-circuit track surface/pendant

Finishing: Metallised grey (Standard)  
Length: 1000mm Width: 31.4mm Height: 37.8mm

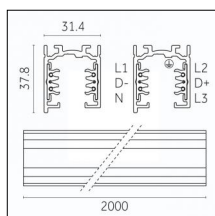
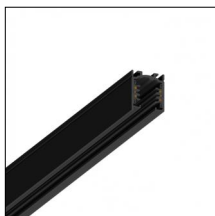

### Code 0.02031.0010 - 3-circuit track surface/pendant

Finishing: White (Standard)  
Length: 2000mm Width: 31.4mm Height: 37.8mm

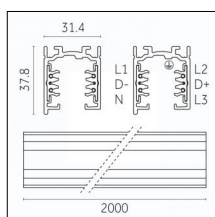

### Code 0.02031.0021 - 3-circuit track surface/pendant

Finishing: Black (Standard)  
Length: 2000mm Width: 31.4mm Height: 37.8mm

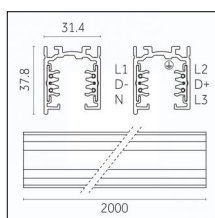
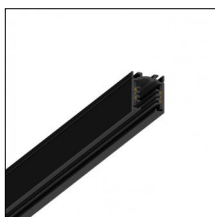

### Code 0.02031.0028 - 3-circuit track surface/pendant

Finishing: Metallised grey (Standard)  
Length: 2000mm Width: 31.4mm Height: 37.8mm

## Tracks/channels

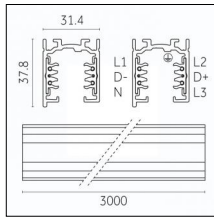

### Code 0.02032.0010 - 3-circuit track surface/pendant

Finishing: White (Standard)  
Length: 3000mm Width: 31.4mm Height: 37.8mm

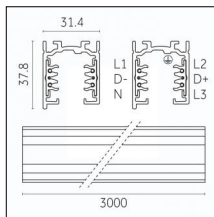

### Code 0.02032.0021 - 3-circuit track surface/pendant

Finishing: Black (Standard)  
Length: 3000mm Width: 31.4mm Height: 37.8mm

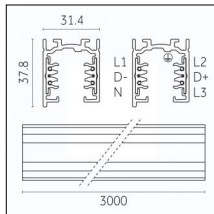

### Code 0.02032.0028 - 3-circuit track surface/pendant

Finishing: Metallised grey (Standard)  
Length: 3000mm Width: 31.4mm Height: 37.8mm

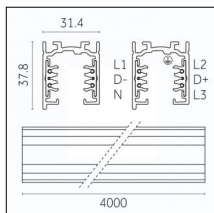

### Code 0.02033.0010 - 3-circuit track surface/pendant

Finishing: White (Standard)  
Length: 4000mm Width: 31.4mm Height: 37.8mm

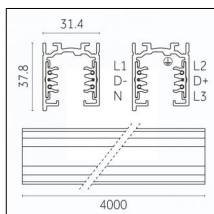
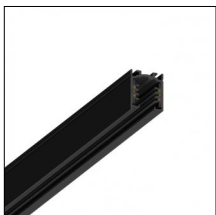

### Code 0.02033.0021 - 3-circuit track surface/pendant

Finishing: Black (Standard)  
Length: 4000mm Width: 31.4mm Height: 37.8mm

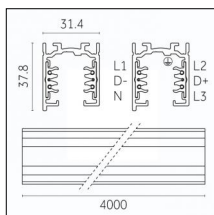

### Code 0.02033.0028 - 3-circuit track surface/pendant

Finishing: Metallised grey (Standard)  
Length: 4000mm Width: 31.4mm Height: 37.8mm

Luminaire constructed in conformity with Directives 2014/35/EU (LV), 2014/30/EU (EMC), 2009/125/EC (Ecodesign) with Regulations (EC) No 245/2009, (EU) No 347/2010 and (EU) 2015/1428 (for luminaires with fluorescent and metal halide lamps only), 2009/125/EC (Ecodesign) with Regulations (EU) No 1194/2012 and 2015/1428 (for LED luminaires only), 2011/65/EU (RoHS 2) and 2012/19/EU (WEEE).

## Tracks/channels

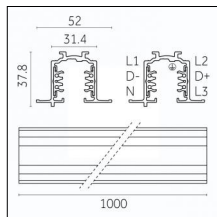

**Code 0.02034.0010 - 3-circuit track recessed**

Finishing: White (Standard)  
Length: 1000mm Width: 52mm Height: 37.8mm

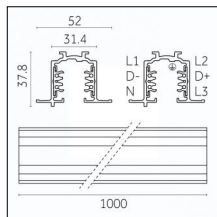

**Code 0.02034.0021 - 3-circuit track recessed**

Finishing: Black (Standard)  
Length: 1000mm Width: 52mm Height: 37.8mm

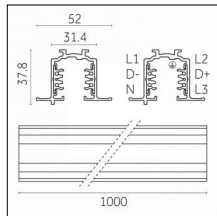

**Code 0.02034.0028 - 3-circuit track recessed**

Finishing: Metallised grey (Standard)  
Length: 1000mm Width: 52mm Height: 37.8mm

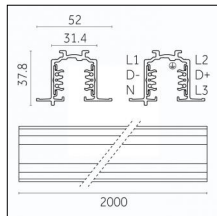

**Code 0.02035.0010 - 3-circuit track recessed**

Finishing: White (Standard)  
Length: 2000mm Width: 52mm Height: 37.8mm

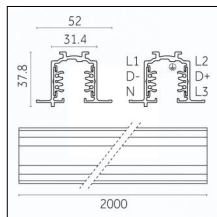

**Code 0.02035.0021 - 3-circuit track recessed**

Finishing: Black (Standard)  
Length: 2000mm Width: 52mm Height: 37.8mm

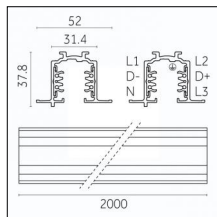

**Code 0.02035.0028 - 3-circuit track recessed**

Finishing: Metallised grey (Standard)  
Length: 2000mm Width: 52mm Height: 37.8mm

Luminaire constructed in conformity with Directives 2014/35/EU (LV), 2014/30/EU (EMC), 2009/125/EC (Ecodesign) with Regulations (EC) No 245/2009, (EU) No 347/2010 and (EU) 2015/1428 (for luminaires with fluorescent and metal halide lamps only), 2009/125/EC (Ecodesign) with Regulations (EU) No 1194/2012 and 2015/1428 (for LED luminaires only), 2011/65/EU (RoHS 2) and 2012/19/EU (WEEE).

## Tracks/channels

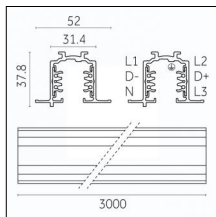

**Code 0.02036.0010 - 3-circuit track recessed**

Finishing: White (Standard)  
Length: 3000mm Width: 52mm Height: 37.8mm

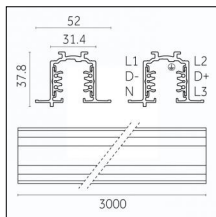

**Code 0.02036.0021 - 3-circuit track recessed**

Finishing: Black (Standard)  
Length: 3000mm Width: 52mm Height: 37.8mm

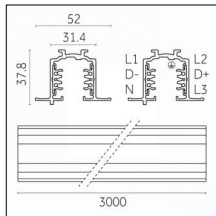

**Code 0.02036.0028 - 3-circuit track recessed**

Finishing: Metallised grey (Standard)  
Length: 3000mm Width: 52mm Height: 37.8mm

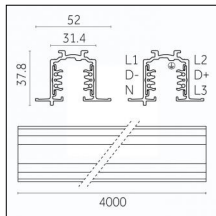

**Code 0.02037.0010 - 3-circuit track recessed**

Finishing: White (Standard)  
Length: 4000mm Width: 52mm Height: 37.8mm

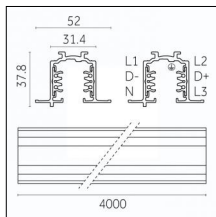

**Code 0.02037.0021 - 3-circuit track recessed**

Finishing: Black (Standard)  
Length: 4000mm Width: 52mm Height: 37.8mm

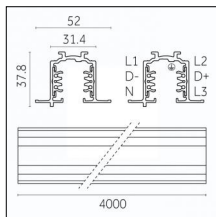

**Code 0.02037.0028 - 3-circuit track recessed**

Finishing: Metallised grey (Standard)  
Length: 4000mm Width: 52mm Height: 37.8mm

Luminaire constructed in conformity with Directives 2014/35/EU (LV), 2014/30/EU (EMC), 2009/125/EC (Ecodesign) with Regulations (EC) No 245/2009, (EU) No 347/2010 and (EU) 2015/1428 (for luminaires with fluorescent and metal halide lamps only), 2009/125/EC (Ecodesign) with Regulations (EU) No 1194/2012 and 2015/1428 (for LED luminaires only), 2011/65/EU (RoHS 2) and 2012/19/EU (WEEE).

## Tracks/channels

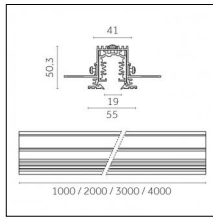

### Code 0.27101.0021 - 3-circuit track Supertrack

Finishing: Black (Standard)  
Length: 1000mm Width: 41mm Height: 50mm

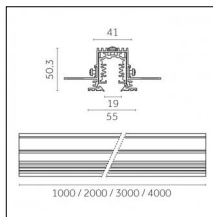

### Code 0.27102.0021 - 3-circuit track Supertrack

Finishing: Black (Standard)  
Length: 2000mm Width: 41mm Height: 50mm

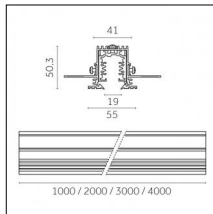

### Code 0.27103.0021 - 3-circuit track Supertrack

Finishing: Black (Standard)  
Length: 3000mm Width: 41mm Height: 50mm

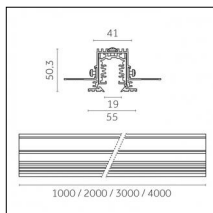

### Code 0.27104.0021 - 3-circuit track Supertrack

Finishing: Black (Standard)  
Length: 4000mm Width: 41mm Height: 50mm

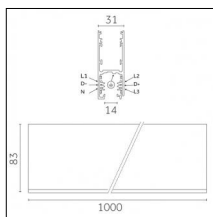
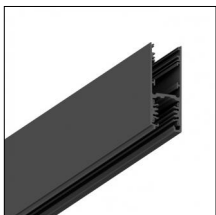

### Code 0.02505.0010 - H Track | Surface/Pendant

Finishing: White (Standard)  
Length: 1000mm Width: 31mm Height: 83mm

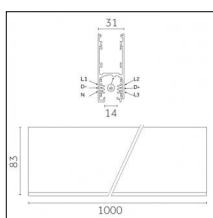
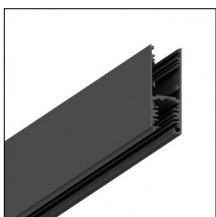

### Code 0.02505.0021 - H Track | Surface/Pendant

Finishing: Black (Standard)  
Length: 1000mm Width: 31mm Height: 83mm

Luminaire constructed in conformity with Directives 2014/35/EU (LV), 2014/30/EU (EMC), 2009/125/EC (Ecodesign) with Regulations (EC) No 245/2009, (EU) No 347/2010 and (EU) 2015/1428 (for luminaires with fluorescent and metal halide lamps only), 2009/125/EC (Ecodesign) with Regulations (EU) No 1194/2012 and 2015/1428 (for LED luminaires only), 2011/65/EU (RoHS 2) and 2012/19/EU (WEEE).

## Tracks/channels

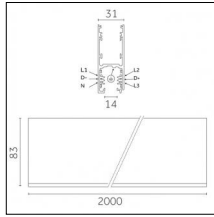
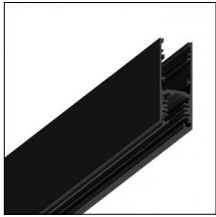

### Code 0.02506.0010 - H Track | Surface/Pendant

Finishing: White (Standard)  
Length: 2000mm Width: 31mm Height: 83mm

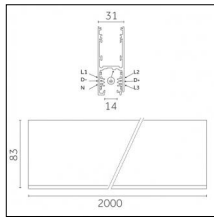

### Code 0.02506.0021 - H Track | Surface/Pendant

Finishing: Black (Standard)  
Length: 2000mm Width: 31mm Height: 83mm

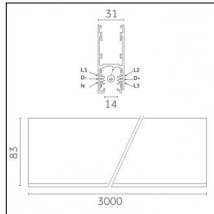

### Code 0.02507.0010 - H Track | Surface/Pendant

Finishing: White (Standard)  
Length: 3000mm Width: 31mm Height: 83mm

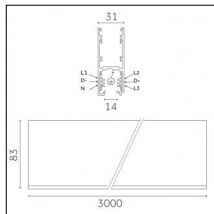

### Code 0.02507.0021 - H Track | Surface/Pendant

Finishing: Black (Standard)  
Length: 3000mm Width: 31mm Height: 83mm

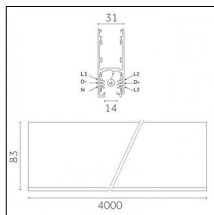

### Code 0.02508.0010 - H Track | Surface/Pendant

Finishing: White (Standard)  
Length: 4000mm Width: 31mm Height: 83mm

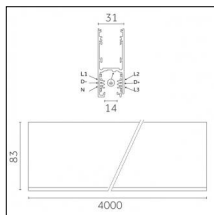

### Code 0.02508.0021 - H Track | Surface/Pendant

Finishing: Black (Standard)  
Length: 4000mm Width: 31mm Height: 83mm

Luminaire constructed in conformity with Directives 2014/35/EU (LV), 2014/30/EU (EMC), 2009/125/EC (Ecodesign) with Regulations (EC) No 245/2009, (EU) No 347/2010 and (EU) 2015/1428 (for luminaires with fluorescent and metal halide lamps only), 2009/125/EC (Ecodesign) with Regulations (EU) No 1194/2012 and 2015/1428 (for LED luminaires only), 2011/65/EU (RoHS 2) and 2012/19/EU (WEEE).

## Optics

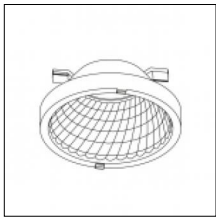

**Code 0.35037.0000 - LL7 - Very wide beam (53°) - LED**

Finishing:  
Description:

Wide Wide

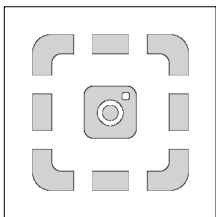

**Code 0.35038.0000 - LL7 - Very wide beam (53°) - LED**

Finishing:  
Description:

Very wide Very wide

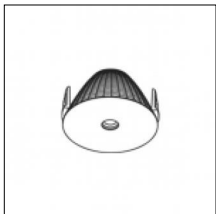

**Code 0.35135.0000 - Ø95mm precision optic 12° - LED**

Finishing:  
Description:



Narrow 12°

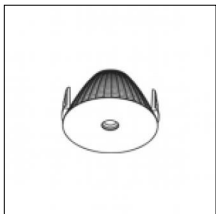

**Code 0.35136.0000 - Ø95mm precision optic 24° - LED**

Finishing:  
Description:



Medium 24°



## Accessories

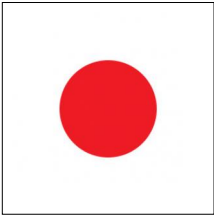

**Code 0.26406.004A - Red glass filter 1 mm**

Type: Optical  
Finishing: Red

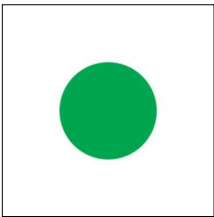

**Code 0.26406.005A - Green glass filter 1 mm**

Type: Optical  
Finishing: Green

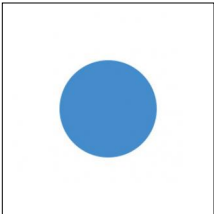

**Code 0.26406.006A - Blue glass filter 1 mm**

Type: Optical  
Finishing: Blue

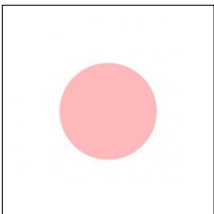

**Code 0.26406.007A - Pink glass filter 1 mm**

Type: Optical  
Finishing: Pink

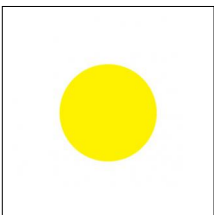

**Code 0.26406.008A - Yellow glass filter 1 mm**

Type: Optical  
Finishing: Yellow

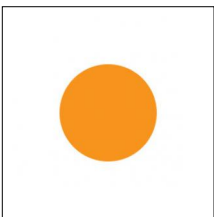

**Code 0.26406.009A - Orange glass filter 1 mm**

Type: Optical  
Finishing: Orange

## Accessories

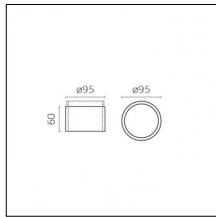

### Code 0.26047.0000 - Cylinder, Hollow version

Type: Optical  
 Finishing: Without finish / Stainles Steel / Natural aluminium (Standard)  
 Height: 60mm  
 Description: Hollow version



### Code 0.26414.0000 - Colored Gel Slides (2 pieces)

Type: Optical  
 Finishing: Without finish / Stainles Steel / Natural aluminium (Standard)

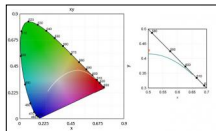
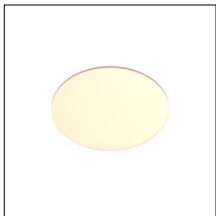

### Code 0.26422.0000 - Selective filter 2700K - 2500K

Type: Optical  
 Finishing: Without finish / Stainles Steel / Natural aluminium (Standard)

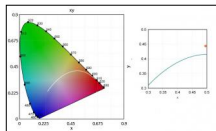
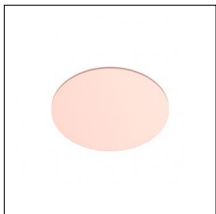

### Code 0.26430.0000 - Selective filter 2700K - 2200K

Type: Optical  
 Finishing: Without finish / Stainles Steel / Natural aluminium (Standard)

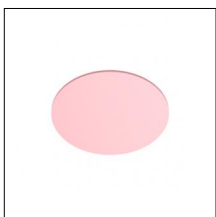

### Code 0.26438.0000 - Selective filter 2700K - 2000K

Type: Optical  
 Finishing: Without finish / Stainles Steel / Natural aluminium (Standard)

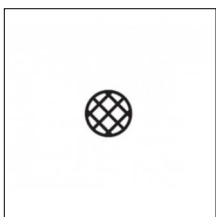

### Code 0.26446.0000 - Honeycomb dense texture

Type: Optical  
 Finishing: Without finish / Stainles Steel / Natural aluminium (Standard)

## Accessories

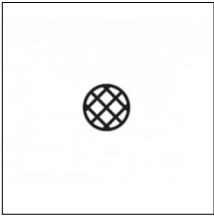

### Code 0.26454.0000 - Honeycomb wide texture

Type: Optical

Finishing: Without finish / Stainles Steel / Natural aluminium (Standard)

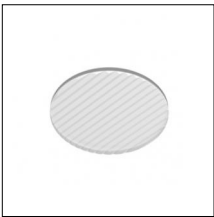

### Code 0.26459.0000 - Ribbed glass

Type: Optical

Finishing: Without finish / Stainles Steel / Natural aluminium (Standard)

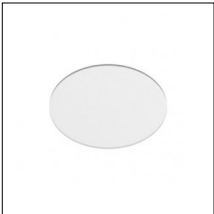

### Code 0.26466.0000 - Opal lens

Type: Optical

Finishing: Without finish / Stainles Steel / Natural aluminium (Standard)

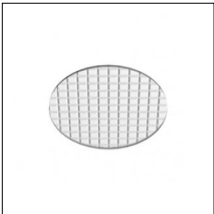

### Code 0.26474.0000 - Diffusive lens

Type: Optical

Finishing: Without finish / Stainles Steel / Natural aluminium (Standard)

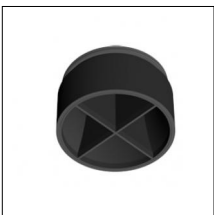

### Code 0.26479.0000 - Cross blade louver

Type: Optical

Finishing: Without finish / Stainles Steel / Natural aluminium (Standard)

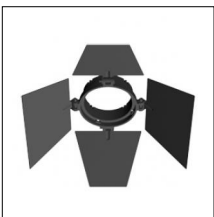

### Code 0.26487.0000 - Barn doors

Type: Optical

Finishing: Without finish / Stainles Steel / Natural aluminium (Standard)

## Accessories



### Code 0.26491.0012 - Cone 45 ° wall washer

Type: Optical  
Finishing: Embossed matt white (Standard)



### Code 0.26491.0031 - Cone 45 ° wall washer

Type: Optical  
Finishing: Embossed matt black (Standard)

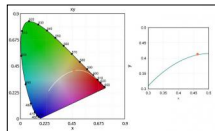
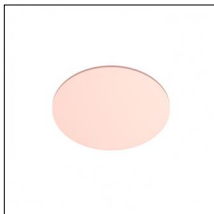

### Code 0.26563.0000 - Selective filter 3000K-2700K

Type: Optical  
Finishing: Without finish / Stainles Steel / Natural aluminium (Standard)

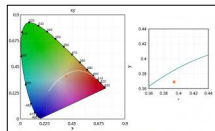
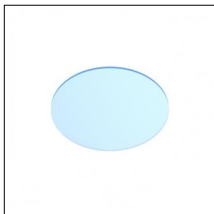

### Code 0.26571.0000 - Selective filter 3000K-3600K

Type: Optical  
Finishing: Without finish / Stainles Steel / Natural aluminium (Standard)

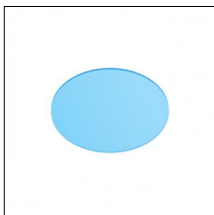

### Code 0.26579.0000 - Selective filter 3000K-4000K

Type: Optical  
Finishing: Without finish / Stainles Steel / Natural aluminium (Standard)

Indoor | Pendants | Yori Pendant Ghostrack Ø95mm

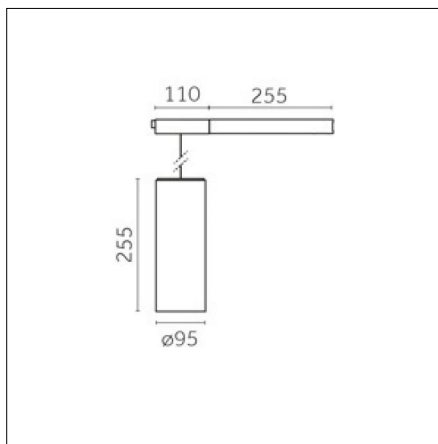

Narrow 12°



IP20



Risk 1

850°



**Code 0.NM73B.HQM0**

### Light source features

**Number of light sources:** 1

**Source type:** LED HQ

**Watt:** 12W

**Lm:** 1533lm

**Lm/W:** 128lm/W

**Kelvin/CRI:** 3000K / >90

**SDCM/L90 B10:** < 2 / 50000

### Electrical features

**Driver included:** YES

**Driver position:** integrated

**Driver type:** On-Off

**Isolation class:** Class I

### Optical features

**Beam angle:** 12°

**Optical type, adjustability:** Fixed

**Interchangeable optic (IOS):** NO

### Physical features

**Material:** Die-cast aluminum

**Mounting:** Track, Suspension

**Finishing:** Brushed aluminum

**Weight:** 1.35Kg

### Notes:

Cable length 3m

Luminaire constructed in conformity with Directives 2014/35/EU (LV), 2014/30/EU (EMC), 2009/125/EC (Ecodesign) with Regulations (EC) No 245/2009, (EU) No 347/2010 and (EU) 2015/1428 (for luminaires with fluorescent and metal halide lamps only), 2009/125/EC (Ecodesign) with Regulations (EU) No 1194/2012 and 2015/1428 (for LED luminaires only), 2011/65/EU (RoHS 2) and 2012/19/EU (WEEE).

### Reggiani SPA Illuminazione

Viale Monza, 16 20845 Sovico (MB) Italy  
Tel. (+39) 039 2071.1 fax (+39) 039 2071 999

www.reggiani.net  
contact@reggiani.net

## Photometries



## Tracks/channels

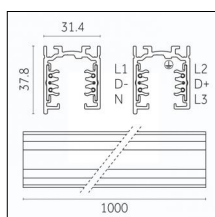
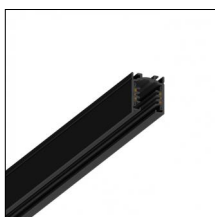

### Code 0.02030.0010 - 3-circuit track surface/pendant

Finishing: White (Standard)  
Length: 1000mm Width: 31.4mm Height: 37.8mm

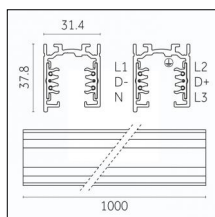

### Code 0.02030.0021 - 3-circuit track surface/pendant

Finishing: Black (Standard)  
Length: 1000mm Width: 31.4mm Height: 37.8mm

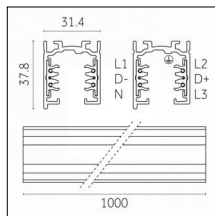
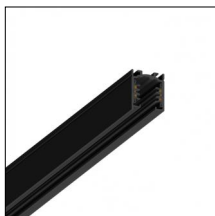

### Code 0.02030.0028 - 3-circuit track surface/pendant

Finishing: Metallised grey (Standard)  
Length: 1000mm Width: 31.4mm Height: 37.8mm

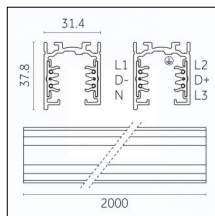

### Code 0.02031.0010 - 3-circuit track surface/pendant

Finishing: White (Standard)  
Length: 2000mm Width: 31.4mm Height: 37.8mm

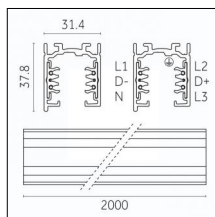
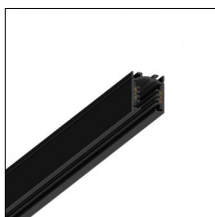

### Code 0.02031.0021 - 3-circuit track surface/pendant

Finishing: Black (Standard)  
Length: 2000mm Width: 31.4mm Height: 37.8mm

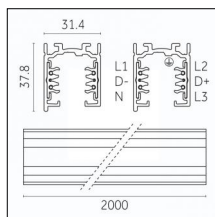
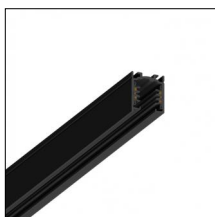

### Code 0.02031.0028 - 3-circuit track surface/pendant

Finishing: Metallised grey (Standard)  
Length: 2000mm Width: 31.4mm Height: 37.8mm

Luminaire constructed in conformity with Directives 2014/35/EU (LV), 2014/30/EU (EMC), 2009/125/EC (Ecodesign) with Regulations (EC) No 245/2009, (EU) No 347/2010 and (EU) 2015/1428 (for luminaires with fluorescent and metal halide lamps only), 2009/125/EC (Ecodesign) with Regulations (EU) No 1194/2012 and 2015/1428 (for LED luminaires only), 2011/65/EU (RoHS 2) and 2012/19/EU (WEEE).

## Tracks/channels

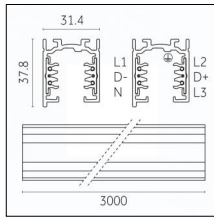
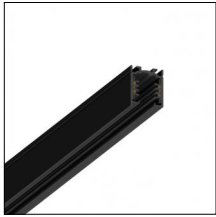

### Code 0.02032.0010 - 3-circuit track surface/pendant

Finishing: White (Standard)  
Length: 3000mm Width: 31.4mm Height: 37.8mm

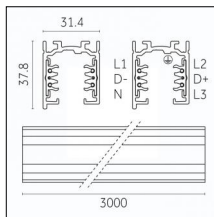
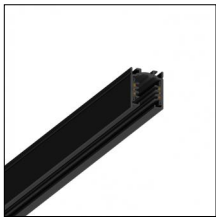

### Code 0.02032.0021 - 3-circuit track surface/pendant

Finishing: Black (Standard)  
Length: 3000mm Width: 31.4mm Height: 37.8mm

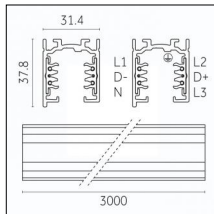

### Code 0.02032.0028 - 3-circuit track surface/pendant

Finishing: Metallised grey (Standard)  
Length: 3000mm Width: 31.4mm Height: 37.8mm

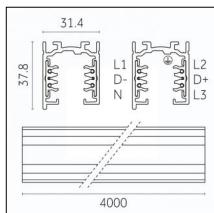

### Code 0.02033.0010 - 3-circuit track surface/pendant

Finishing: White (Standard)  
Length: 4000mm Width: 31.4mm Height: 37.8mm

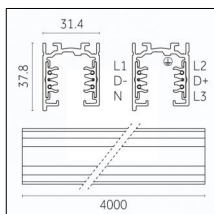

### Code 0.02033.0021 - 3-circuit track surface/pendant

Finishing: Black (Standard)  
Length: 4000mm Width: 31.4mm Height: 37.8mm

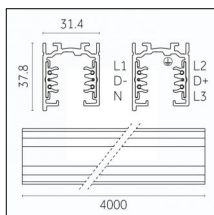

### Code 0.02033.0028 - 3-circuit track surface/pendant

Finishing: Metallised grey (Standard)  
Length: 4000mm Width: 31.4mm Height: 37.8mm

Luminaire constructed in conformity with Directives 2014/35/EU (LV), 2014/30/EU (EMC), 2009/125/EC (Ecodesign) with Regulations (EC) No 245/2009, (EU) No 347/2010 and (EU) 2015/1428 (for luminaires with fluorescent and metal halide lamps only), 2009/125/EC (Ecodesign) with Regulations (EU) No 1194/2012 and 2015/1428 (for LED luminaires only), 2011/65/EU (RoHS 2) and 2012/19/EU (WEEE).



## Tracks/channels

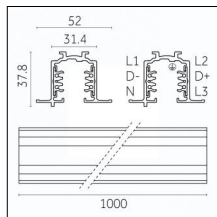

**Code 0.02034.0010 - 3-circuit track recessed**

Finishing: White (Standard)  
Length: 1000mm Width: 52mm Height: 37.8mm

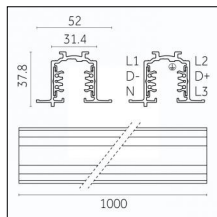

**Code 0.02034.0021 - 3-circuit track recessed**

Finishing: Black (Standard)  
Length: 1000mm Width: 52mm Height: 37.8mm

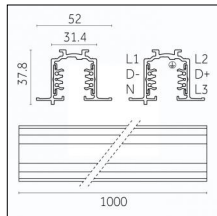

**Code 0.02034.0028 - 3-circuit track recessed**

Finishing: Metallised grey (Standard)  
Length: 1000mm Width: 52mm Height: 37.8mm

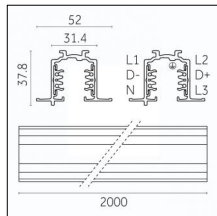

**Code 0.02035.0010 - 3-circuit track recessed**

Finishing: White (Standard)  
Length: 2000mm Width: 52mm Height: 37.8mm

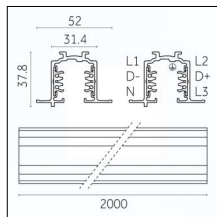

**Code 0.02035.0021 - 3-circuit track recessed**

Finishing: Black (Standard)  
Length: 2000mm Width: 52mm Height: 37.8mm

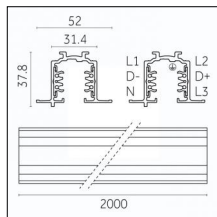

**Code 0.02035.0028 - 3-circuit track recessed**

Finishing: Metallised grey (Standard)  
Length: 2000mm Width: 52mm Height: 37.8mm

Luminaire constructed in conformity with Directives 2014/35/EU (LV), 2014/30/EU (EMC), 2009/125/EC (Ecodesign) with Regulations (EC) No 245/2009, (EU) No 347/2010 and (EU) 2015/1428 (for luminaires with fluorescent and metal halide lamps only), 2009/125/EC (Ecodesign) with Regulations (EU) No 1194/2012 and 2015/1428 (for LED luminaires only), 2011/65/EU (RoHS 2) and 2012/19/EU (WEEE).

## Tracks/channels

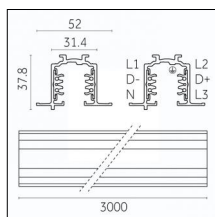

**Code 0.02036.0010 - 3-circuit track recessed**

Finishing: White (Standard)  
Length: 3000mm Width: 52mm Height: 37.8mm

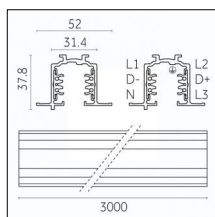

**Code 0.02036.0021 - 3-circuit track recessed**

Finishing: Black (Standard)  
Length: 3000mm Width: 52mm Height: 37.8mm

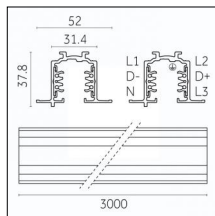

**Code 0.02036.0028 - 3-circuit track recessed**

Finishing: Metallised grey (Standard)  
Length: 3000mm Width: 52mm Height: 37.8mm

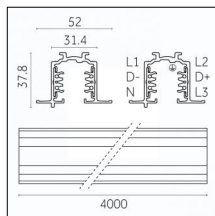

**Code 0.02037.0010 - 3-circuit track recessed**

Finishing: White (Standard)  
Length: 4000mm Width: 52mm Height: 37.8mm

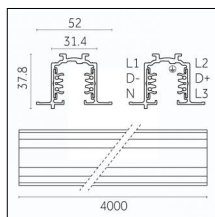

**Code 0.02037.0021 - 3-circuit track recessed**

Finishing: Black (Standard)  
Length: 4000mm Width: 52mm Height: 37.8mm

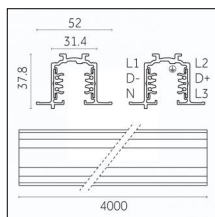

**Code 0.02037.0028 - 3-circuit track recessed**

Finishing: Metallised grey (Standard)  
Length: 4000mm Width: 52mm Height: 37.8mm

Luminaire constructed in conformity with Directives 2014/35/EU (LV), 2014/30/EU (EMC), 2009/125/EC (Ecodesign) with Regulations (EC) No 245/2009, (EU) No 347/2010 and (EU) 2015/1428 (for luminaires with fluorescent and metal halide lamps only), 2009/125/EC (Ecodesign) with Regulations (EU) No 1194/2012 and 2015/1428 (for LED luminaires only), 2011/65/EU (RoHS 2) and 2012/19/EU (WEEE).

## Tracks/channels

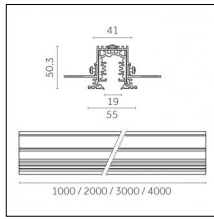

### Code 0.27101.0021 - 3-circuit track Supertrack

Finishing: Black (Standard)  
Length: 1000mm Width: 41mm Height: 50mm

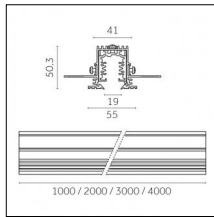

### Code 0.27102.0021 - 3-circuit track Supertrack

Finishing: Black (Standard)  
Length: 2000mm Width: 41mm Height: 50mm

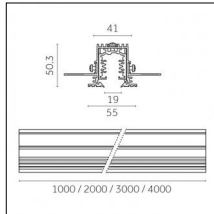

### Code 0.27103.0021 - 3-circuit track Supertrack

Finishing: Black (Standard)  
Length: 3000mm Width: 41mm Height: 50mm

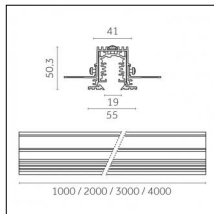

### Code 0.27104.0021 - 3-circuit track Supertrack

Finishing: Black (Standard)  
Length: 4000mm Width: 41mm Height: 50mm

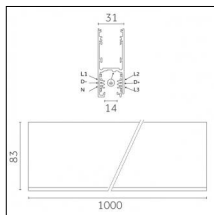
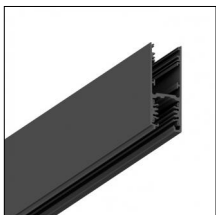

### Code 0.02505.0010 - H Track | Surface/Pendant

Finishing: White (Standard)  
Length: 1000mm Width: 31mm Height: 83mm

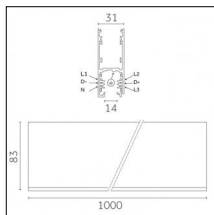
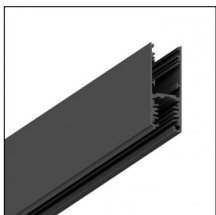

### Code 0.02505.0021 - H Track | Surface/Pendant

Finishing: Black (Standard)  
Length: 1000mm Width: 31mm Height: 83mm

Luminaire constructed in conformity with Directives 2014/35/EU (LV), 2014/30/EU (EMC), 2009/125/EC (Ecodesign) with Regulations (EC) No 245/2009, (EU) No 347/2010 and (EU) 2015/1428 (for luminaires with fluorescent and metal halide lamps only), 2009/125/EC (Ecodesign) with Regulations (EU) No 1194/2012 and 2015/1428 (for LED luminaires only), 2011/65/EU (RoHS 2) and 2012/19/EU (WEEE).

## Tracks/channels

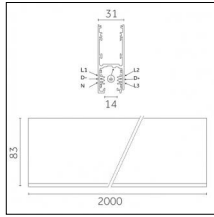

### Code 0.02506.0010 - H Track | Surface/Pendant

Finishing: White (Standard)  
Length: 2000mm Width: 31mm Height: 83mm

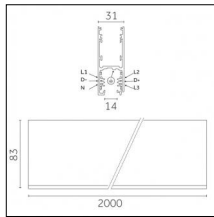

### Code 0.02506.0021 - H Track | Surface/Pendant

Finishing: Black (Standard)  
Length: 2000mm Width: 31mm Height: 83mm

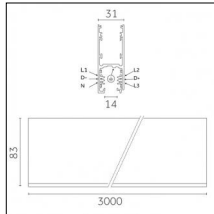

### Code 0.02507.0010 - H Track | Surface/Pendant

Finishing: White (Standard)  
Length: 3000mm Width: 31mm Height: 83mm

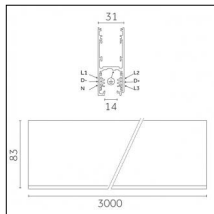

### Code 0.02507.0021 - H Track | Surface/Pendant

Finishing: Black (Standard)  
Length: 3000mm Width: 31mm Height: 83mm

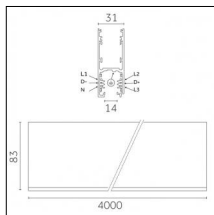

### Code 0.02508.0010 - H Track | Surface/Pendant

Finishing: White (Standard)  
Length: 4000mm Width: 31mm Height: 83mm

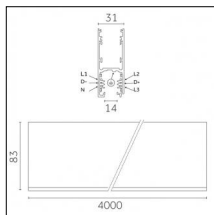

### Code 0.02508.0021 - H Track | Surface/Pendant

Finishing: Black (Standard)  
Length: 4000mm Width: 31mm Height: 83mm

## Optics

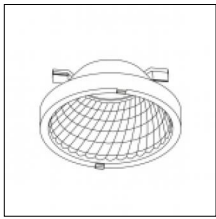

**Code 0.35037.0000 - LL7 - Very wide beam (53°) - LED**

Finishing:  
Description:

Wide Wide

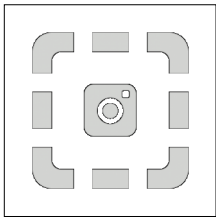

**Code 0.35038.0000 - LL7 - Very wide beam (53°) - LED**

Finishing:  
Description:

Very wide Very wide

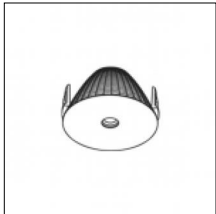

**Code 0.35135.0000 - Ø95mm precision optic 12° - LED**

Finishing:  
Description:



Narrow 12°

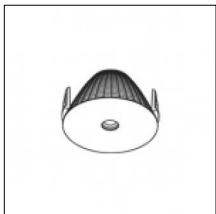

**Code 0.35136.0000 - Ø95mm precision optic 24° - LED**

Finishing:  
Description:



Medium 24°

## Accessories

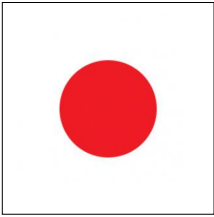

**Code 0.26406.004A - Red glass filter 1 mm**

Type: Optical  
Finishing: Red

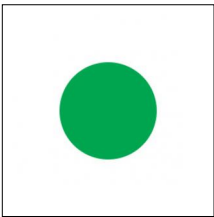

**Code 0.26406.005A - Green glass filter 1 mm**

Type: Optical  
Finishing: Green

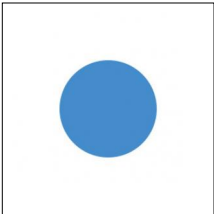

**Code 0.26406.006A - Blue glass filter 1 mm**

Type: Optical  
Finishing: Blue

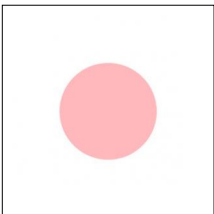

**Code 0.26406.007A - Pink glass filter 1 mm**

Type: Optical  
Finishing: Pink

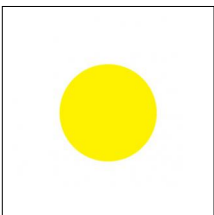

**Code 0.26406.008A - Yellow glass filter 1 mm**

Type: Optical  
Finishing: Yellow

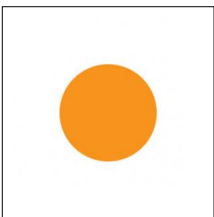

**Code 0.26406.009A - Orange glass filter 1 mm**

Type: Optical  
Finishing: Orange

## Accessories

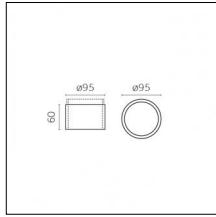

### Code 0.26047.0000 - Cylinder, Hollow version

Type: Optical  
 Finishing: Without finish / Stainles Steel / Natural aluminium (Standard)  
 Height: 60mm  
 Description: Hollow version



### Code 0.26414.0000 - Colored Gel Slides (2 pieces)

Type: Optical  
 Finishing: Without finish / Stainles Steel / Natural aluminium (Standard)

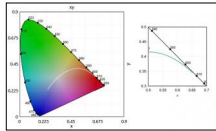
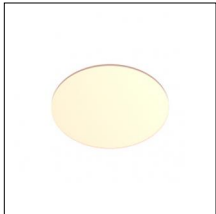

### Code 0.26422.0000 - Selective filter 2700K - 2500K

Type: Optical  
 Finishing: Without finish / Stainles Steel / Natural aluminium (Standard)

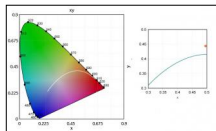
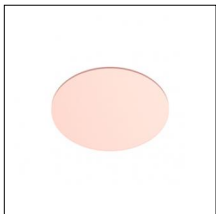

### Code 0.26430.0000 - Selective filter 2700K - 2200K

Type: Optical  
 Finishing: Without finish / Stainles Steel / Natural aluminium (Standard)

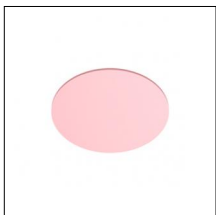

### Code 0.26438.0000 - Selective filter 2700K - 2000K

Type: Optical  
 Finishing: Without finish / Stainles Steel / Natural aluminium (Standard)

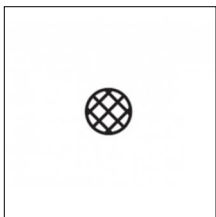

### Code 0.26446.0000 - Honeycomb dense texture

Type: Optical  
 Finishing: Without finish / Stainles Steel / Natural aluminium (Standard)

## Accessories

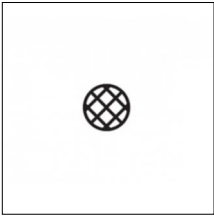

### Code 0.26454.0000 - Honeycomb wide texture

Type: Optical

Finishing: Without finish / Stainles Steel / Natural aluminium (Standard)

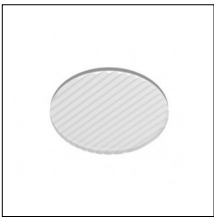

### Code 0.26459.0000 - Ribbed glass

Type: Optical

Finishing: Without finish / Stainles Steel / Natural aluminium (Standard)

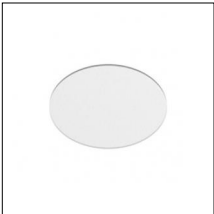

### Code 0.26466.0000 - Opal lens

Type: Optical

Finishing: Without finish / Stainles Steel / Natural aluminium (Standard)

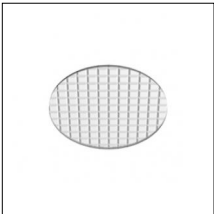

### Code 0.26474.0000 - Diffusive lens

Type: Optical

Finishing: Without finish / Stainles Steel / Natural aluminium (Standard)

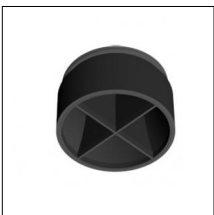

### Code 0.26479.0000 - Cross blade louver

Type: Optical

Finishing: Without finish / Stainles Steel / Natural aluminium (Standard)

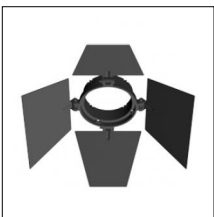

### Code 0.26487.0000 - Barn doors

Type: Optical

Finishing: Without finish / Stainles Steel / Natural aluminium (Standard)



## Accessories



### Code 0.26491.0012 - Cone 45 ° wall washer

Type: Optical  
Finishing: Embossed matt white (Standard)



### Code 0.26491.0031 - Cone 45 ° wall washer

Type: Optical  
Finishing: Embossed matt black (Standard)

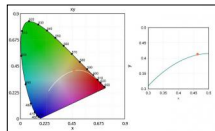
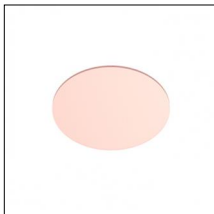

### Code 0.26563.0000 - Selective filter 3000K-2700K

Type: Optical  
Finishing: Without finish / Stainles Steel / Natural aluminium (Standard)

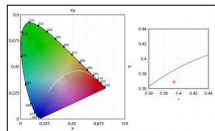
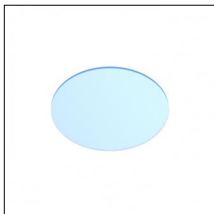

### Code 0.26571.0000 - Selective filter 3000K-3600K

Type: Optical  
Finishing: Without finish / Stainles Steel / Natural aluminium (Standard)

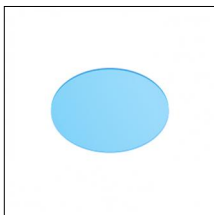

### Code 0.26579.0000 - Selective filter 3000K-4000K

Type: Optical  
Finishing: Without finish / Stainles Steel / Natural aluminium (Standard)

Indoor | Pendants | Yori Pendant Ghostrack Ø95mm

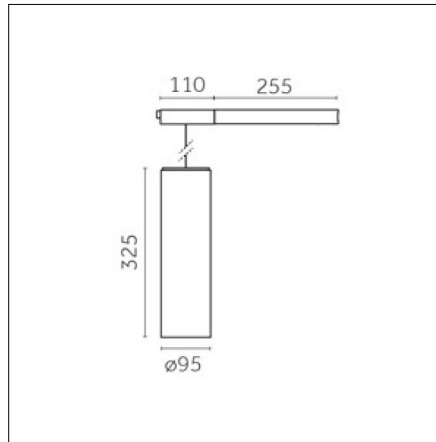

Narrow 12°



IP20



Risk 1

850°



**Code 0.NM74B.HQL0**

### Light source features

**Number of light sources:** 1

**Source type:** LED HQ

**Watt:** 17W

**Lm:** 2122lm

**Lm/W:** 125lm/W

**Kelvin/CRI:** 3000K / >90

**SDCM/L90 B10:** < 2 / 50000

### Electrical features

**Driver included:** YES

**Driver position:** integrated

**Driver type:** On-Off

**Isolation class:** Class I

### Optical features

**Beam angle:** 12°

**Optical type, adjustability:** Fixed

**Interchangeable optic (IOS):** NO

### Physical features

**Material:** Die-cast aluminum

**Mounting:** Track, Suspension

**Finishing:** Antiqued brushed bronze

**Weight:** 1.74Kg

### Notes:

Cable length 3m

Luminaire constructed in conformity with Directives 2014/35/EU (LV), 2014/30/EU (EMC), 2009/125/EC (Ecodesign) with Regulations (EC) No 245/2009, (EU) No 347/2010 and (EU) 2015/1428 (for luminaires with fluorescent and metal halide lamps only), 2009/125/EC (Ecodesign) with Regulations (EU) No 1194/2012 and 2015/1428 (for LED luminaires only), 2011/65/EU (RoHS 2) and 2012/19/EU (WEEE).

**Reggiani SPA Illuminazione**

Viale Monza, 16 20845 Sovico (MB) Italy  
Tel. (+39) 039 2071.1 fax (+39) 039 2071 999

www.reggiani.net  
contact@reggiani.net

## Photometries



## Tracks/channels

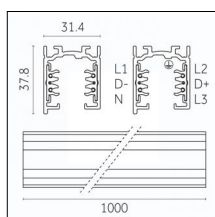

### Code 0.02030.0010 - 3-circuit track surface/pendant

Finishing: White (Standard)  
Length: 1000mm Width: 31.4mm Height: 37.8mm

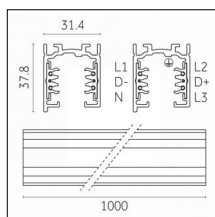
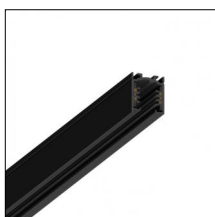

### Code 0.02030.0021 - 3-circuit track surface/pendant

Finishing: Black (Standard)  
Length: 1000mm Width: 31.4mm Height: 37.8mm

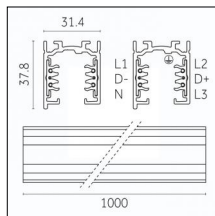
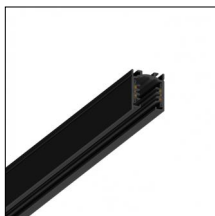

### Code 0.02030.0028 - 3-circuit track surface/pendant

Finishing: Metallised grey (Standard)  
Length: 1000mm Width: 31.4mm Height: 37.8mm

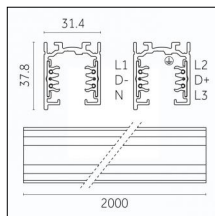
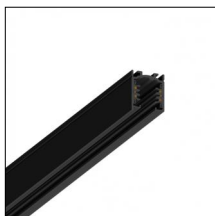

### Code 0.02031.0010 - 3-circuit track surface/pendant

Finishing: White (Standard)  
Length: 2000mm Width: 31.4mm Height: 37.8mm

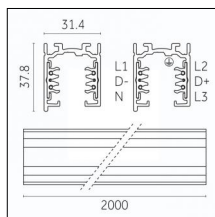

### Code 0.02031.0021 - 3-circuit track surface/pendant

Finishing: Black (Standard)  
Length: 2000mm Width: 31.4mm Height: 37.8mm

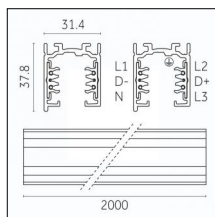

### Code 0.02031.0028 - 3-circuit track surface/pendant

Finishing: Metallised grey (Standard)  
Length: 2000mm Width: 31.4mm Height: 37.8mm

Luminaire constructed in conformity with Directives 2014/35/EU (LV), 2014/30/EU (EMC), 2009/125/EC (Ecodesign) with Regulations (EC) No 245/2009, (EU) No 347/2010 and (EU) 2015/1428 (for luminaires with fluorescent and metal halide lamps only), 2009/125/EC (Ecodesign) with Regulations (EU) No 1194/2012 and 2015/1428 (for LED luminaires only), 2011/65/EU (RoHS 2) and 2012/19/EU (WEEE).

## Tracks/channels

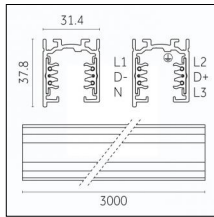
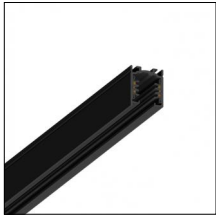

### Code 0.02032.0010 - 3-circuit track surface/pendant

Finishing: White (Standard)  
Length: 3000mm Width: 31.4mm Height: 37.8mm

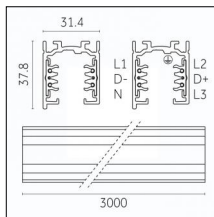

### Code 0.02032.0021 - 3-circuit track surface/pendant

Finishing: Black (Standard)  
Length: 3000mm Width: 31.4mm Height: 37.8mm

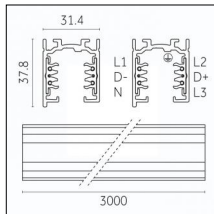

### Code 0.02032.0028 - 3-circuit track surface/pendant

Finishing: Metallised grey (Standard)  
Length: 3000mm Width: 31.4mm Height: 37.8mm

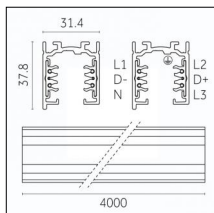

### Code 0.02033.0010 - 3-circuit track surface/pendant

Finishing: White (Standard)  
Length: 4000mm Width: 31.4mm Height: 37.8mm

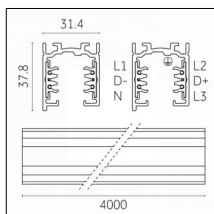

### Code 0.02033.0021 - 3-circuit track surface/pendant

Finishing: Black (Standard)  
Length: 4000mm Width: 31.4mm Height: 37.8mm

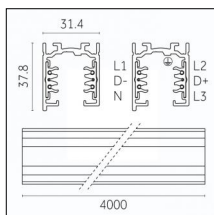

### Code 0.02033.0028 - 3-circuit track surface/pendant

Finishing: Metallised grey (Standard)  
Length: 4000mm Width: 31.4mm Height: 37.8mm

Luminaire constructed in conformity with Directives 2014/35/EU (LV), 2014/30/EU (EMC), 2009/125/EC (Ecodesign) with Regulations (EC) No 245/2009, (EU) No 347/2010 and (EU) 2015/1428 (for luminaires with fluorescent and metal halide lamps only), 2009/125/EC (Ecodesign) with Regulations (EU) No 1194/2012 and 2015/1428 (for LED luminaires only), 2011/65/EU (RoHS 2) and 2012/19/EU (WEEE).

## Tracks/channels

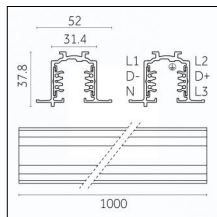

**Code 0.02034.0010 - 3-circuit track recessed**

Finishing: White (Standard)  
Length: 1000mm Width: 52mm Height: 37.8mm

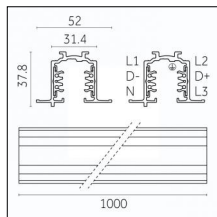

**Code 0.02034.0021 - 3-circuit track recessed**

Finishing: Black (Standard)  
Length: 1000mm Width: 52mm Height: 37.8mm

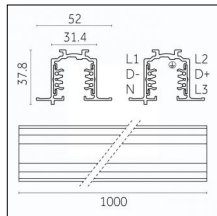

**Code 0.02034.0028 - 3-circuit track recessed**

Finishing: Metallised grey (Standard)  
Length: 1000mm Width: 52mm Height: 37.8mm

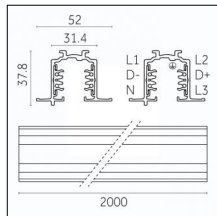

**Code 0.02035.0010 - 3-circuit track recessed**

Finishing: White (Standard)  
Length: 2000mm Width: 52mm Height: 37.8mm

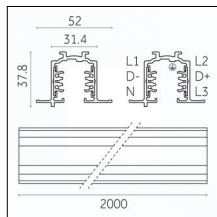

**Code 0.02035.0021 - 3-circuit track recessed**

Finishing: Black (Standard)  
Length: 2000mm Width: 52mm Height: 37.8mm

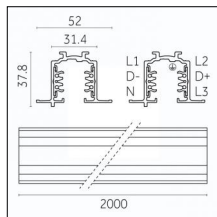

**Code 0.02035.0028 - 3-circuit track recessed**

Finishing: Metallised grey (Standard)  
Length: 2000mm Width: 52mm Height: 37.8mm

Luminaire constructed in conformity with Directives 2014/35/EU (LV), 2014/30/EU (EMC), 2009/125/EC (Ecodesign) with Regulations (EC) No 245/2009, (EU) No 347/2010 and (EU) 2015/1428 (for luminaires with fluorescent and metal halide lamps only), 2009/125/EC (Ecodesign) with Regulations (EU) No 1194/2012 and 2015/1428 (for LED luminaires only), 2011/65/EU (RoHS 2) and 2012/19/EU (WEEE).

## Tracks/channels

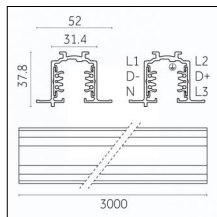

**Code 0.02036.0010 - 3-circuit track recessed**

Finishing: White (Standard)  
Length: 3000mm Width: 52mm Height: 37.8mm

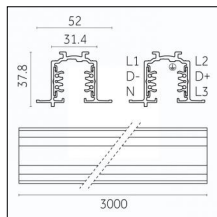

**Code 0.02036.0021 - 3-circuit track recessed**

Finishing: Black (Standard)  
Length: 3000mm Width: 52mm Height: 37.8mm

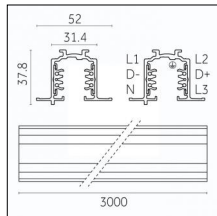

**Code 0.02036.0028 - 3-circuit track recessed**

Finishing: Metallised grey (Standard)  
Length: 3000mm Width: 52mm Height: 37.8mm

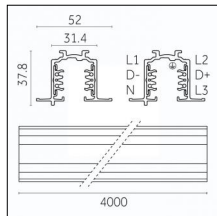

**Code 0.02037.0010 - 3-circuit track recessed**

Finishing: White (Standard)  
Length: 4000mm Width: 52mm Height: 37.8mm

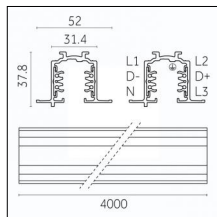

**Code 0.02037.0021 - 3-circuit track recessed**

Finishing: Black (Standard)  
Length: 4000mm Width: 52mm Height: 37.8mm

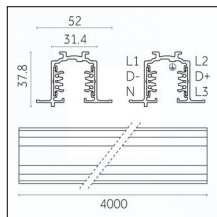

**Code 0.02037.0028 - 3-circuit track recessed**

Finishing: Metallised grey (Standard)  
Length: 4000mm Width: 52mm Height: 37.8mm

## Tracks/channels

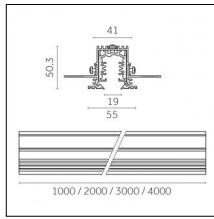

### Code 0.27101.0021 - 3-circuit track Supertrack

Finishing: Black (Standard)  
Length: 1000mm Width: 41mm Height: 50mm

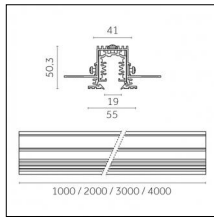

### Code 0.27102.0021 - 3-circuit track Supertrack

Finishing: Black (Standard)  
Length: 2000mm Width: 41mm Height: 50mm

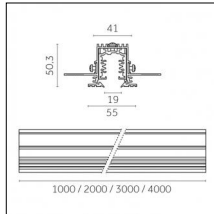

### Code 0.27103.0021 - 3-circuit track Supertrack

Finishing: Black (Standard)  
Length: 3000mm Width: 41mm Height: 50mm

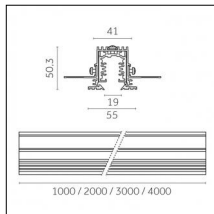

### Code 0.27104.0021 - 3-circuit track Supertrack

Finishing: Black (Standard)  
Length: 4000mm Width: 41mm Height: 50mm

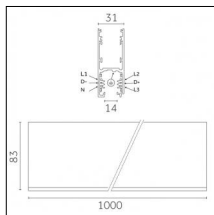
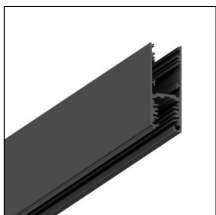

### Code 0.02505.0010 - H Track | Surface/Pendant

Finishing: White (Standard)  
Length: 1000mm Width: 31mm Height: 83mm

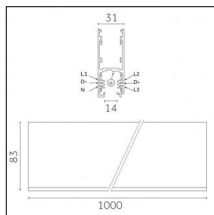
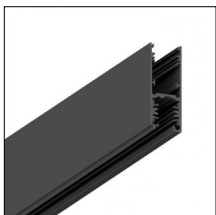

### Code 0.02505.0021 - H Track | Surface/Pendant

Finishing: Black (Standard)  
Length: 1000mm Width: 31mm Height: 83mm

Luminaire constructed in conformity with Directives 2014/35/EU (LV), 2014/30/EU (EMC), 2009/125/EC (Ecodesign) with Regulations (EC) No 245/2009, (EU) No 347/2010 and (EU) 2015/1428 (for luminaires with fluorescent and metal halide lamps only), 2009/125/EC (Ecodesign) with Regulations (EU) No 1194/2012 and 2015/1428 (for LED luminaires only), 2011/65/EU (RoHS 2) and 2012/19/EU (WEEE).



## Tracks/channels

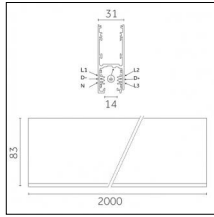

### Code 0.02506.0010 - H Track | Surface/Pendant

Finishing: White (Standard)  
Length: 2000mm Width: 31mm Height: 83mm

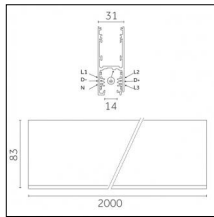

### Code 0.02506.0021 - H Track | Surface/Pendant

Finishing: Black (Standard)  
Length: 2000mm Width: 31mm Height: 83mm

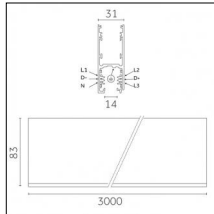

### Code 0.02507.0010 - H Track | Surface/Pendant

Finishing: White (Standard)  
Length: 3000mm Width: 31mm Height: 83mm

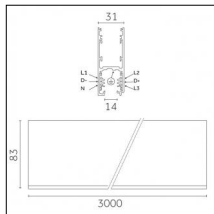

### Code 0.02507.0021 - H Track | Surface/Pendant

Finishing: Black (Standard)  
Length: 3000mm Width: 31mm Height: 83mm

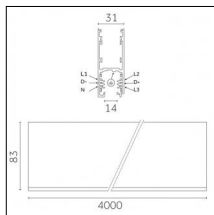
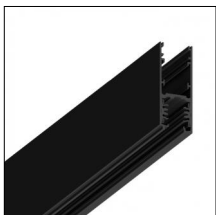

### Code 0.02508.0010 - H Track | Surface/Pendant

Finishing: White (Standard)  
Length: 4000mm Width: 31mm Height: 83mm

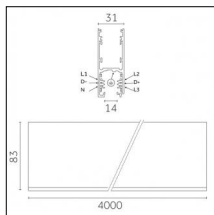

### Code 0.02508.0021 - H Track | Surface/Pendant

Finishing: Black (Standard)  
Length: 4000mm Width: 31mm Height: 83mm

## Optics

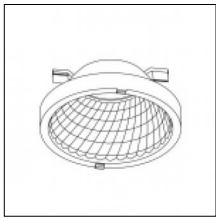

**Code 0.35037.0000 - LL7 - Very wide beam (53°) - LED**

Finishing:  
Description:

Wide Wide

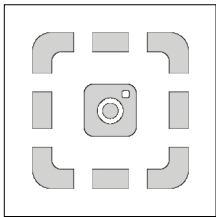

**Code 0.35038.0000 - LL7 - Very wide beam (53°) - LED**

Finishing:  
Description:

Very wide Very wide

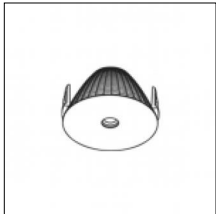

**Code 0.35135.0000 - Ø95mm precision optic 12° - LED**

Finishing:  
Description:



Narrow 12°

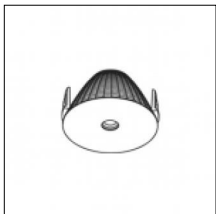

**Code 0.35136.0000 - Ø95mm precision optic 24° - LED**

Finishing:  
Description:



Medium 24°

## Accessories

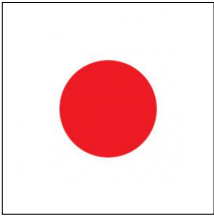

**Code 0.26406.004A - Red glass filter 1 mm**

Type: Optical  
Finishing: Red

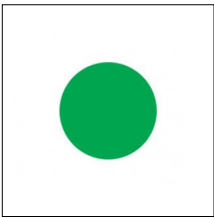

**Code 0.26406.005A - Green glass filter 1 mm**

Type: Optical  
Finishing: Green

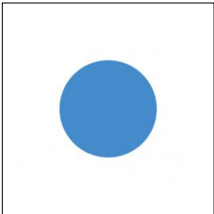

**Code 0.26406.006A - Blue glass filter 1 mm**

Type: Optical  
Finishing: Blue

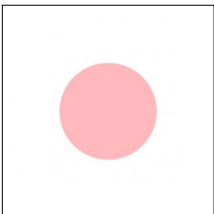

**Code 0.26406.007A - Pink glass filter 1 mm**

Type: Optical  
Finishing: Pink

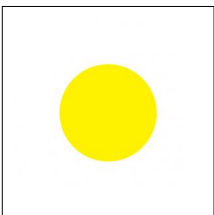

**Code 0.26406.008A - Yellow glass filter 1 mm**

Type: Optical  
Finishing: Yellow

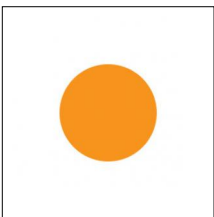

**Code 0.26406.009A - Orange glass filter 1 mm**

Type: Optical  
Finishing: Orange

## Accessories

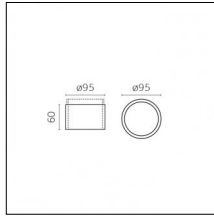

### Code 0.26047.0000 - Cylinder, Hollow version

Type: Optical  
 Finishing: Without finish / Stainles Steel / Natural aluminium (Standard)  
 Height: 60mm  
 Description: Hollow version



### Code 0.26414.0000 - Colored Gel Slides (2 pieces)

Type: Optical  
 Finishing: Without finish / Stainles Steel / Natural aluminium (Standard)

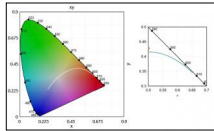
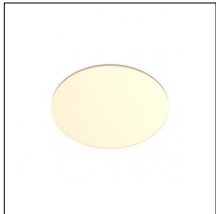

### Code 0.26422.0000 - Selective filter 2700K - 2500K

Type: Optical  
 Finishing: Without finish / Stainles Steel / Natural aluminium (Standard)

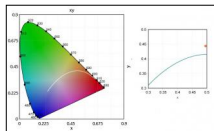
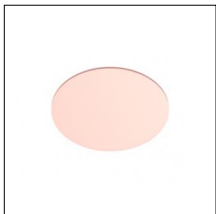

### Code 0.26430.0000 - Selective filter 2700K - 2200K

Type: Optical  
 Finishing: Without finish / Stainles Steel / Natural aluminium (Standard)



### Code 0.26438.0000 - Selective filter 2700K - 2000K

Type: Optical  
 Finishing: Without finish / Stainles Steel / Natural aluminium (Standard)

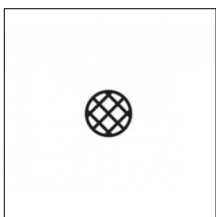

### Code 0.26446.0000 - Honeycomb dense texture

Type: Optical  
 Finishing: Without finish / Stainles Steel / Natural aluminium (Standard)

## Accessories

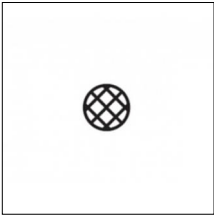

### Code 0.26454.0000 - Honeycomb wide texture

Type: Optical

Finishing: Without finish / Stainles Steel / Natural aluminium (Standard)

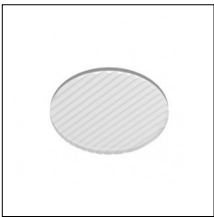

### Code 0.26459.0000 - Ribbed glass

Type: Optical

Finishing: Without finish / Stainles Steel / Natural aluminium (Standard)

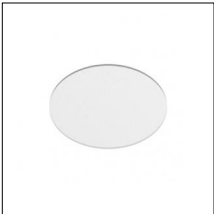

### Code 0.26466.0000 - Opal lens

Type: Optical

Finishing: Without finish / Stainles Steel / Natural aluminium (Standard)

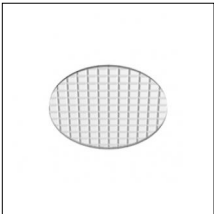

### Code 0.26474.0000 - Diffusive lens

Type: Optical

Finishing: Without finish / Stainles Steel / Natural aluminium (Standard)

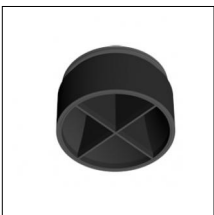

### Code 0.26479.0000 - Cross blade louver

Type: Optical

Finishing: Without finish / Stainles Steel / Natural aluminium (Standard)

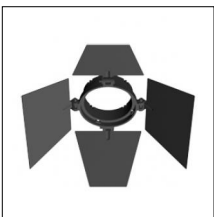

### Code 0.26487.0000 - Barn doors

Type: Optical

Finishing: Without finish / Stainles Steel / Natural aluminium (Standard)

## Accessories

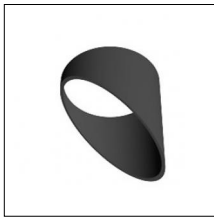

### Code 0.26491.0012 - Cone 45 ° wall washer

Type: Optical  
Finishing: Embossed matt white (Standard)



### Code 0.26491.0031 - Cone 45 ° wall washer

Type: Optical  
Finishing: Embossed matt black (Standard)

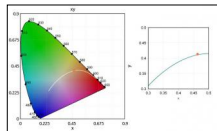
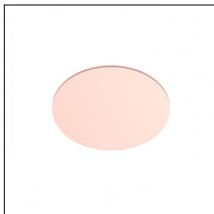

### Code 0.26563.0000 - Selective filter 3000K-2700K

Type: Optical  
Finishing: Without finish / Stainles Steel / Natural aluminium (Standard)

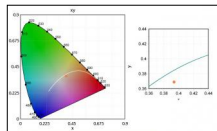
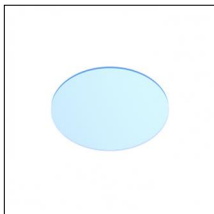

### Code 0.26571.0000 - Selective filter 3000K-3600K

Type: Optical  
Finishing: Without finish / Stainles Steel / Natural aluminium (Standard)

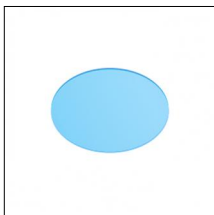

### Code 0.26579.0000 - Selective filter 3000K-4000K

Type: Optical  
Finishing: Without finish / Stainles Steel / Natural aluminium (Standard)