

GENERAL SPECIFICATION

Body and trim: Steel and aluminum.

Suspension: One stainless steel aircraft cable.

Power cable: Silver braided.

Finish: Silver anodized.

Diffusers: Opal acrylic with an etched finish.

Drivers: Luminaires supplied with HPF electronic drivers, 120/277V (EU-240V). 0-10V dimming standard (10%).

Mechanical: Mounts directly over a junction box (by others - North America only).

Integral Emergency system: Emergency option provides a 1.5 hour (3 hours for EU) emergency lighting facility. The self contained system includes the inverter module, NiCad batteries, LED charge indicator and test switch (NA only). Not available with a 347V supply.

L70 @25deg C (77deg F): > 50,000 hrs.

Delivered Lumens: Delivered lumens and LPW based on 3000K (min 80 CRI).



MOUNTING & OPTICS

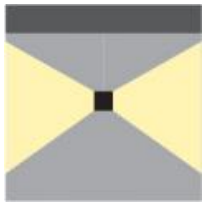

Interior - Suspended
2 sides

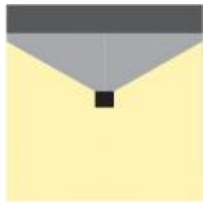

Interior - Suspended
3 sides

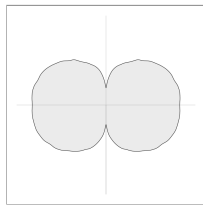

43 6052

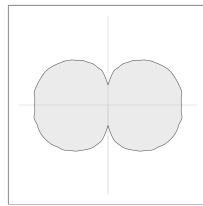

43 6054

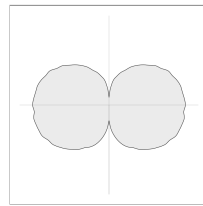

43 6056

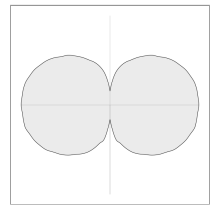

43 6058

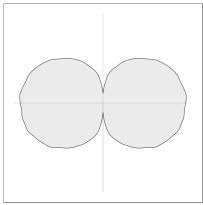

43 6071

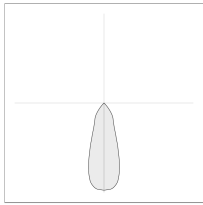

X1-ONLY

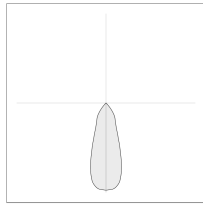

X1 ONLY

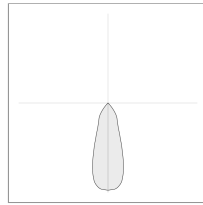

X1 ONLY

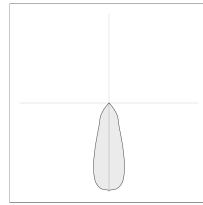

X1 ONLY

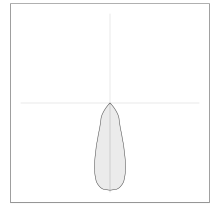

X1 ONLY

HOW TO ORDER

A SPECIFY LUMINAIRE

Code:	Power (LED):	Delivered lms:	LPW:	Height (A):	Height (B):
43 6052	48W	3659	78	457mm/18"	25mm/1"
43 6054	60W	4561	78	457mm/18"	25mm/1"
43 6056	72W	5321	76	610mm/27"	25mm/1"
43 6058	96W	7300	76	685mm/27"	25mm/1"
43 6071	115W	8635	75	1245mm/49"	46mm/1.8"

B SPECIFY CCT

30	3000K (min 80 CRI)
35	3500K (min 80 CRI)
40	4000K (min 80 CRI)

C SPECIFY DOWNLIGHT

X1	Xacara downlight 28W LED 3000K (2587lm delivered)
X2	Xacara downlight 28W LED 3500K (2665lm delivered)
X3	Xacara downlight 28W LED 4000K (2690lm delivered)

D SPECIFY EMERGENCY

EM	Integral Emergency
----	--------------------

EXAMPLE SPECIFICATION CODE

436052/35

DIMENSIONAL DIAGRAMS

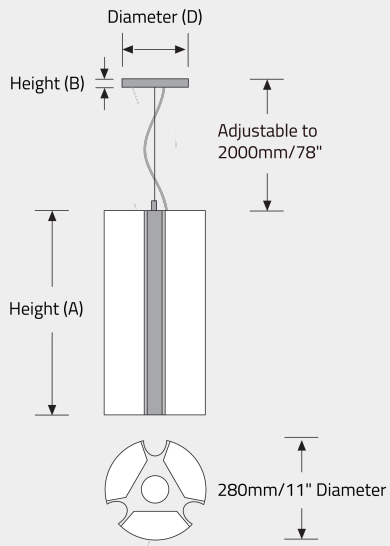

APPROVALS

