

BULKHEAD

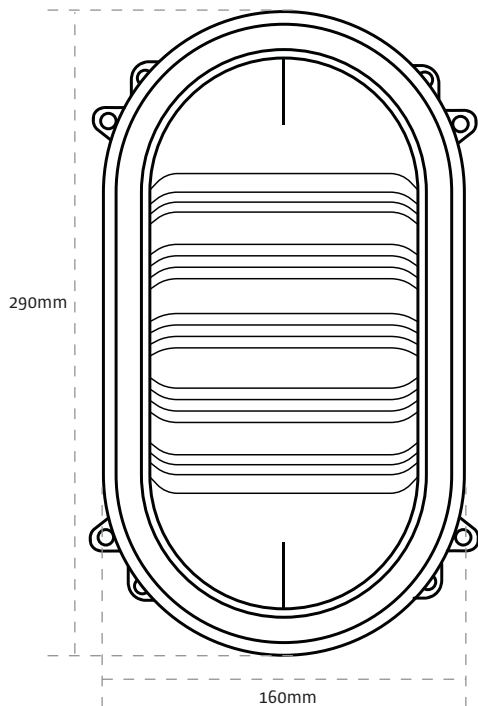

PERFORMANCE DATA

Lamp Type:	Xicato XTM Standard/Artist
CRI:	+80/+95
Luminous Flux:	720 - 2700lm
Power Consumption:	5.6W - 22.3W
Drive Current:	350mA - 700mA
Colour Temperatures:	2700K, 3000K, 3800K, 4000K
Colour Consistency:	1-2 Step MacAdam Ellipses
Colour Stability:	<0.003 Δ u', v' 5 years/44,000 hrs. warranty
Operating Temp:	<90°C
Class:	Class III
Control:	1-10V/DALI

CONSTRUCTION

Fitting:	M20 Conduit/Cable gland & IP54 rose
Cable Type:	3 core round, fabric covered, 0.75mm CSA, double insulated
Cable Colours:	Jet Black/Bright Red/Dark Brown/Burgundy/Bright Blue/Elephant Grey/ Silver/Antique White/Pea Green/Olive Brown/Cream/Copper/Purple/Yellow/Bright Orange/Neon Yellow/Neon Green/Navy/Racing Green/Fuschia Pink/Gold/Black & White/Red & White/Pale Linen/Dark Grey Linen
Weight:	2.4kg

XICATO XTM 19MM - SPECIFICATION TABLE FOR STANDARD SERIES

Nominal Flux	Colour Temperature (K)				CRI (Ra)	Drive Current (mA)	Lumen Output at 70°C (lm)	Power Consumption (W)	Efficacy (lm/W)	Life (Hrs.)
	2700	3000	3500	4000						
1300 lm	●	●	●	●	83	700	1300	11.7	111	L80/C3 50K
						500	965	8.2	118	
						350	720	5.6	129	
2000 lm	●	●	●	●	83	700	2000	19.5	102	L80/C3 50K
						500	1490	13.6	110	
						350	1105	9.3	119	
3000 lm	●	●	●	●	83	1050	3000	29.3	102	L80/C3 50K
						700	2100	18.9	111	
						500	1585	13.2	120	
4000 lm	●	●	●	●	83	1400	4000	39.1	102	L80/C3 50K
						1050	3080	28.5	108	
						700	2160	18.6	116	
5000 lm	●	●	●	●	83	500	1630	13.0	125	L80/C3 50K
						1400	5000	46.8	107	
						1050	3850	34.1	113	
						700	2700	22.3	121	
						500	2030	15.6	130	

XICATO XTM 19MM - SPECIFICATION TABLE FOR ARTIST SERIES

Nominal Flux	Colour Temperature (K)				CRI (Ra)	Drive Current (mA)	Lumen Output at 70°C (lm)	Power Consumption (W)	Efficacy (lm/W)	Life (Hrs.)
	2700	3000	3500	4000						
1300 lm	●	●	●	●	98	700	1300	15.6	83	L80/C3 50K
						500	965	10.9	89	
						350	720	7.4	97	
2000 lm	●	●	●	●	98	1050	2000	26.4	76	L80/C3 50K
						700	1400	17.0	82	
						500	1055	11.9	89	
3000 lm	●	●	●	●	98	350	800	8.2	98	L80/C3 50K
						1050	3000	34.1	88	
						700	2140	22.3	96	
						500	1580	15.6	101	
						350	1240	10.8	115	

WIRING DATA

Wire type: Solid or stranded copper

Maximum LED wiring length (driver to LED):

Wire core cross section: 0.5 - 1.5 mm², AWG 20 - 16

CSA (mm ²)	0.52	0.65	0.82	1.04	1.31
AWG value	20	19	18	17	16
Distance (m)	14	18	22	28	36
Distance (ft)	46	59	72	92	118

CAUTION: Please observe voltage drop over long cable lengths
CAUTION: Longer cable lengths increase EMI susceptibility.

DATA COMPARISON BETWEEN STANDARD AND ARTIST SERIES

STANDARD:

Colour Consistency - Initial

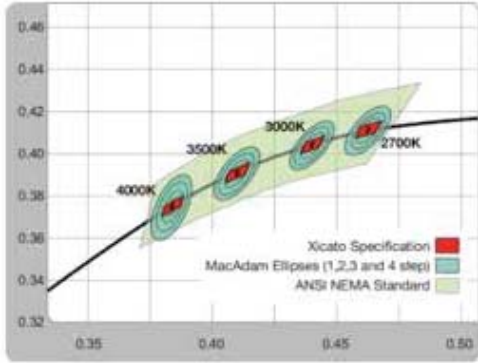

ARTIST:

Colour Consistency - Initial

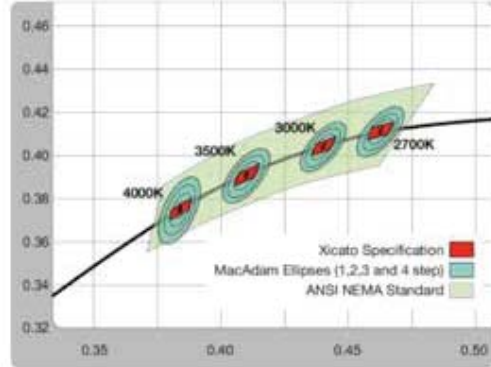

Colour Consistency - Maintained

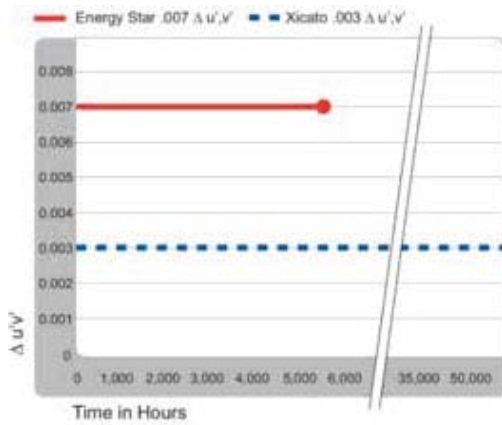

Colour Consistency - Maintained

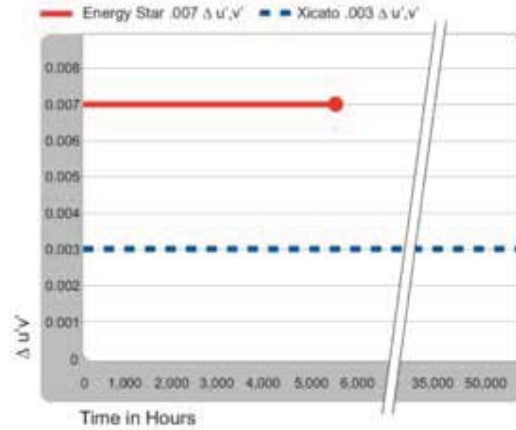

Spectral Power Distribution

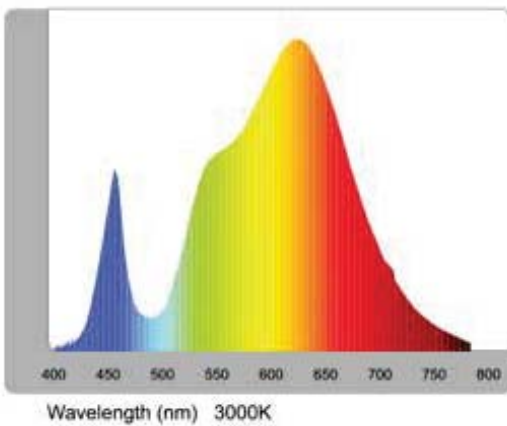

Spectral Power Distribution



STANDARD:

Colour Rendering Index (3000K Typical)

Ra	R1	R2	R3	R4	R5	R6	R7	R8	R9	R10	R11	R12	R13	R14	R15
83	82	89	95	84	82	87	86	65	16	64	79	58	81	93	75

ARTIST:

Colour Rendering Index (3000K Typical)

Ra	R1	R2	R3	R4	R5	R6	R7	R8	R9	R10	R11	R12	R13	R14	R15
98	98	99	98	98	98	97	98	98	98	99	98	88	98	98	98

Product Type

Optical Systems for COB LEDs

Product Diameter

(d) 051 - 060

Beam

Ultra Wide Beam

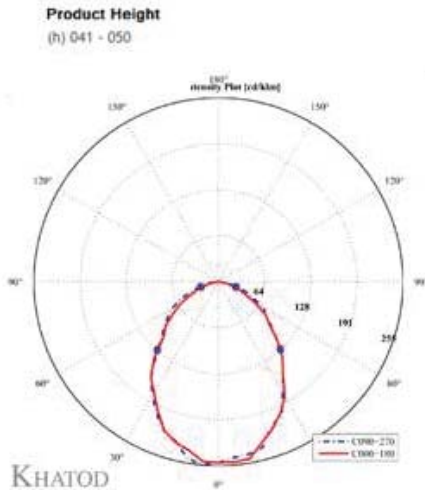

Product Type

Optical Systems for COB LEDs

Product Diameter

(d) 051 - 060

Beam

Wide Beam

