

REFLECTOR 190MM

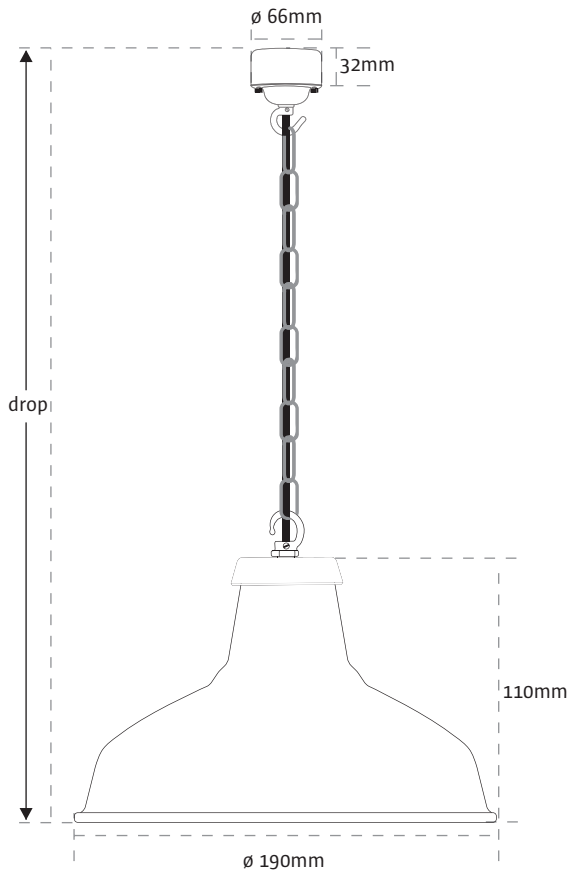

PERFORMANCE DATA

Lamp Type:	Xicato XTM Standard/Artist
CRI:	+80/+95
Luminous Flux:	400 - 1240lm
Power Consumption:	3.7W - 10.8W
Drive Current:	350mA - 500mA
Colour Temperatures:	2700K, 3000K, 3500K, 4000K
Colour Consistency:	1-2 Step MacAdam Ellipses
Colour Stability:	<0.003 Δ u',v' 5 years/44,000 hrs. warranty
Beam Angles:	14°, 25°, 38°
Accessories:	Ultra Wide Beam Diffuser Wide Beam Diffuser
Operating Temp:	<90°C
Class:	Class III
Control:	1-10V/DALI

CONSTRUCTION

Ceiling Rose Type:	Type 1 Hook/Type 4 Hook/Type 5 Hook
Ceiling Rose Colours:	Bronze/Silver/Brass/Zinc Alloy/Galvanised/Black/Gold
Cable Type:	2 core twist, fabric covered, 0.75mm CSA, double insulated
Cable Colours:	Jet Black/Bright Red/Dark Brown/Burgundy/Bright Blue/Elephant Grey/ Silver/Antique White/Pea Green/Olive Brown/Cream/Copper/Purple/Yellow/ Bright Orange/Neon Yellow/Neon Green/Navy/ Racing Green/Fuschia Pink/Gold/ Black & White/Red & White/Pale Linen/Dark Grey Linen
Chain Finishes:	Bronze/Silver/Galvanised/Rusty/Raw/Black/Gold
Shade Finish:	Bronze/Silver/Galvanised/Rusty/Raw/Black/Galvanised/Retro silver/Gold/Vitreous enamel
Enamel Colours:	Grey/Red/Green/Gloss Black/Matt Black/White
Weight:	2.01kg (based on 2000mm drop)

WIRING DATA

Wire type:	Solid or stranded copper
Wire core cross section:	0.5 - 1.5 mm ² , AWG 20 - 16

Maximum LED wiring length (driver to LED):

CSA (mm ²)	0.52	0.65	0.82	1.04	1.31
AWG value	20	19	18	17	16
Distance (m)	14	18	22	28	36
Distance (ft)	46	59	72	92	118

CAUTION: Please observe voltage drop over long cable lengths
CAUTION: Longer cable lengths increase EMI susceptibility.

XICATO XTM 19MM - SPECIFICATION TABLE FOR STANDARD SERIES

Nominal Flux	Colour Temperature (K)				CRI (Ra)	Drive Current (mA)	Lumen Output at 70°C (lm)	Power Consumption (W)	Efficacy (Lm/W)	Life (Hrs.)
	2700	3000	3500	4000						
1300 lm	●	●	●	●	83	700	1300	11.7	111	L80/C3 50K
						500	965	8.2	118	
						350	720	5.6	129	
2000 lm	●	●	●	●	83	700	2000	19.5	102	L80/C3 50K
						500	1490	13.6	110	
						350	1105	9.3	119	
3000 lm	●	●	●	●	83	1050	3000	29.3	102	L80/C3 50K
						700	2100	18.9	111	
						500	1585	13.2	120	
						350	1195	9.1	131	
4000 lm	●	●	●	●	83	1400	4000	39.1	102	L80/C3 50K
						1050	3080	28.5	108	
						700	2160	18.6	116	
						500	1630	13.0	125	
5000 lm	●	●	●	●	83	1400	5000	46.8	107	L80/C3 50K
						1050	3850	34.1	113	
						700	2700	22.3	121	
						500	2030	15.6	130	

XICATO XTM 9MM - SPECIFICATION TABLE FOR STANDARD SERIES

Nominal Flux	Colour Temperature (K)				CRI (Ra)	Drive Current (mA)	Lumen Output at 70°C (lm)	Power Consumption (W)	Efficacy (Lm/W)	Life (Hrs.)
	2700	3000	3500	4000						
700 lm	●	●	●	●	83	700	700	7.8	90	L80/C3 50K
						500	550	5.4	102	
						350	400	3.7	108	
1300 lm	●	●	●	●	83	700	1300	15.6	83	L80/C3 50K
						500	965	10.9	89	
						350	720	7.4	97	
						-	-	-	-	
2000 lm	●	●	●	●	83	1050	2000	30.2	66	L80/C3 50K
						700	1400	19.5	72	
						500	1055	13.6	78	
						350	800	9.3	86	

XICATO XTM 19MM - SPECIFICATION TABLE FOR ARTIST SERIES

Nominal Flux	Colour Temperature (K)				CRI (Ra)	Drive Current (mA)	Lumen Output at 70°C (lm)	Power Consumption (W)	Efficacy (Lm/W)	Life (Hrs.)
	2700	3000	3500	4000						
1300 lm	●	●	●	●	98	700	1300	15.6	83	L80/C3 50K
						500	965	10.9	89	
						350	720	7.4	97	
2000 lm	●	●	●	●	98	1050	2000	26.4	76	L80/C3 50K
						700	1400	17.0	82	
						500	1055	11.9	89	
						350	800	8.2	98	
3000 lm	●	●	●	●	98	1050	3000	34.1	88	L80/C3 50K
						700	2140	22.3	96	
						500	1580	15.6	101	
						350	1240	10.8	115	

XICATO XTM 9MM - SPECIFICATION TABLE FOR ARTIST SERIES

Nominal Flux	Colour Temperature (K)				CRI (Ra)	Drive Current (mA)	Lumen Output at 70°C (lm)	Power Consumption (W)	Efficacy (Lm/W)	Life (Hrs.)
	2700	3000	3500	4000						
700 lm	●	●	●	●	98	700	700	9.7	72	L80/C3 50K
						500	550	6.8	81	
						350	400	4.6	87	
1300 lm	●	●	●	●	98	1050	1300	24.3	54	L80/C3 50K
						700	930	15.6	60	
						500	700	10.9	65	
						350	500	7.4	67	
2000 lm	●	●	●	●	98	1400	2000	42.1	47	L80/C3 50K
						1050	1560	30.2	52	
						700	1110	19.5	57	
						500	800	13.6	59	

STANDARD:

ARTIST:

Colour Consistency - Initial

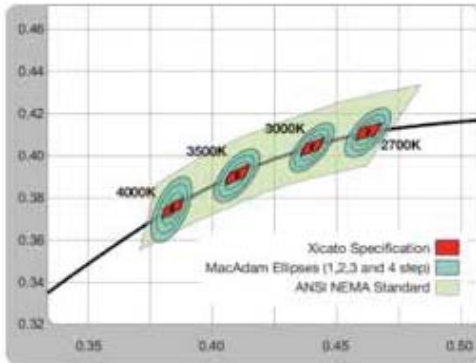

Colour Consistency - Initial

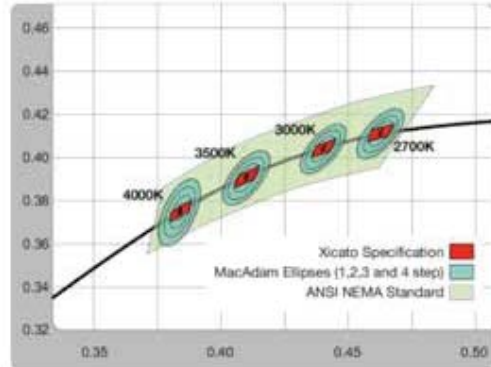

Colour Consistency - Maintained

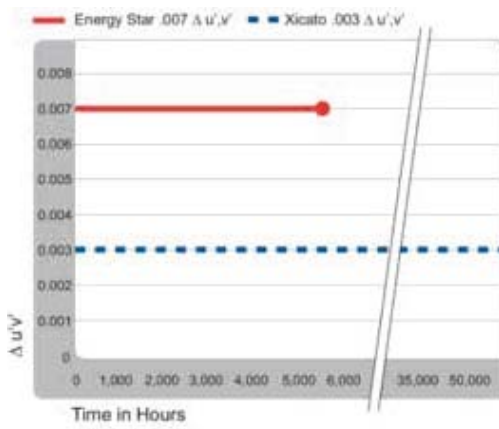

Colour Consistency - Maintained

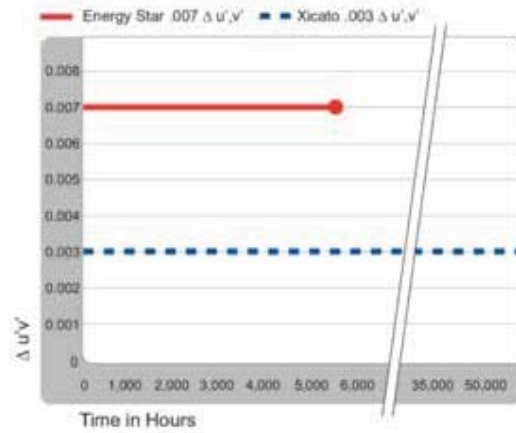

Spectral Power Distribution

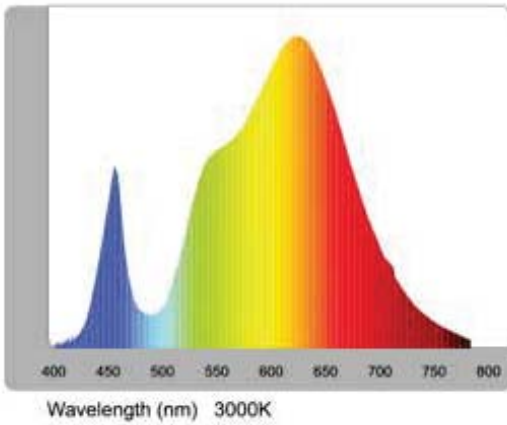

Spectral Power Distribution



STANDARD:

Colour Rendering Index (3000K Typical)

Ra	R1	R2	R3	R4	R5	R6	R7	R8	R9	R10	R11	R12	R13	R14	R15
83	82	89	95	84	82	87	86	65	16	64	79	58	81	93	75

ARTIST:

Colour Rendering Index (3000K Typical)

Ra	R1	R2	R3	R4	R5	R6	R7	R8	R9	R10	R11	R12	R13	R14	R15
98	98	99	98	98	98	97	98	98	98	99	98	88	98	98	98

70mmø

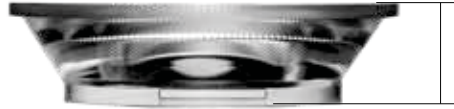
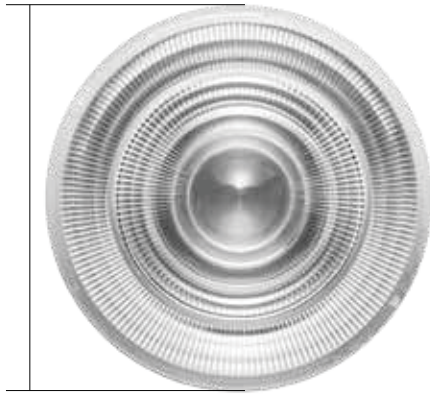

17.50mm

Note: (1) All the results of analysis are based on 0 degrees of elevation.
 (2) Tolerance: ±10%.
 (3) Led Luminous Flux(lm): 651(±5%).

Part Number	FWHM	Field Angle*	cd / lm	IES File
LL01CR-CEN12L02	14.3	30.1°	8.1	Download
Beam Pattern	Candela Distribution	Illuminance Distribution		
Part Number	FWHM	Field Angle*	cd / lm	IES File
LL01CR-CEN24L02	24.9°	51.8°	2.8	Download
Beam Pattern	Candela Distribution	Illuminance Distribution		
Part Number	FWHM	Field Angle*	cd / lm	IES File
LL01CR-CEN38L02	38.1°	71.4°	1.3	Download
Beam Pattern	Candela Distribution	Illuminance Distribution		

*The Field Angle is the angle between the two directions opposed to each other over the beam axis for which the luminous intensity is 10% that of the maximum luminous intensity.
 *This testing result is obtained through testing the popular rank LED samples which provided by the original manufacturer. Hence, the testing results would be varied as the users choose same LED model but different rank.

Product Type
 Optical Systems for COB LEDs
Product Diameter
 (d) 051 - 060
Beam
 Ultra Wide Beam



Product Height
 (h) 041 - 050

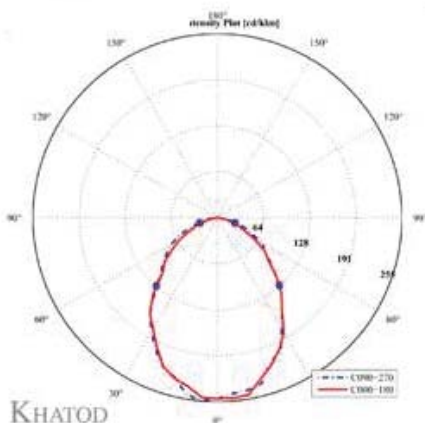

IES File: [Download](#)

Product Type
 Optical Systems for COB LEDs
Product Diameter
 (d) 051 - 060
Beam
 Wide Beam



Product Height
 (h) 041 - 050

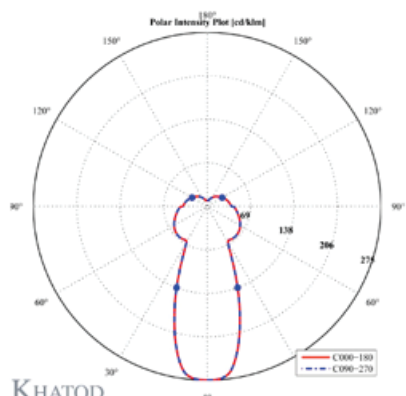

IES File: [Download](#)

KHATOD