



product number	product name	product designation	valid from	version
<b>10.273</b>	<b>CRD400 INS</b>	<b>Casambi LED-/Retrofit Dimmer 380 VA</b>	<b>H2</b>	<b>F1.5</b>

Dokument Version: 20231107

## Manufacturer's address and contact details

Address **MTC maintronic GmbH**  
 Carl-Zeiss-Straße 10  
 D-97424 Schweinfurt/Germany

Contact details  
 E-Mail [info@maintronic.com](mailto:info@maintronic.com)  
 Web [www.maintronic.com](http://www.maintronic.com)  
 Phone 0049 9721 7766-0

# Table of Contents

<b>1. Notes to the instruction. CRD400 INS</b>	<b>3</b>
1.1 Applicable documents	3
1.2 Usage	3
1.3 Safety information	3
1.5 Used symbols	4
1.6 Storage	6
1.7 Warranty and liability	6
1.8 Service and support	6
1.9 Disposal	6
<b>2. Safety . CRD400 INS</b>	<b>7</b>
2.1 General safety information	7
2.2 Intended use	9
2.3 Not-intended use	10
<b>3. Functions . CRD400 INS</b>	<b>11</b>
3.1 Performance characteristics	11
3.2 Features	11
3.2 Sicherheitsfunktionen	12
<b>4. Technical data . CRD400 INS</b>	<b>13</b>
<b>5. Installation . CRD400 INS</b>	<b>14</b>
5.1 Considerations and planning	14
5.2 Mechanical installation	16
5.3 Electrical installation	18
<b>6. Commissioning . CRD400 INS</b>	<b>20</b>
6.1 Operation with Casambi	20
6.2 Commissioning	20
6.3 Calibration	22
<b>7. Operation . CRD400 INS</b>	<b>25</b>
7.1 Notes for operation	25
7.2 Sensors and parameters	27
7.3 Dimming characteristics	29
7.4 Dimming Curve	30
7.5 LED flashing pattern	32
7.6 Operation with app	33
7.7 Operation with Push-button input	35
<b>8. Troubleshooting . CRD400 INS</b>	<b>36</b>
8.1 Reset to factory default settings	36
8.2 Unpair devices from network	37

# 1. Notes to the instruction. CRD400 INS

## 1.1 Applicable documents

This document contains all the necessary information for using this product.  
Please refer to this document in partial instructions (such as installation instructions).

## 1.2 Usage

This manual describes everything necessary for the safe and efficient use of the device. The manual is an integral part of the product and must be handed over to the end customer.  
Please note that earlier versions of the product may differ in programming, operation and behavior and may not support all the features described here.

Before installation, commissioning and operation, read this manual and pay attention to the warnings for safe handling, which are marked as follows:

## 1.3 Safety information

### DANGER



The signal word "DANGER" indicates an imminent danger. If not avoided, death or serious injury will result.

### WARNING



The signal word "WARNING" indicates a possibly imminent danger. If it is not avoided, death or very serious injuries may result.

### CAUTION



The signal word "CAUTION" indicates a possibly imminent danger. If it is not avoided, slight or minor injuries may result.

### CAUTION











The signal word "CAUTION" indicates a situation that can lead to material damage. Either to the product itself or to other objects in the environment.





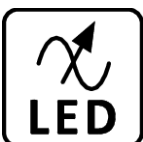
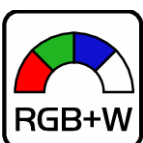

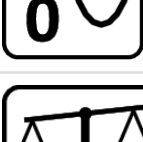

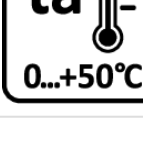
### NOTE

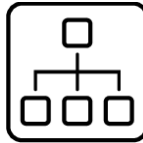
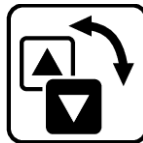









The signal word "NOTE" indicates tips and recommendations to help you get the most out of the product.

## 1.5 Used symbols



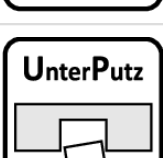





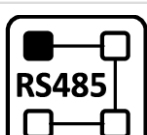

Icon	Description
	The number indicates the number of output channels of the device
	The number indicates the number of equipped push-button inputs
	Max. output current per channel
	Dimmed channel
	LED dimmer
	RGB+W color mixing
	Dims RLC loads R = resistive loads L = inductive loads (conventional transformers) C = capacitive loads (electronic transformers)
	Zero-cross switch - Device powers up or down by zero crossing of the sinewave
	Weight in gramm
	Temperature ambient (ta)
	0...+50°C

Icon	Description
	Astro function - control scenes through sunrise and sunset
	Group devices - create groups for joint control
	Logical inverting of channels. e.g. for a blind up - down or CH1 and CH2
	Timer function - execute time-controlled automated functions
	Scene control - save individual fixed images as scenes or create a chaser with an animation
	Type of protection
	Protection class II - protection through double insulation
	Protection class III - protection through supplied from a separated extra-low-voltage
	Wireless protocol Casambi
	DALI protocol interface
	DALI protocol interface with device type 6

	Temperature critical (tc)
	Powersupply AC - the voltage details either refer to a fixed voltage or a working range e.g. 100 to 240 V AC
	Powersupply DC - the voltage details either refer to a fixed voltage or a working range e.g. +10 to 24 V DC
	Powersupply DC - battery possible
	Powersupply - powered from DALI
	The number indicates how much space (in TE) the device takes up on a DIN rail
	Flush mouted housing - in installation boxes or in devices of protection class II
	Installation housing - installation in ceiling, wall or luminaire

**NOTE**

 The symbols explained here show the technical data of the devices. These symbols can be found in the technical documentation of the respective device.

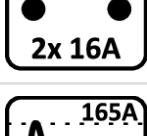
	DMX protocol interface
	DMX protocol interface with RDM
	RS485 interface
	Push-button input on mains voltage 230V AC
	Push-button input
	Wireless push-button input
	Wireless controll
	Wireless controll with gateway / repeater function
	Rollers and blinds function
	changeover relay Number indicates the amount of relays
	Switch Relay (normally open contact) Number indicates the amount of relays and 16A the switch current of the relay
	Relay with high inrush current - current peaks up to 165A for 20mS

## 1.6 Storage

Electrical devices are stored constantly at 10 to 25 degrees Celsius in dry storage rooms.

The devices must be protected from dust, moisture, splashing and dripping water.

## 1.7 Warranty and liability



Dieses Handbuch wurde mit größtmöglicher Sorgfalt erstellt, es sind dennoch Fehler und Irrtümer nicht vollständig auszuschließen. Die Firma MTC maintronic GmbH übernimmt keinerlei Haftung für Personen- oder Sachschäden, die sich aus Fehlern oder Irrtümern in dieser Bedienungsanleitung herleiten oder durch Nichtbeachtung von Sicherheitshinweisen.

Die Rechte von eventuell genannten fremde Firmennamen, Marken, Warenzeichen oder Logos liegen bei den jeweiligen Eigentümern.

## 1.8 Service and support

If you need special support beyond the information provided here, contact your distributor or the address in the Manufacturer Contact section. [Herstellerkontakt](#).

## 1.9 Disposal

Waste disposal	
	<p>In accordance with European Directive 2002/96/EC (it`s) not longer usable electronic devices and defective or used batteries (European Directive 2006/66EG) must collected separately and disposed by an environmentally sound recycling.</p>
	<p>This symbol indicates that electrical and electronic equipment must be disposed of separately from normal waste at the end of its operational lifetime.</p>
<p>Should these product are no longer be useable, the user is required by law to dispose of old appliances separately from their household waste e.g. at a local authority collection point or recycling center.</p>	

## 2. Safety . CRD400 INS

### 2.1 General safety information

#### Qualified personnel

##### DANGER



The unit must only be installed and serviced by a proven electrician specialist, in accordance of all relevant regulations, safety and accident prevention directives of the country.

Be sure that the existing mains voltage corresponds with the specified operating voltage before operating the device.

Risk of electric shock. Do not operate the device without a cover. Even when switched off, voltage may be present at the outputs. When working on the device or connected loads, always disconnect the upstream fuse from the power supply.

Apply the "Five Safety Rules" (DIN VDE 0105, EN 50110):

1. Disconnect
2. Secure against being switched on again
3. Determine absence of voltage
4. Ground and short circuit
5. Cover or isolate nearby live parts

Only install the device in places with a good ventilation and without humidity or high temperatures. Do not expose the unit to rain or snow. Do not operate the unit near heat sources, e.g. radiators.

If any of the following occurs, do not operate the device without first checking it:

- if objects have fallen or liquid has been spilled into the unit.
- if the device has been exposed to rain.
- if the device does not operate normally or with altered characteristics. if the device has been dropped or has a broken housing.

For cleaning only use a dry, soft cloth, by no means liquids.

#### Working on electrical installations

##### WARNING



*Dangerous voltages in live installations, cables, plugs ...*

#### Device-specific notes

##### WARNING



*There is a risk of dangerous voltages being applied to the device (DALI, not SELV). If a person touches live parts, an electric shock can cause serious injury or even death.*

##### WARNING



For your own safety, read all instructions and information in this manual carefully before initial operation. Keep this manual for future reference.

The instructions are an integral part of the product and must be handed to the end customer.

All information and instructions in this manual must be observed completely and in detail. The manufacturer is not responsible for any direct or consequential damage that results from disregarding any information in this manual.

### Waste disposal



In accordance with European Directive 2002/96/EC (it`s) not longer usable electronic devices and defective or used batteries (European Directive 2006/66EG) must collected separately and disposed by an environmentally sound recycling.

This symbol indicates that electrical and electronic equipment must be disposed of separately from normal waste at the end of its operational lifetime.

Should these product are no longer be useable, the user is required by law to dispose of old appliances separately from their household waste e. g. at a local authority collection point or recycling center.

### CE-marking



The devices comply with the EU directives applicable at the time they are placed on the market.



## 2.2 Intended use

The device is a digital **leading/trailing edge** phase dimmer with automatic load detection in an INS installation housing.

The dimmer supports control via **button input (PushButton Input)** and via Casambi.

Module Version	Installation location	Description
INS	Installation	for installation in ceilings, walls or other cavities (pay attention to fire protection)

Das Gerät ist für Folgendes bestimmt:

- dem Betrieb gemäß den aufgeführten technischen Daten
- die Installation in trockenen Innenräumen
- die Nutzung mit den am Gerät vorhandenen Anschlussmöglichkeiten

### HINWEIS



Zur bestimmungsgemäßen Verwendung gehört auch die Einhaltung aller Angaben dieser Nutzerinformation.

### HINWEIS



Bitte beachten Sie, dass sich vorangegangene Versionen des Produktes in Programmierung, Bedienung und Verhalten unterscheiden können oder nicht alle hier beschriebenen Funktionen unterstützt werden!

1. Vergleichen Sie die Angabe der unterstützten Geräteversion dieses Handbuchs (dieser Dokumentation) mit der Angabe der Version auf dem Geräteaufkleber. Die Angabe zur Version findet sich auf dem Geräteaufkleber rechts unten:

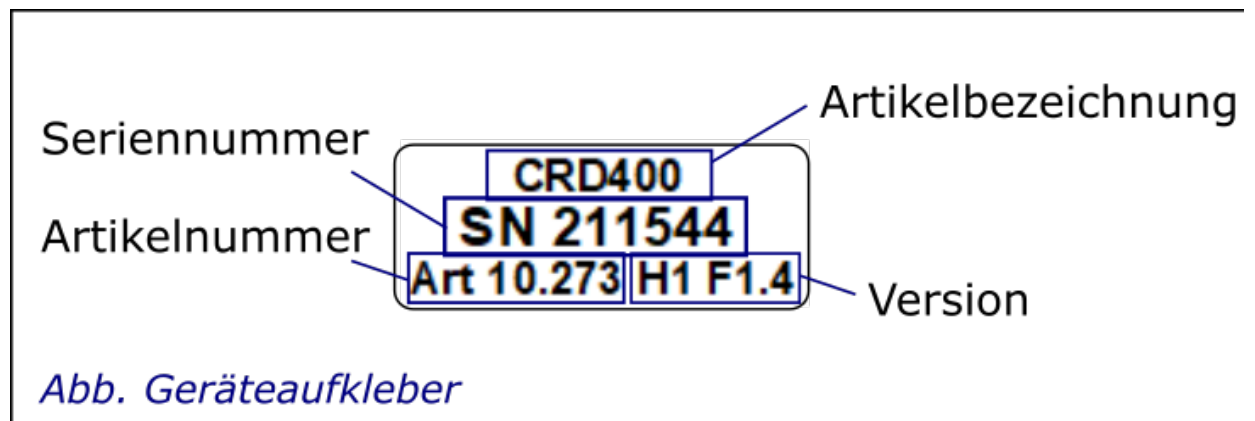

2. Stimmt die Version Ihres Gerätes nicht mit der im Handbuch unterstützten Version überein, beschaffen Sie sich das zugehörige Handbuch und verfahren nach der Anleitungen dort.

## 2.3 Not-intended use

Jede andere Verwendung gilt als bestimmungswidrig und kann zu Personen- und Sachschäden führen, insbesondere:

- eigenmächtige bauliche Veränderungen
- Reparaturen
- Einsatz im Außenbereich
- Einsatz in Nasszellen

[MTC maintronic GmbH](#) haftet nicht für Schäden, die durch bestimmungswidrige Verwendung des Geräts entstehen. Das Risiko hierfür trägt allein der Benutzer/Betreiber.

## 3. Functions . CRD400 INS

### 3.1 Performance characteristics

The device can be controlled via the Casambi app, available for iOS and Android. Another optional operation ist given by the push button input.

Casambi app automatically identifies the device and can be integrated into existing networks. All functions triggered by the buttons are individually configurable.

As soon as the device is added to your network, it can be operated. Groups can be formed, scenes and timers can be created.













You can find all Casambi app related help on the official Casambi support sites at: <https://support.casambi.com>.

#### Product description

Digital leading- / trailing edge phase cutting dimmer with automatic load detection for a single dimmed phase. Equipped with an additional push button input which extends the dimmer with a fast analogue control. Local control is so much easier.

For help with the configuration and operation of Casambi, please also refer to the official Casambi help at: <https://support.casambi.com/>.

### 3.2 Features

	 mains	 dimmer	 rated power	 channels	 installation type
<b>Control</b>		 1x PB Input			
<b>Temp enviroment and electrical ...</b>	 0...+50°C	 +70°C	 Class II	 IP20	
<b>Assembly end Shipping</b>	1 unit retail box	 100 g			

## 3.2 Sicherheitsfunktionen

### Derating

The maximum dimmer load is possible up to an ambient temperature of 50 °C. Between 50 and 70 °C ( $t_{a \text{ max allowed}} = t_{\text{critical}} = t_c$ ) the maximum power decreases to 0 Watt.

The specified max. power rating applies to installation in a sufficiently ventilated location. In case of lower heat dissipation, e.g. in cavity walls, flush-mounted/ junction boxes, as well as in case of mutual heating of several devices, the max. power rating is reduced accordingly.

In case of overtemperature automatically derating takes place, which means the power will be reduced depending on the temperature. Status-LED is indicating over temperature and the brightness of the lamps decreases.

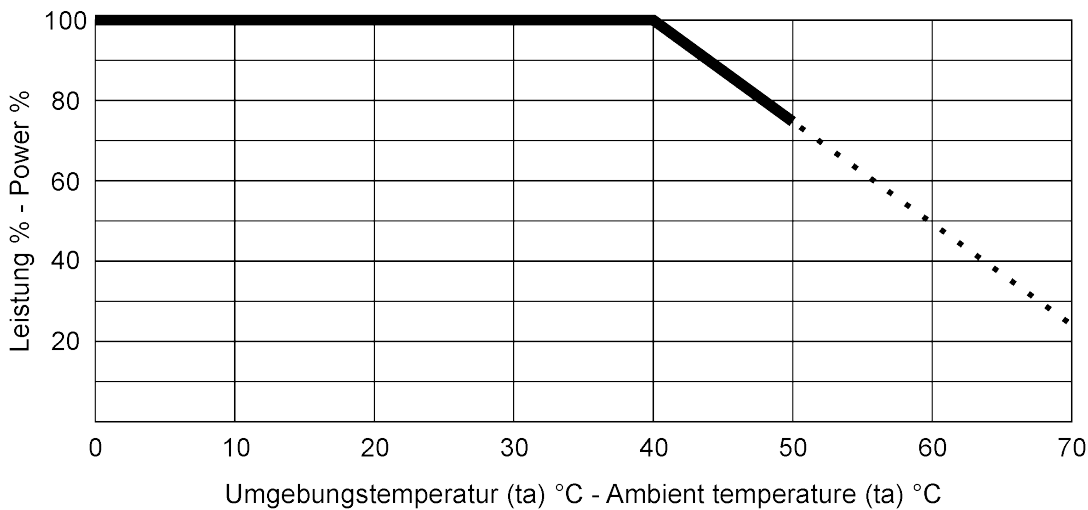

Fig.: Derating curve of the CRD400 INS

Temperatures higher than 50°C are not specified in the approved ambient temperature.

However, the dimmer does not switch off hard and continues to adjust downwards even at higher temperatures.

## 4. Technical data . CRD400 INS

Specification	CRD400 INS	Item no. 10.273
Power supply		220 ... 240V AC 50/60Hz
Rated power		4 ... 380VA
Output power		0 ... +40°C Connected load 100% +40 ... +50°C Note derating
Power consumption	on idle / switching	0,6W / 1,8W at full load
Terminals, Wiring	Screw terminal wiring	single-wire: 0,2 ... 4 mm <sup>2</sup> fine-wire: 0,2 ... 2,5 mm <sup>2</sup>
Striping length	Striping length	6 mm (+/- 0,5 mm)
Tightening torque	Tightening torque	max. 0,2 Nm
Operation- and indication units		Device Button, Status-LED
Protection circuits		Short circuit with auto restart, over temperature (derating), over current, over Voltage
Type of protection		IP20, Class II
Temperature ambient (ta)		0 ... +50°C
Temperature critical (tc)		+70°C
Humidity		5 - 80% non-condensing
Casambi	App available for Android and iOS	Bluetooth Low Energy (BLE)
Alternate control	Casambi enabled push-button input	230V AC
Approbation		CE
Installation		Installation housing Licensed under DM/053379 of Tridonic
Mounting		Installation in ceiling, wall or luminaire
Dimensions (height x width x depth)		29,5 x 51x 101,5 mm
Weight		84g
Housing		plastics, white
Customs tariff number		85365080
Co-applicable documents		Installation instructions; manual

# 5. Installation . CRD400 INS

## 5.1 Considerations and planning

A Casambi network is a mesh network and every participant (dimmer, switches, etc.) extend the reach of the network.

Casambi is based on the energy-saving Bluetooth 4.0 standard. If a module is nearby, all luminaires within range of this module can be controlled.

Bluetooth has a range of up to 20 m. Plan your network in such a way that the radio coverage of the modules is guaranteed with each other and no dead spots arise.



If there are gaps in the network or modules are positioned at the limit of the radio coverage, strange errors can sometimes occur.

Before putting the device into operation, make sure that the correct power supply and power class is selected.

Dimmer for brightness control of illuminants such as incandescent lamps, high-voltage halogen lamps, dimmable LED lamps for 230 V.

- 1-channel universal dimming actuator
- With a pre-fuse of max. 16A
- Installation housing INS
- Operate the device (Operation) only in dry indoor rooms (below 80 % humidity, non condensing)
- 68 mm pitch circle. (68 mm hole)

## Power calculation depending of the used lighting source

Load type	cutting method	Percentual rated output power
Ohmic	trailing edge 	100 %
LED	trailing edge 	approx. 80 %
copper transformer	leading edge* 	approx. 20 %

\* leading edge is **mandatory** (only) for copper transformers

### Example:

A rule of thumb calculation for LEDs with internal power supply:

- Given is trailing edge as cutting method
- 20x LED 7.5 watts = 150 watts (nominal power of the LEDs)
- plus additional charge 20% (for capacitive parts of the LED load characteristic)

Result: 180 watts as total power is required.

## 5.2 Mechanical installation

### Dimensions

Installation housings for dry interiors for installation or mounting in walls, ceilings or other cavities.

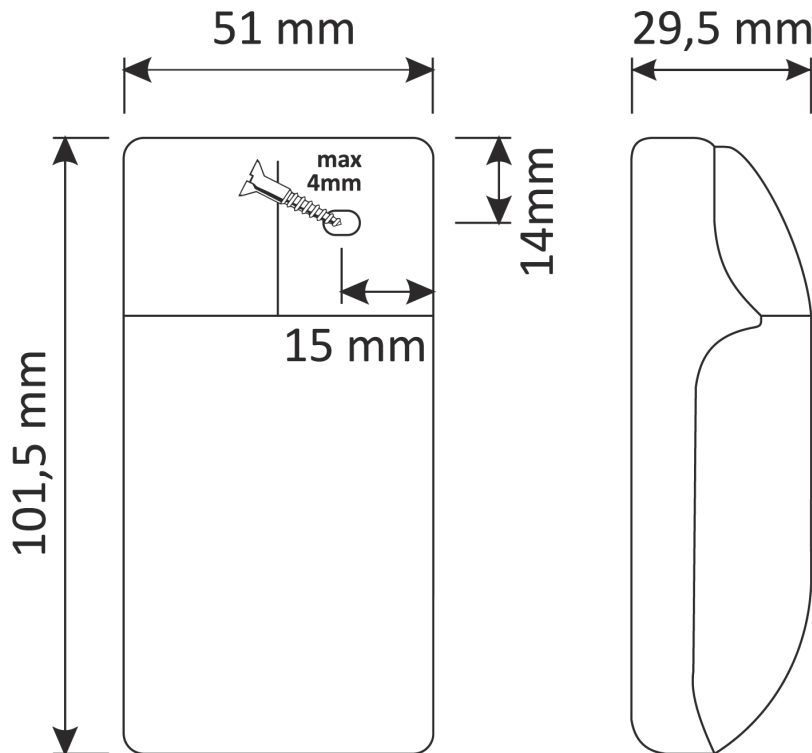

### Installation

Due to the compact dimensions and the rounded shape, an easy installation is possible for all feed-through openings from 68 mm pitch circle.

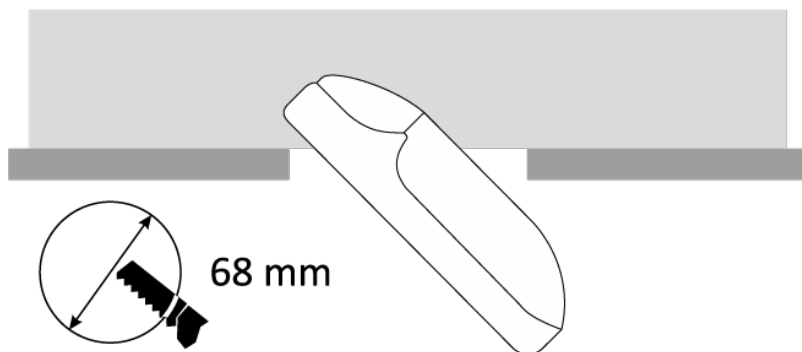

The integrated strain relief and terminal cover eliminates additional wiring and junction box.





## 5.3 Electrical installation



### Connections

1		Output, dimmed phase 230V AC
2	N	Neutral conductor
3	N	Neutral conductor
4	L	Input mains, phase 230V AC
5	N	Input push button, neutral N
6	L	Input push button, phase L - 230V AC

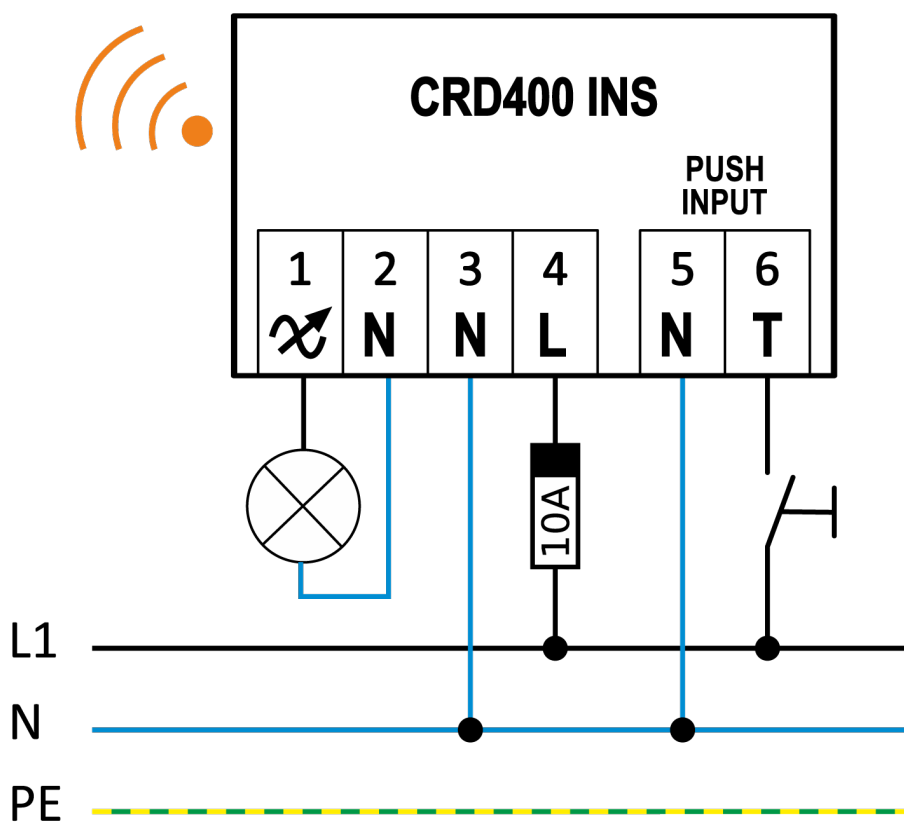
### Connection diagram

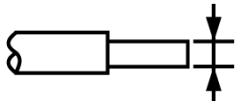
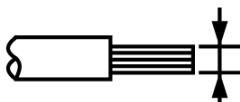

### Wiring

	0,2...4mm <sup>2</sup> single wire
	0,2...2,5mm <sup>2</sup> fine wire 0,5...2,5mm <sup>2</sup> fine wire with ferrule
	6mm

## Operating elements

### Elements

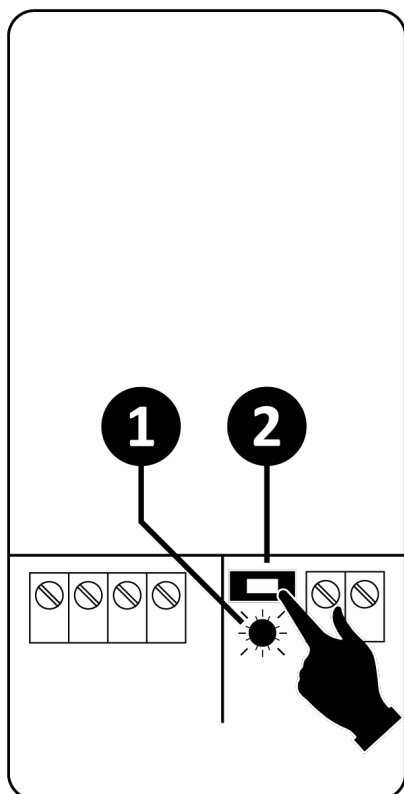

1	Status-LED
2	Device-button

## 6. Commissioning . CRD400 INS

### 6.1 Operation with Casambi

The device can be controlled via the Casambi app, available for iOS and Android. Another optional operation ist given by the push button input.

Casambi app automatically identifies the device and can be integrated into existing networks. All functions triggered by the buttons are individually configurable.

As soon as the device is added to your network, it can be operated. Groups can be formed, scenes and timers can be created.

You can find all Casambi app related help on the official Casambi support sites at: <https://support.casambi.com>.

### 6.2 Commissioning

To make sure that the functionality of the device is up to date, first of all you have to check if a new firmware is available.

#### Update firmware

1. Open Casambi App
2. Go to nearby devices
3. Scroll down
4. Check for updates
5. If an update is available, please install

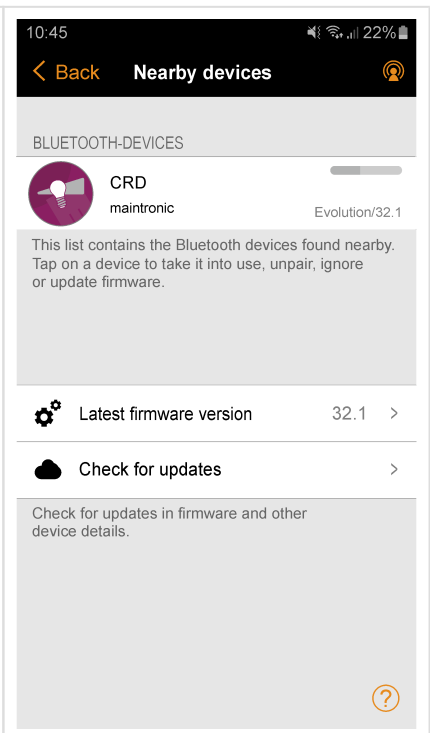

## Add a device to a network

Casambi App automatically identifies the device and can be integrated into existing networks. All functions triggered by the buttons are individually configurable.

The following steps are necessary for this purpose:

1. Open Casambi App
2. Choose existing network or create a new network
3. Go to nearby devices
4. Add found maintronic device to a network

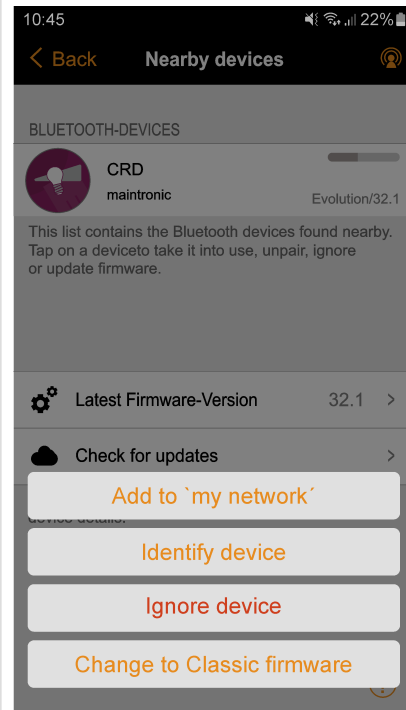

## 6.3 Calibration

### Measuring (AdaptivDIM)

When commissioning for the first time, the dimmer will calibrate accordingly to the connected load (duration max. 60 sec.).

In factory default state or after a reset, the calibration starts with the Automatic mode, which means AdaptiveDIM automatically determines the stable lowest brightness, the ideal characteristic curve and the cutting method during the initial setup.

After changing the type or number of luminaires, the device must be recalibrated.

On Casambi enabled devices the measurement process can be done on the fly via the APP.

#### NOTE



During the measurement the luminaires may flicker. This is system-immanent and not a defect of the device.

The calibration must be completed and shall not be interrupted by switching off the device, otherwise the procedure must be repeated.

### Measure mode

A measurement mode must be selected in order to determine the phase cutting method.

A calibration is performed during initial commissioning and can be triggered manually via the Casambi app if required.

In addition, the following steps are necessary:

1. Open Casambi App
2. Open dimmer settings with double click
3. Set Unlock/Lock settings to unlocked
4. Select a measurement method under parameter Measure Mode
5. Select Start measurement
6. The connected LED will now be measured again and confirmed with Done!

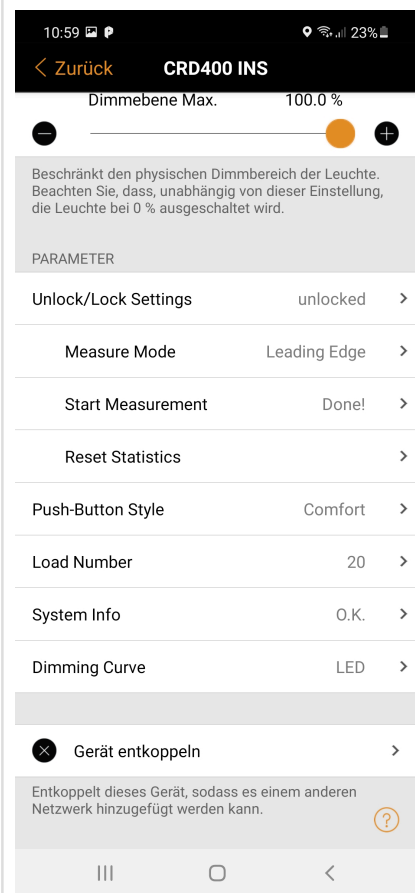

Measure modes	
Automatic	Automatic measurement determines automatically phase cutting mode and dimming curve for best possible dimming result. Hint: With the exception of copper transformer, trailing edge phase cutting mode is used.
Trailing Edge	Applicable on LED luminaires or incandescent lamps, the appropriate dimming curve is set, trailing edge phase cutting mode is used.
Leading Edge	If a copper transformer is dedected, leading edge phase cutting mode is used.
Zero Cross Switch	If the load is not or insufficient dimmable or this mode is selected manually, mains is switched ON and OFF at zero voltage crossing.

The cutting method with which the dimmer works can be displayed under Settings > Sensors > Leading Edge:

- Leading Edge = 0 > Trailing edge phase cut is used
- Leading Edge = 1 > Leading edge phase cut is used

The screenshot shows the 'SENSOREN' (Sensors) screen for the 'CRD400 INS' device. The status bar at the top shows the time 10:59, signal strength, Wi-Fi, and 23% battery. The screen title is '< Zurück CRD400 INS'. Below the title, the sensor data is displayed in a list format:

SENSOREN	
Total consumed	0 Wh
Current Power	0 W
Load Current	20 mA
Temperature	0 °C
On-Time Dimmer	10 h
On-Time Load	0 h
On-Cycles Device	0
On-Cycles Load	3
Phase Angle	0 °
System Status	0
Leading Edge	0

At the bottom of the screen, there is a navigation bar with three icons: a hamburger menu, a square, and a back arrow. A question mark icon is visible next to the 'Leading Edge' value.

## Load numbers - max. number of luminaires of the same type

In order to optimally use the dimmer and to see how many luminaires of the same type can be used, it is possible to determine the load number of the luminaire. To do this, measure with a single luminaire.

The determined load number can be found in the Casambi APP under Parameters, it shows the quantity of possible luminaires of the same type.

### NOTE



A load number is only available for lamp type LED, the integrated load number display is a recommendation and helps to determine the maximum number of luminaires.

Please also refer to the note on " Power calculation retrofit dimmer" in chapter 5.

In addition, the following steps are necessary:

1. Open Casambi App
2. Open Dimmer settings with double click
3. Set Unlock/Lock settings to unlocked
4. Select Load number  
The load number is displayed next to the parameter
5. If the result is N/A please measure again with several lamps  
 $\text{Number of connected illuminants} \times \text{displayed load number} = \text{quantity of possible illuminants}$

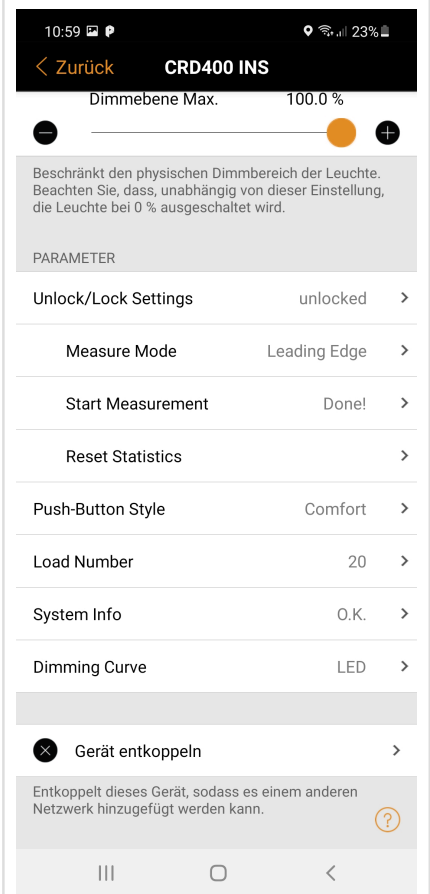



## 7. Operation . CRD400 INS

### 7.1 Notes for operation

#### Operation with Casambi

The device can be controlled via the Casambi App, available for iOS and Android. Another optional control is given by the push-button input.

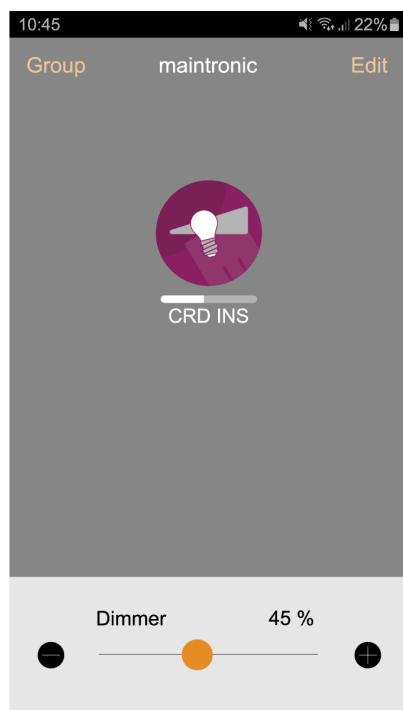

#### Operation with device-button

The device button (1) has the same priority as the Casambi App, the last command (action) wins.

Function device-button	Keystroke
Switch On- / Off	short press
Dim the last stored brightness	
Dimming Up and Down (Start at Min Level)	long press
Switching to Max Level	2x short press

## Operation with push-button input

The device is equipped with a push-button input (Pin 5 u. 6), push-buttons with mains potential can be connected to this input. A push-button has the same priority as the Casambi App, the last one wins. Note that the N must be connected to pin 5.

All wiring and the pushbuttons must be insulated for the maximum supply voltage. Ensure the appropriate contact protection after installation. All push-buttons of the well-known switch manufacturers are suitable.

Please see the notes to the push-button styles.

## Push-button style

Through the parameter Push-button style the functionality of the button inputs are defined.

To change the push button style, proceed as shown below

- Open Casambi App
- Double tap on the device icon
- Scroll down to parameter
- Tap on Push-button style
- Choose parameter  
(Siehe nachfolgende Liste)

Push Button style - possible parameters	
Comfort	Casambi standard operations plus additional functions:
Standard	Standard Casambi Push button input
	Behavior like a standard Casambi input with Casambi standard operations

## 7.2 Sensors and parameters

### NOTE



In the Casambi world they are the terms **sensors**, **parameters** and **information**. Each of the terms stands for a specific type of value.  
Here is the explanation:

Name	Meaning	Examples	Type
<b>Sensors</b>	display static values or technical-physical values of the environment	Consumption / Number of switching cycles	read only
<b>Parameters</b>	settings to achieve the desired functions or behavior	State after switching on: last value	writable
<b>Information</b>	show values like manufacturer, model, or even detailed operating states of the device	RSSI: 78 dBm (radio reception quality)	read only

### Parameter

Parameter name	Description	Value range	Entity	Default
Unlock/ Lock Settings	To unlock the following parameters, this value must be set to unlocked	locked unlocked		locked
Measure Mode	Here a measure mode can be preset with which a new calibration starts.	Automatic Trailing Edge Leading Edge Zero Cross Switch		Automatic
Start Measurement	Start new calibration			
Reset statistics	delete statistics			
Push-Button-Style	Behavior of the device button <ul style="list-style-type: none"> <li>Comfort - Casambi functions plus Comfort functions like e.g. double click = 100%; dimming; long key; load memory level function</li> <li>Standard - Standard Casambi Push button input Behavior like a standard Casambi input</li> </ul>	Comfort Standard		Comfort
Load Number	Display load number - max. illuminants of the same type are displayed	0...	digits	

System info	System status is displayed through a text. If there is no error, the text is "O.K.". If an error is present, the corresponding text is displayed. If several errors are present, the text of the error with the highest priority is displayed.		digits																																	
	<table border="1"> <thead> <tr> <th>Error</th> <th>Text</th> <th>Value</th> <th>Priority</th> </tr> </thead> <tbody> <tr> <td>No error</td> <td>O.K.</td> <td>0</td> <td></td> </tr> <tr> <td>Load output is open</td> <td>Open</td> <td>1</td> <td>1</td> </tr> <tr> <td>Over temperature is active</td> <td>Overtemp</td> <td>2</td> <td>2</td> </tr> <tr> <td>Load output has overvoltage</td> <td>Overvolt</td> <td>4</td> <td>3</td> </tr> <tr> <td>Load output has a short-circuit</td> <td>Short</td> <td>8</td> <td>4</td> </tr> <tr> <td>Shutdown by over temperature</td> <td>SD temp</td> <td>16</td> <td>5</td> </tr> <tr> <td>Shutdown by short-circuit</td> <td>SD short</td> <td>32</td> <td>6</td> </tr> </tbody> </table>	Error	Text	Value	Priority	No error	O.K.	0		Load output is open	Open	1	1	Over temperature is active	Overtemp	2	2	Load output has overvoltage	Overvolt	4	3	Load output has a short-circuit	Short	8	4	Shutdown by over temperature	SD temp	16	5	Shutdown by short-circuit	SD short	32	6			
Error	Text	Value	Priority																																	
No error	O.K.	0																																		
Load output is open	Open	1	1																																	
Over temperature is active	Overtemp	2	2																																	
Load output has overvoltage	Overvolt	4	3																																	
Load output has a short-circuit	Short	8	4																																	
Shutdown by over temperature	SD temp	16	5																																	
Shutdown by short-circuit	SD short	32	6																																	
Dimming Curve	The dimming curve used can be selected, by default the linear curve is used. To get a different dimming behavior, the dimming curve can be selected. The Casambi curves 3 and 4 are intended when several dimmers from different manufacturers are operated together. More information  <a href="#">See dimming curve</a>																																			

## Sensors

Sensor name	Description	Default	Value range	Entity
Total consumed	Total consumed energy in Wh	0	0 ... 1.000.000	Wh
Current Power	Power currently consumed by the load	n.a.	0 ... 1.000.000	Wh
Load Current	Actual load current in mA	n.a.	0 ... 1.000.000	mA
Temperature	Momentary temperature at the measuring point (inside)	n.a.		°C
On-Time Dimmer	Number of operating hours device	permanant	0 ... 1.000.000	h
On-Time Load	Number of operating hours lamp/load	0	0 ... 1.000.000	h
On-Cycles Device	Number of power-ups device	permanant	0 ... 1.000.000	cycles
On-Cycles Load	Number of power-ups lamp/load > Brightness 0	0	0 ... 1.000.000	cycles
Phase Angle	Phase Angle = Current phase angle of the dimmed output <ul style="list-style-type: none"> <li>0° &gt; Load is switched off</li> <li>1-179° &gt; Phase cut is applied</li> <li>180° &gt; Load is switched permanently on</li> </ul>	n.a.	0 ... 180°	degree
System Status	System Status - Error Code The parameter "System info" is derived from this error code.	-	0, 1, 2, 4, 8, 16, 32	number
Leading Edge	<ul style="list-style-type: none"> <li>0 &gt; Trailing edge phase cut is used</li> <li>1 &gt; Leading edge phase cut is used</li> </ul>	n.a.	0, 1	digit

n.a. = not applicable

## 7.3 Dimming characteristics

### Short circuit

In case of a short circuit, the unit switches off the output. Every 30 seconds, the unit tests whether the short circuit has been eliminated. If it has, the unit restarts automatically. If the fault is still present after 5 min, the unit is switched off.

Instruction: Switch off the unit and eliminate the short circuit.

### Noise emission

It may occur that the dimmers cause acoustic noise when they are used under unfavourable conditions or with certain luminaires. Our dimmers are extremely low noise design, noise is always an indicator for the overall quality of the used luminaires. Try to change luminaires with other / better characteristics.

### Flickering

The device works properly under regular power quality conditions. Flicker or other visual effects may occur in case of insufficient mains conditions like fluctuations, Jitter or also power control signals. Power grid immanent effects are not a defectives of the device.

Check your local grid.

## 7.4 Dimming Curve

The used dimming curve can be selected, per default the linear curve is used. To achieve a different dimming behavior, the dimming curve can be selected. The Casambi curves 3 and 4 are intended when several dimmers from different manufacturers are operated together.

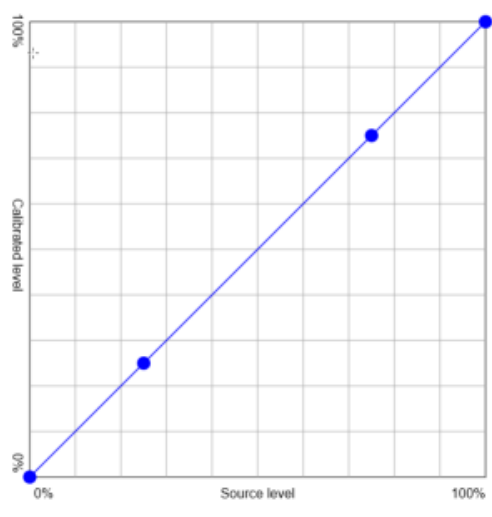
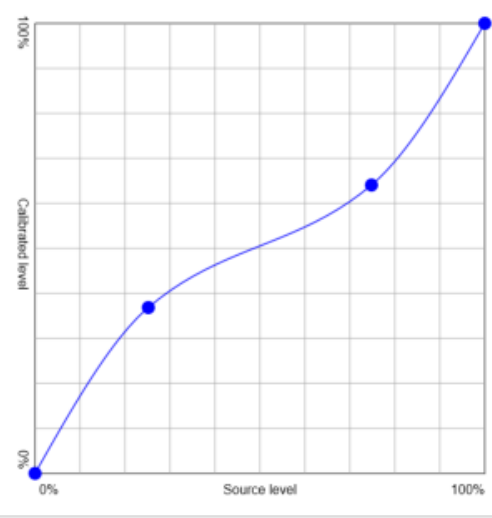
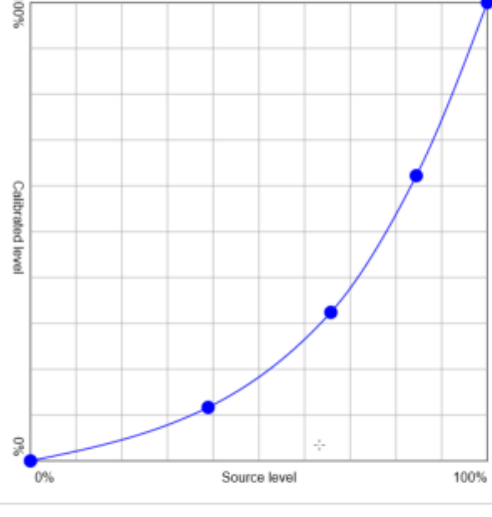
Mode	Dimming curve	Value	Type
linear	 <p>A graph showing a linear relationship between source level and calibrated level. The x-axis is labeled 'Source level' and ranges from 0% to 100%. The y-axis is labeled 'Calibrated level' and ranges from 0% to 100%. A straight blue line connects the origin (0%, 0%) to the top-right corner (100%, 100%). Three blue dots are plotted along this line at approximately 25%, 50%, and 75% source level.</p>	0	linear curve - default
LED	Picture added soon	1	maintronic custom curve
incandescent	Picture added soon	2	maintronic custom curve
Casmbi Standard	 <p>A graph showing a concave-up dimming curve. The x-axis is labeled 'Source level' and ranges from 0% to 100%. The y-axis is labeled 'Calibrated level' and ranges from 0% to 100%. A blue curve starts at (0%, 0%) and ends at (100%, 100%), curving upwards. Three blue dots are plotted along the curve at approximately 25%, 50%, and 75% source level.</p>	3	Casambi Compatibility mode
Casambi Log	 <p>A graph showing a concave-up dimming curve with a steeper slope at higher source levels. The x-axis is labeled 'Source level' and ranges from 0% to 100%. The y-axis is labeled 'Calibrated level' and ranges from 0% to 100%. A blue curve starts at (0%, 0%) and ends at (100%, 100%), curving upwards. Three blue dots are plotted along the curve at approximately 25%, 50%, and 75% source level.</p>	4	Casambi Compatibility mode



## 7.5 LED flashing pattern

LED flashing pattern	Description	Prolog-Pattern	LED-Pattern (max 50 Slots)	Mode	Farbe
Module start	Power-on		#####-----	once	green
Module standby	Output is switched off (Output level == 0)		# 59 x -	loop	green
Switched on	Output is switched on (Output level > 0)			permanent	green
Pushbutton input active	Control button is pressed		##-----#####--	loop	green
Programming mode	Button programming of minimal phase angle		#####-----	loop	green
Factory reset	Factory reset		#####- ##-#-	once	green
Number signage	Signalisation of system states				green
2 Hz 5/6	Performing load measurement				green
Error state 1	Over temperature is active	#####- #-----	##-----	loop	red
Error state 2	Over voltage is active	#####- #-----	##----##-----	loop	red
Error state 3	Short circuit is active	#####- #-----	##----##-----	loop	red
Fatal Error	Shutdown by over temperature or short circuit		#####- ##-#-	loop	red





## 7.6 Operation with app

In the Casambi app, there are various controls for the devices.

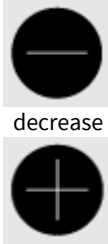
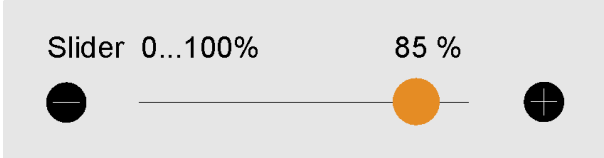
### Slider

<p>With a slider you can adjust the brightness of a dimmer (from 0 ... 100%) and in the case of a blind actuator, the position of the roller blind/blind from completely open (0%) to completely closed (100%)</p>	 <p>Dimmer 45 %</p>
<p>The position of the slider can be controlled via the controls</p>	 <p>decrease or increase</p>
<p>and infinitely variable adjustment via the handle</p>	 <p>Slider 0...100% 85 %</p>

### Toggle switch

<p>A toggle switch in the app acts like a conventional Switch and has two positions</p>	 <p>ON and OFF</p>
<p>The switch remains in its position until a new switching command comes</p>	 <p>Kippschalter - AN Kippschalter - AUS</p>

## Button

A button has no fixed position but is only active as long as the button is held.

Taster



## 7.7 Operation with Push-button input

### Open Switches

Push-button inputs can be individually assigned with desired functions. In order to do this, the following steps are necessary:

1. Open Casambi app and tap on „... More“
2. Open item „Switch“
3. Select device
4. Scroll down do Push-buttons
5. Choose your maintronic module with push-button inputs
6. For example program switch with single function
  - a. Select the item "Controls a luminaire"
  - b. Tap on "Luminaire"
  - c. Choose a device

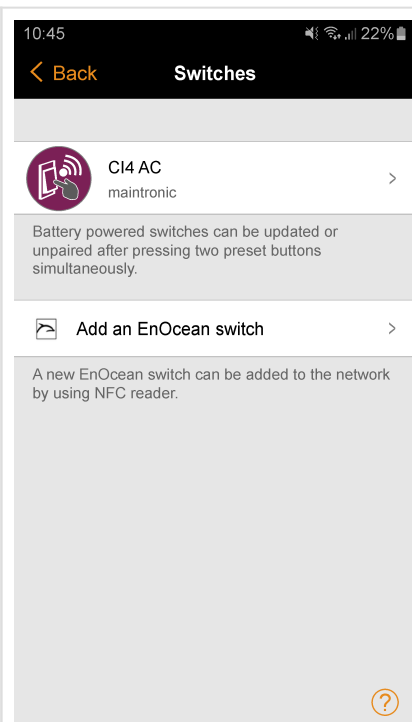

### Configure a button to a device

By default, the push-button is configured to itself. If another device or scene should be controlled, proceed as follows:

1. Proceed step 1-5 above
2. Select the item "Controls a luminaire"
3. Open an element
4. Open the "Element" item
5. Select the desired element

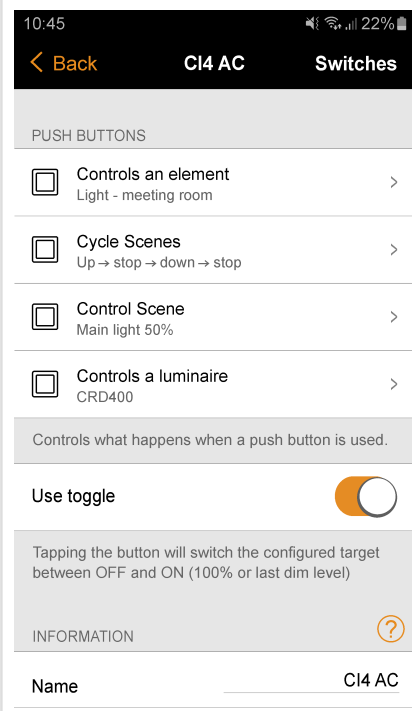

## 8. Troubleshooting . CRD400 INS

### 8.1 Reset to factory default settings

The dimmer can be reset via the device button and the settings will be restored to the factory default settings. For a reset, the device must not be paired with a Casambi network.

#### Step by step guide

1. Remove the device from any existing Casambi network.
2. Press the device button for 20 seconds
3. After 20 seconds the device will be reset and the LEDs will flash.
4. After the reset an automatic calibration takes place



#### NOTE

The following values are reset during a reset:

- Casambi Configuration
- Parameters are set to default values
  - Measure mode = Automatic
  - Push-Button-Style = Comfort
- Sensors values
  - Total consumed
  - On-Time Load
  - On-Cycles Load

The System Reset function is only active for 60 minutes after the device is switched on. To perform a reset after this time, the device must be restarted.

## 8.2 Unpair devices from network

### Unpair a device from an existing network

A device that is integrated into a Casambi network can be removed from the network again with the function "unpair device".

Ein Gerät, dass in ein Casambi Netzwerk eingebunden ist, kann über die Funktion Gerät entkoppeln wieder aus dem Netzwerk entfernt werden.

1. Devices nearby
2. Select device
3. Unpair device

A successful unpairing is indicated in the app.

By unpairing from a network, the parameters and settings of the device are removed.

### Unpair device from a network to which you no longer have access

To unpair a device to which you have physical access to from a network, you can use the function flick-unpairing.

To do this, the function "Allow flick-unpairing" must be activated.

1. Settings
2. Performance and safety
3. Activate "Allow flick-unpairing"

If the function is activated, proceed as follows to unpair the device from the network:

1. Devices nearby
2. Select device
3. Choose flick-unpairing

Either switch the device on and off for the duration of the unpairing or briefly disconnect the voltage.

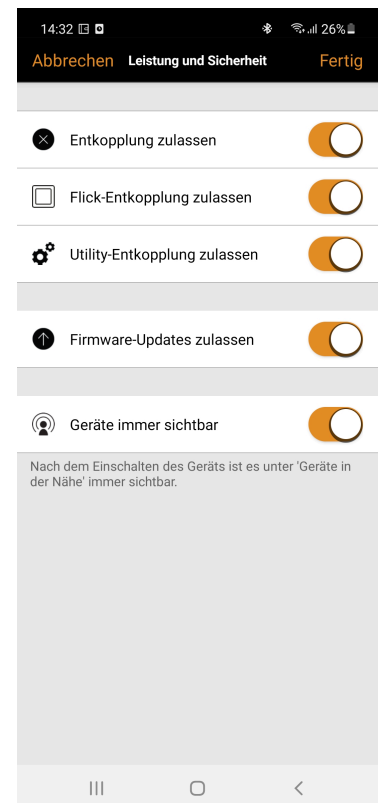

### Unpair device from a network when flick-unpairing is disabled

In the case that you no longer have access to the network and the security option "flick-unpairing" is disabled, the device must be unpaired with the utility app and thus removed from the network.

## Security option flick-unpair and allow utility pairing disabled

If all network security options such as "Allow unpairing", "Allow flick-unpairing" and "Allow utility unpairing" are disabled and you have no access to the network, then the only option is to contact the network admin and to log into the network.

### NOTE



Without access to the network, there is no way of making changes to the device or removing it from a network.