



PHOS  
ENGINEERING LIGHT

## PANO MIDI SQUARE

HIGH EFFICIENCY



13W

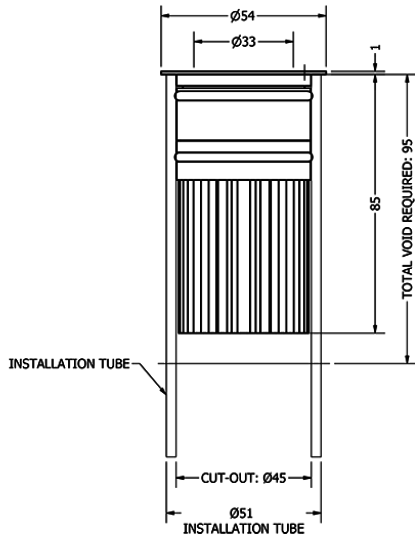

## TECHNICAL SPECIFICATIONS

<b>CCT</b>	<b>2700K</b>			
<b>Wattage</b>	<b>13W</b>			
<b>BeamAngle</b>	20°	25°	30°	50°
<b>Luminaire Lumens (lm)</b>	1100	949	981	973
<b>Circuit Watts (c/W)</b>	14.4	14.3	14.3	14.3
<b>LuminaireEfficacy (l/cW)</b>	76	66	69	68
<b>Luminance (Cd)</b>	6853	3659	3177	1262
<b>Light Source (Lm/W)</b>	110	110	110	110
<b>Engine (Lm/W)</b>	89	89	89	89
<b>Forward Volatage (Vf)</b>	18.2	18.2	18.2	18.2
<b>Current (mA)</b>	700	700	700	700
<b>CCT</b>	<b>3000K</b>			
<b>Wattage</b>	<b>13W</b>			
<b>BeamAngle</b>	20°	25°	30°	50°
<b>Luminaire Lumens (lm)</b>	1130	957	988	989
<b>Circuit Watts (c/W)</b>	14.5	14.5	14.5	14.5
<b>LuminaireEfficacy (l/cW)</b>	78	66	68	68
<b>Luminance (Cd)</b>	6887	3643	3325	1287
<b>Light Source (Lm/W)</b>	112	112	112	112
<b>Engine (Lm/W)</b>	93	93	93	93
<b>Forward Volatage (Vf)</b>	18.2	18.2	18.2	18.2
<b>Current (mA)</b>	700	700	700	700
<b>Binning</b>	2 step MacAdams			
<b>CRI</b>	90+			
<b>TM-30-15</b>	Rf87.76 - Rg103.99			
<b>Lumen Maintenance</b>	LM80			
<b>Lifetime</b>	50,000 hours			
<b>Dimming</b>	Mains Dim, DALI, CASAMBI, 0-10V, Non-dim			

## LIGHT CONES

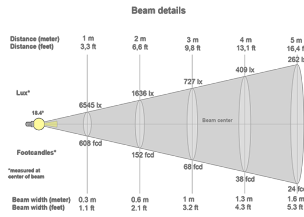

20°

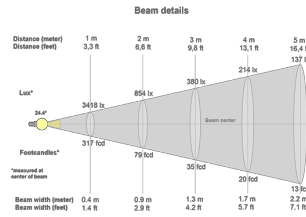

25°

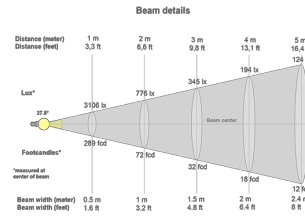

30°

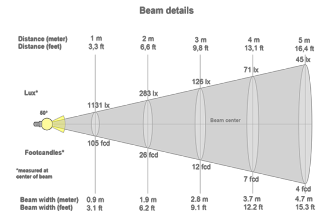

50°

## POLAR CURVES

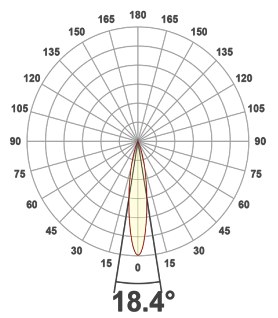

20°

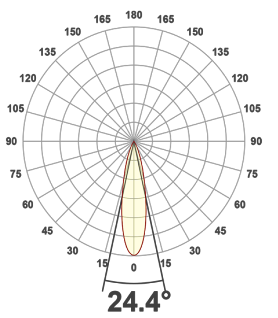

25°

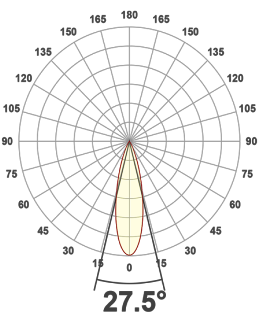

30°

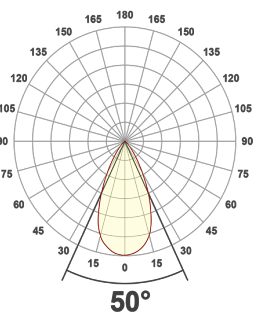

50°

## PART CODE BUILDER

Example Code: MD-P-SQ-WT-HE13-27-90-20-700

Family	Variant	Bezel Finish	Engine	Power	CCT	CRI	Beam Angle	Driver Current
MD	P-SQ	WT	HE	13W	27K	90	20°	700mA
		BT			30K		25°	
		*C					30°	
							50°	

# REGENERATION FOR GENERATIONS



View ReGen Doc



**TAKE**

Sourcing material locally



**MAKE**

Responsible manufacture



**WASTE**

Lifetime duty of care



## SOFT TM66 RESULTS

Category	Points Scored	MAX Possible Points	Assessment
Product Design	111.0	134.0	3.3
Manufacturing	35.0	46.5	3.0
Materials	11.0	24.0	1.8
Ecosystem	36.0	43.0	3.3
Overall Performance	193.0	247.5	2.9
2.5 to 4.0	Excellent circularity		

TM65 Available upon request

*Embodied carbon in building services*

WE ENCOURAGE ALL FIXTURES TO BE RETURNED TO US SO WE CAN REGEN OR RECYCLE.

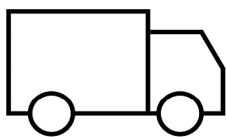

If a product has failed or has become EOL, we can arrange collection of the interchangeable light engines and associated drivers. Once received, we will review the engine to see if it can be **ReGenerated** or **recycled**.



If we can **ReGenerate** the light engine, we will only need to replace the faulty part of the fitting, which can then be restored to life, utilising all of our original optics and bezels.

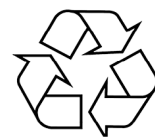

If the unit is beyond the point of repair, we will ensure the raw material is always fully recycled. We encourage all fixtures to be returned to us so we can **ReGen** or **recycle**.

**ACCESSORIES**



Midi Installation Tube

ACC-MD-TUBE

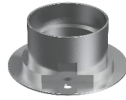

Midi Collar Tube

ACCS-MD-COLLARTUBE

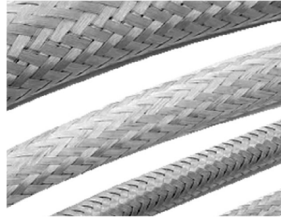

Exterior Cable Sleeve

ACCS-E-CABLESLEEVE-5MM

**INSERTS**



Elliptical Insert  
*NOT available for square versions*

EL



Asymmetric Insert  
*NOT available for square versions*

AS



Softening Insert

SL

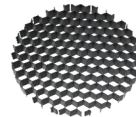

Honeycomb Insert

HC



Halfmoon Insert  
*NOT available for square versions*

HM



Colour Change Insert

- CCT: 18K
- CCT: 22K
- CCT: 24K
- CCT: 25K

## FINISHES

Every element of your light can be finished in any of the options below, or RAL colour:

### PLATED (Interior ONLY)

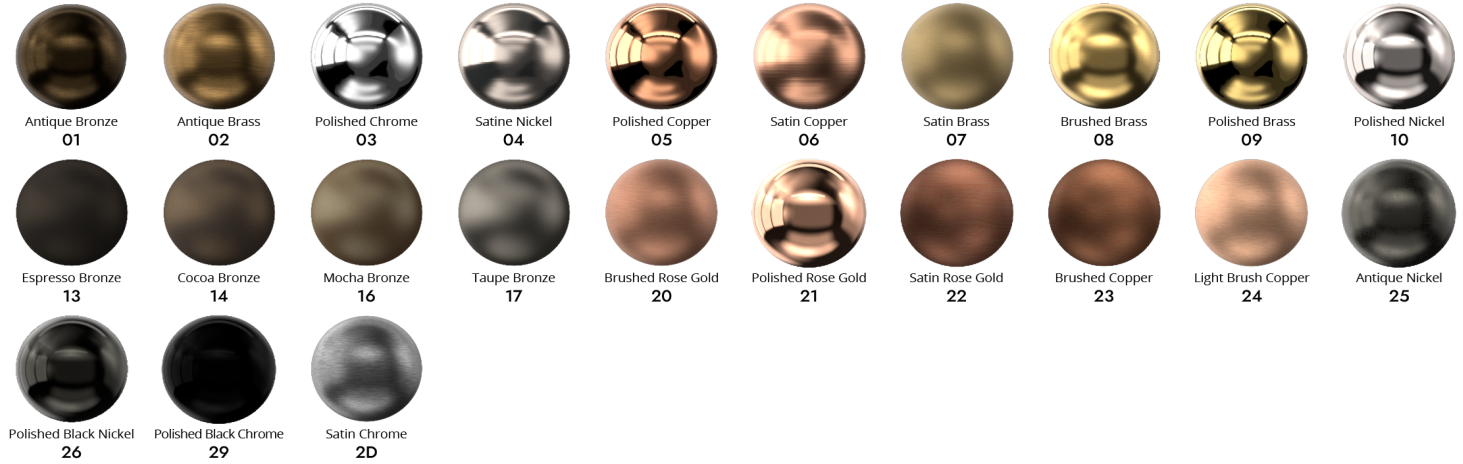

### ANODISED (Interior ONLY)

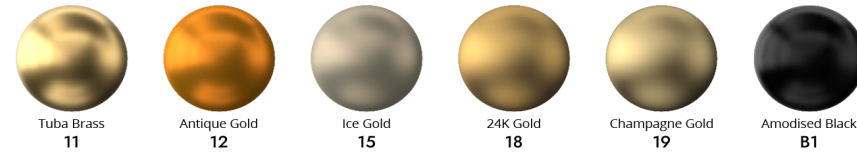

### SPECIALITY PLATED (Interior ONLY)



### POWDER COAT (Interior & Exterior)



### METAL POWDER COAT (Interior & Exterior)

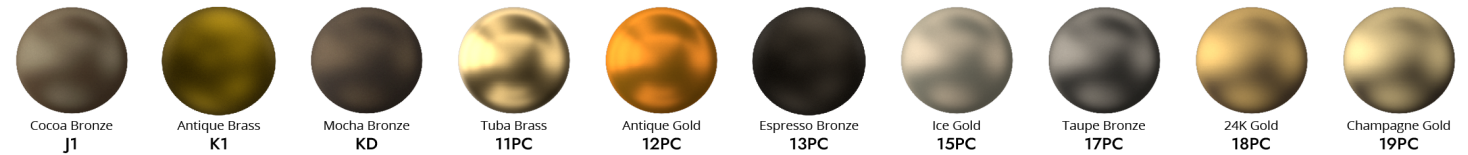

### MARINE GRADE (Interior, Exterior & Harsh Environment)



### SPECIALITY POWDER COAT (Interior & Exterior)

