

PHOS
ENGINEERING LIGHT

PANO MINI EYELID SQUARE SPRING

STANDARD

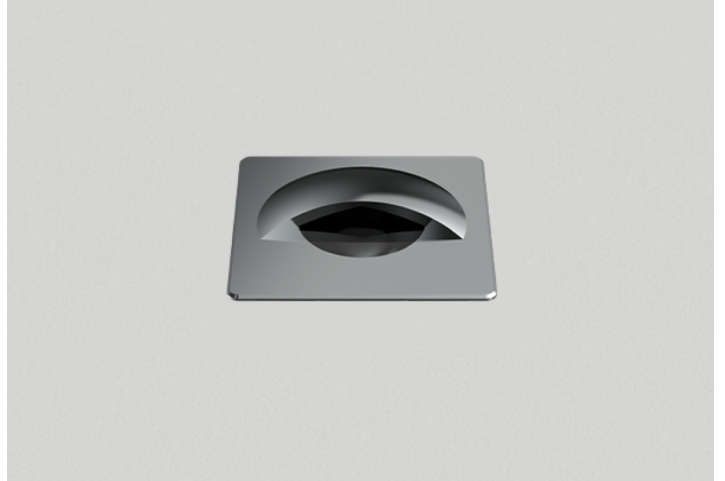

1 & 3W

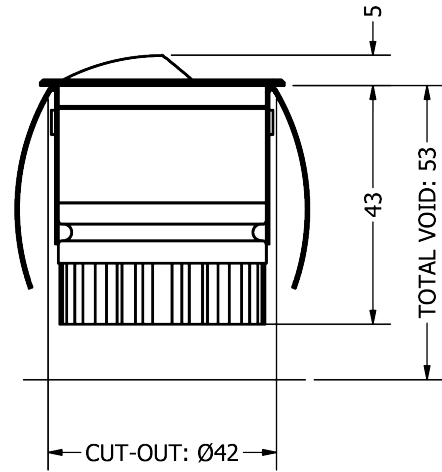
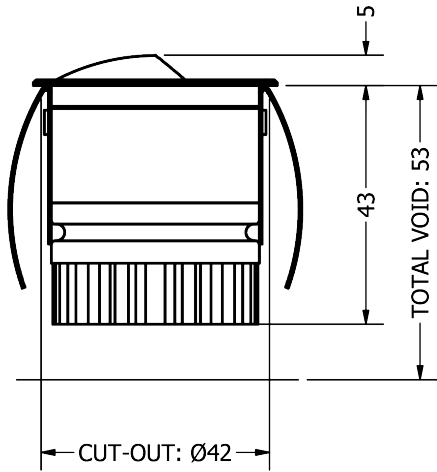

TECHNICAL SPECIFICATIONS

CCT	2700K	
Wattage	1W	3W
BeamAngle	20°	20°
Luminaire Lumens (lm)	56	130
Circuit Watts (c/W)	2.6	5.6
LuminaireEfficacy (l/cW)	21	23
Luminance (Cd)	230	557
Light Source (Lm/W)	146	117
Engine (Lm/W)	49	68
Forward Volatage (Vf)	2.78	2.97
Current (mA)	350	1050

CCT	3000K	
Wattage	1W	3W
BeamAngle	20°	20°
Luminaire Lumens (lm)	63	157
Circuit Watts (c/W)	2.6	5.5
LuminaireEfficacy (l/cW)	24	28
Luminance (Cd)	251	643
Light Source (Lm/W)	146	117
Engine (Lm/W)	55	73
Forward Volatage (Vf)	2.78	2.97
Current (mA)	350	1050

Binning	2 step MacAdams
CRI	90+
TM-30-15	Rf90.37 - Rg97.12
Lumen Maintenance	LM80
Lifetime	50,000 hours
Dimming	Mains Dim, DALI, CASAMBI, 0-10V, Non-dim

LIGHT CONES

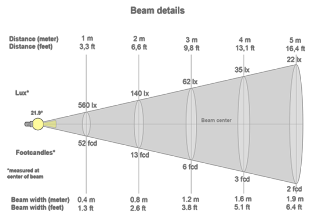

20°

POLAR CURVES

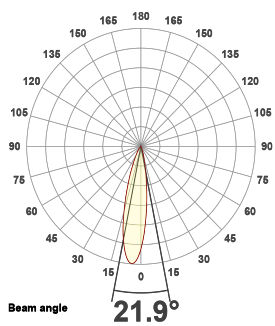

20°

PART CODE BUILDER

Example Code: MI-PE-SQ-S-WT-STD1-27-90-20-350

Family	Variant	Bezel Finish	Engine	Power	CCT	CRI	Beam Angle	Driver Current
MI	PE-SQ-S	WT	STD	1W	27K	90	20°	350mA
		BT		3W	30K			1050mA
		*C						

REGENERATION FOR GENERATIONS



View ReGen Doc



TAKE
Sourcing material locally



MAKE
Responsible manufacture



WASTE
Lifetime duty of care



IRYS TM66 RESULTS

Category	Points Scored	MAX Possible Points	Assessment
Product Design	108.0	134.0	3.2
Manufacturing	35.0	46.5	3.0
Materials	11.0	24.0	1.8
Ecosystem	36.0	43.0	3.3
Overall Performance	190.0	247.5	2.9
2.5 to 4.0	Excellent circularity		

TM65 Available upon request
Embodied carbon in building services

WE ENCOURAGE ALL FIXTURES TO BE RETURNED TO US SO WE CAN REGEN OR RECYCLE.

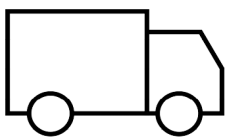

If a product has failed or has become EOL, we can arrange collection of the interchangeable light engines and associated drivers. Once received, we will review the engine to see if it can be **ReGenerated** or **recycled**.



If we can **ReGenerate** the light engine, we will only need to replace the faulty part of the fitting, which can then be restored to life, utilising all of our original optics and bezels.

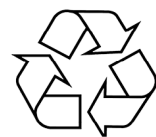

If the unit is beyond the point of repair, we will ensure the raw material is always fully recycled. We encourage all fixtures to be returned to us so we can **ReGen** or **recycle**.

ACCESSORIES



Mini Installation Tube

ACC-MI-TUBE

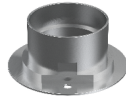

Mini Collar Tube

ACCS-MI-COLLARTUBE

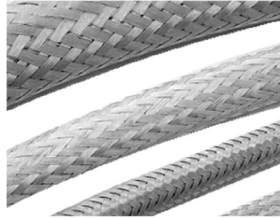

Exterior Cable Sleeve

ACCS-E-CABLESLEEVE-5MM

INSERTS



Elliptical Insert

NOT available for square or eyelid versions

EL



Asymmetric Insert

NOT available for square or eyelid versions

AS



Softening Insert

SL

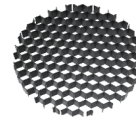

Honeycomb Insert

NOT available for puck

HC



Halfmoon Insert

NOT available for square or eyelid versions

HM



Colour Change Insert

CCT: 18K

CCT: 22K

CCT: 24K

CCT: 25K

FINISHES

Every element of your light can be finished in any of the options below, or RAL colour:

PLATED (Interior ONLY)

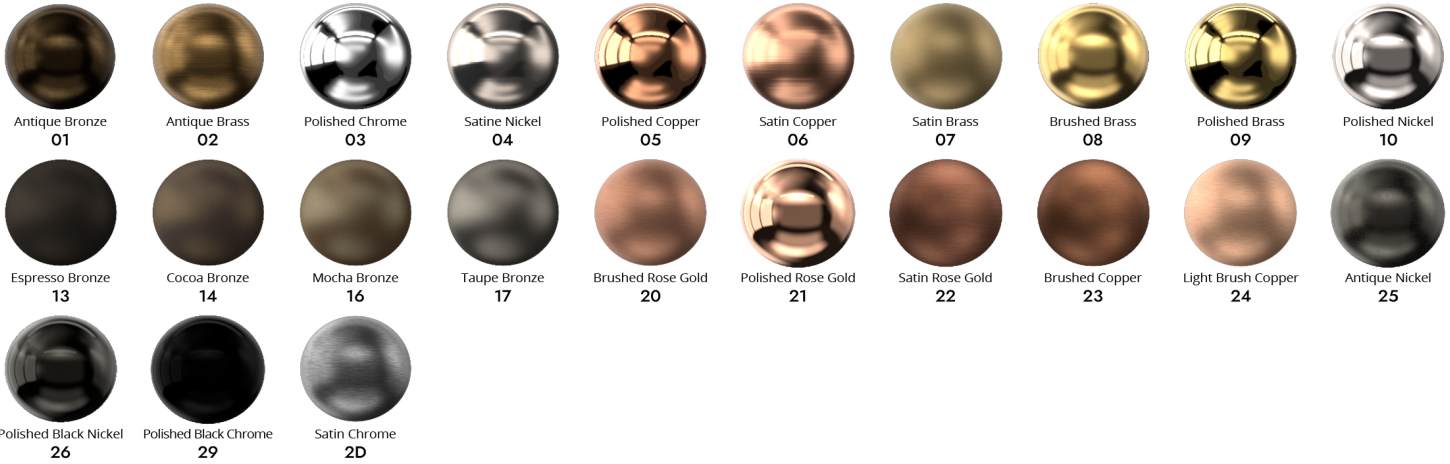

ANODISED (Interior ONLY)

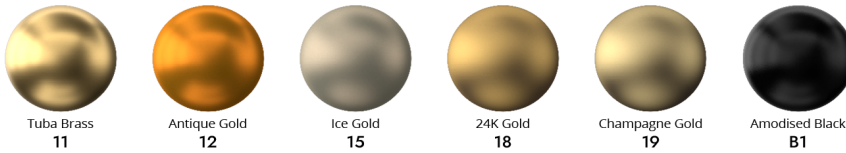

SPECIALITY PLATED (Interior ONLY)

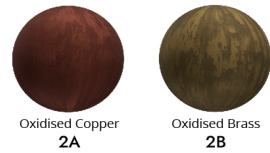

POWDER COAT (Interior & Exterior)



METAL POWDER COAT (Interior & Exterior)

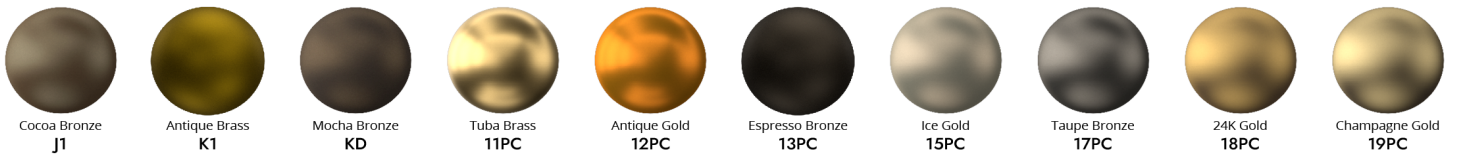

MARINE GRADE (Interior, Exterior & Harsh Environment)

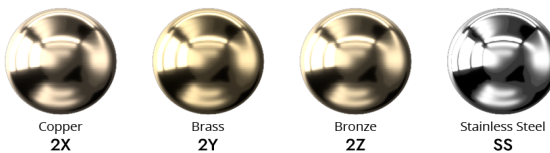

SPECIALITY POWDER COAT (Interior & Exterior)

