



PHOS
ENGINEERING LIGHT

PANO MIDI SQUARE

DIM TO WARM



6W

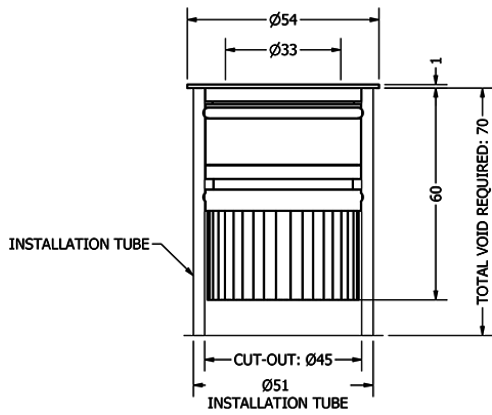

12W

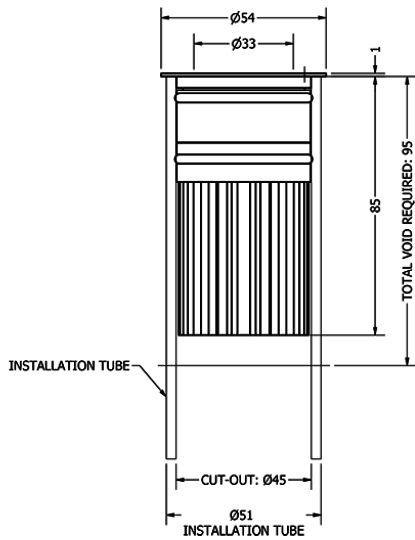

TECHNICAL SPECIFICATIONS

CCT	18/2700K				
Wattage	6W			12W	
BeamAngle	20°	30°	50°	30°	50°
Luminaire Lumens (lm)	403	375	353	681	624
Circuit Watts (c/W)	7.8	7.7	7.7	13.4	13.3
LuminaireEfficacy (l/cW)	52	49	46	51	47
Luminance (Cd)	1903	1185	488	1812	875
Light Source (Lm/W)	105	105	105	111	111
Engine (Lm/W)	73	73	73	85	85
Forward Volatage (Vf)	17	17	17	33.8	33.8
Current (mA)	350	350	350	350	350

CCT	18/3000K				
Wattage	6W			12W	
BeamAngle	20°	30°	50°	30°	50°
Luminaire Lumens (lm)	428	397	374	699	646
Circuit Watts (c/W)	7.8	7.8	7.8	13.4	13.4
LuminaireEfficacy (l/cW)	55	51	48	52	48
Luminance (Cd)	2011	1263	511	1887	910
Light Source (Lm/W)	110	110	110	117	117
Engine (Lm/W)	77	77	77	92	92
Forward Volatage (Vf)	17	17	17	33.8	33.8
Current (mA)	350	350	350	350	350

Binning	3 step MacAdams
CRI	90+
CRI	95+
TM-30-15	Rf87.28 - Rg105.35
Lumen Maintenance	LM80
Lifetime	50,000 hours
Dimming	Mains Dim, DALI, CASAMBI, 0-10V

LIGHT CONES

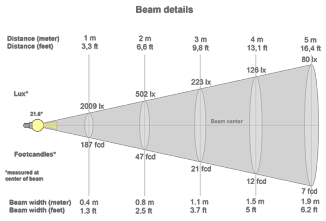

20°

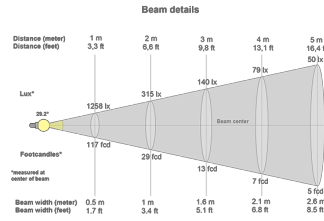

30°

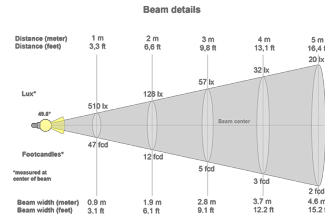

50°

POLAR CURVES

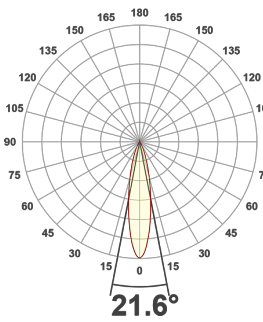

20°

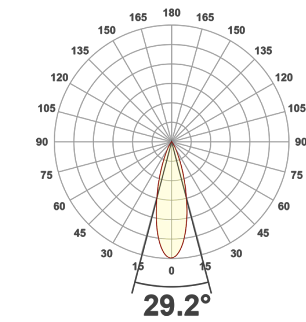

30°

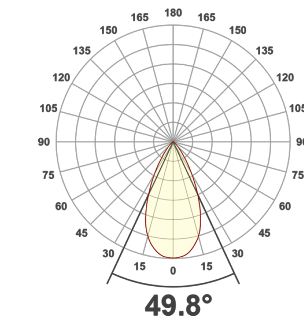

50°

PART CODE BUILDER

Example Code: MD-P-SQ-WT-DTW6-18-90-20-350

Family	Variant	Bezel Finish	Engine	Power	CCT	CRI	Beam Angle	Driver Current
MD	P-SQ	WT	DTW	6W	18/27K	90	20°	350mA
		BT		12W	18/30K	95	30°	
		*C					50°	

REGENERATION FOR GENERATIONS



View ReGen Doc



TAKE

Sourcing material locally



MAKE

Responsible manufacture



WASTE

Lifetime duty of care



SOFT TM66 RESULTS

Category	Points Scored	MAX Possible Points	Assessment
Product Design	111.0	134.0	3.3
Manufacturing	35.0	46.5	3.0
Materials	11.0	24.0	1.8
Ecosystem	36.0	43.0	3.3
Overall Performance	193.0	247.5	2.9
2.5 to 4.0	Excellent circularity		

TM65 Available upon request

Embodied carbon in building services

WE ENCOURAGE ALL FIXTURES TO BE RETURNED TO US SO WE CAN REGEN OR RECYCLE.

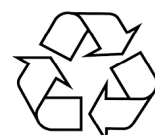
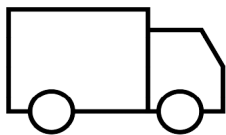

If a product has failed or has become EOL, we can arrange collection of the interchangeable light engines and associated drivers. Once received, we will review the engine to see if it can be **ReGenerated** or **recycled**.

If we can **ReGenerate** the light engine, we will only need to replace the faulty part of the fitting, which can then be restored to life, utilising all of our original optics and bezels.

If the unit is beyond the point of repair, we will ensure the raw material is always fully recycled. We encourage all fixtures to be returned to us so we can **ReGen** or **recycle**.

ACCESSORIES



Midi Installation Tube

ACC-MD-TUBE

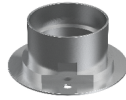

Midi Collar Tube

ACCS-MD-COLLARTUBE

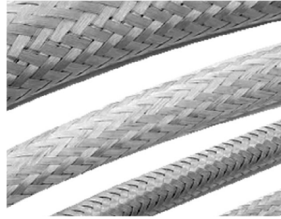

Exterior Cable Sleeve

ACCS-E-CABLESLEEVE-5MM

INSERTS



Elliptical Insert
NOT available for square versions

EL



Asymmetric Insert
NOT available for square versions

AS



Softening Insert

SL

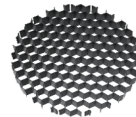

Honeycomb Insert

HC



Halfmoon Insert
NOT available for square versions

HM



Colour Change Insert

- CCT: 18K
- CCT: 22K
- CCT: 24K
- CCT: 25K

FINISHES

Every element of your light can be finished in any of the options below, or RAL colour:

PLATED (Interior ONLY)

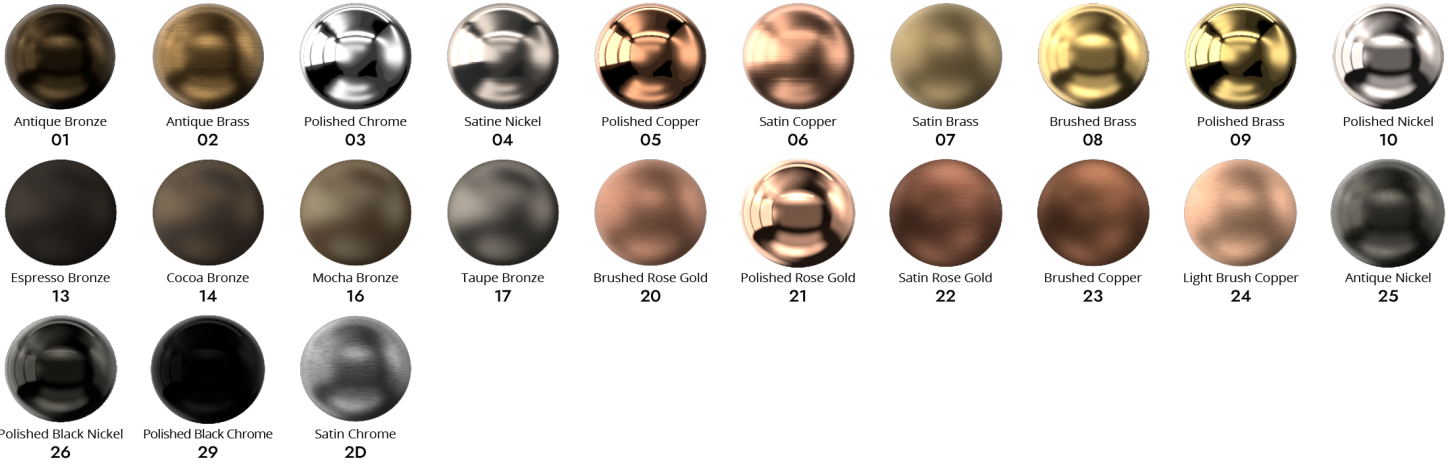

ANODISED (Interior ONLY)

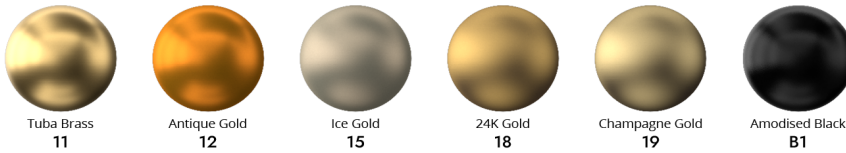

SPECIALITY PLATED (Interior ONLY)

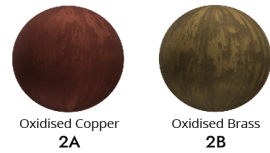

POWDER COAT (Interior & Exterior)



METAL POWDER COAT (Interior & Exterior)

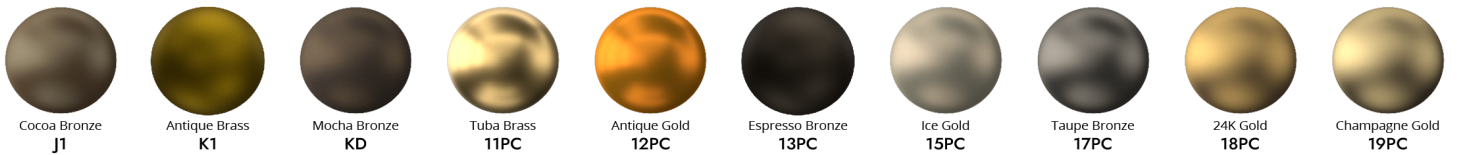

MARINE GRADE (Interior, Exterior & Harsh Environment)

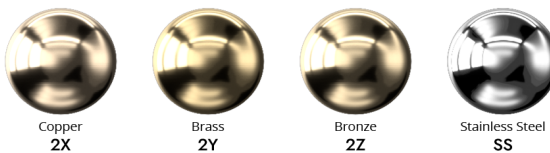

SPECIALITY POWDER COAT (Interior & Exterior)

