



PHOS
ENGINEERING LIGHT

EYECONIC SURFACE MOUNT FIXED

GENESIS



13W

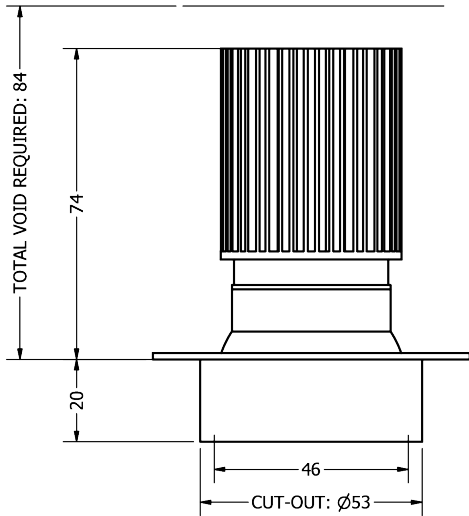

TECHNICAL SPECIFICATIONS

CCT	2700K			
Wattage	13W			
BeamAngle	20°	25°	30°	50°
Luminaire Lumens (lm)	897	799	801	812
Circuit Watts (c/W)	14.5	14.6	14.6	14.5
LuminaireEfficacy (l/cW)	62	55	55	56
Luminace (Cd)	5233	3003	2534	1051
Light Source (Lm/W)	91	91	91	91
Engine (Lm/W)	74	74	74	74
Forward Volatage (Vf)	18.2	18.2	18.2	18.2
Current (mA)	700	700	700	700

CCT	3000K			
Wattage	13W			
BeamAngle	20°	25°	30°	50°
Luminaire Lumens (lm)	933	826	833	847
Circuit Watts (c/W)	14.6	14.6	14.6	14.6
LuminaireEfficacy (l/cW)	64	56	57	58
Luminace (Cd)	5697	3170	2661	1086
Light Source (Lm/W)	97	97	97	97
Engine (Lm/W)	78	78	78	78
Forward Volatage (Vf)	18.2	18.2	18.2	18.2
Current (mA)	700	700	700	700

Binning	2 step MacAdams
CRI	98+
TM-30-15	Rf97.35 - Rg100.88
Lumen Maintenance	LM80
Lifetime	50,000 hours
Dimming	Mains Dim, DALI, CASAMBI, 0-10V, Non-dim

LIGHT CONES

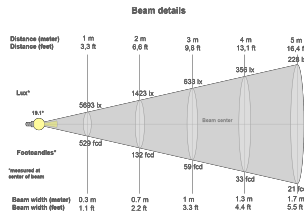

20°

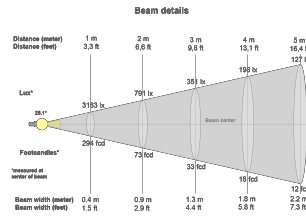

25°

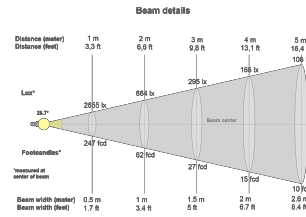

30°

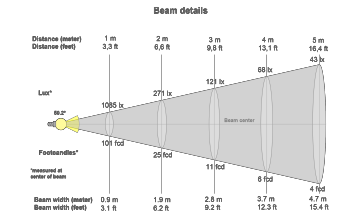

50°

POLAR CURVES

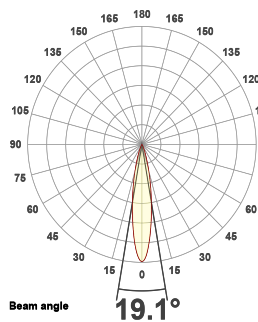

20°

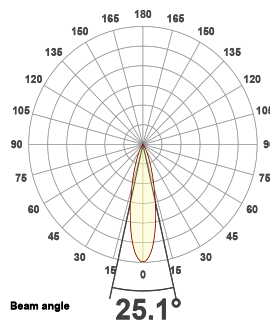

25°

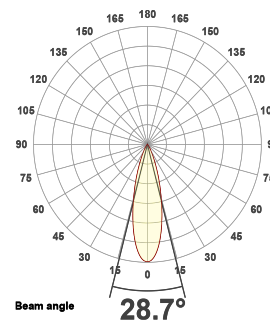

30°

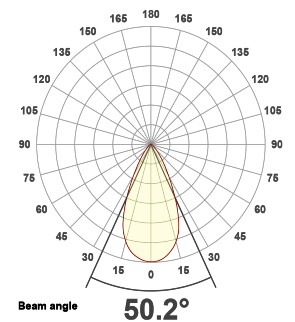

50°

PART CODE BUILDER

Example Code: EY-TF-WT/WT-GEN13-27-98-20-700

Family	Variant	Frame Finish	InnerBaffle Finish	Engine	Power	CCT	CRI	Beam Angle	Driver Current
EY	TF	WT	WT	GEN	13W	27K	98	20°	700mA
		BT	BT			30K		25°	
		*C	*C					30°	
								50°	

Frame Example : FR-SM-WT

Variant	Frame Finish
FR-SM	WT
	B2

REGENERATION FOR GENERATIONS



View ReGen Doc



TAKE
Sourcing material locally



MAKE
Responsible manufacture



WASTE
Lifetime duty of care



EYECONIC & ECLIPSE TM66 RESULTS

Category	Points Scored	MAX Possible Points	Assessment
Product Design	111.0	134.0	3.3
Manufacturing	35.0	46.5	3.0
Materials	11.0	24.0	1.8
Ecosystem	36.0	43.0	2.2
Overall Performance	193.0	247.5	2.9
2.5 to 4.0	Excellent circularity		

TM65 Available upon request

Embodied carbon in building services

WE ENCOURAGE ALL FIXTURES TO BE RETURNED TO US SO WE CAN REGEN OR RECYCLE.

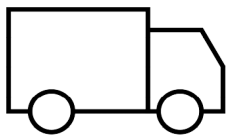

If a product has failed or has become EOL, we can arrange collection of the interchangeable light engines and associated drivers. Once received, we will review the engine to see if it can be **ReGenerated** or **recycled**.



If we can **ReGenerate** the light engine, we will only need to replace the faulty part of the fitting, which can then be restored to life, utilising all of our original optics and bezels.

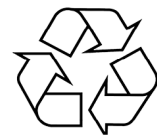

If the unit is beyond the point of repair, we will ensure the raw material is always fully recycled. We encourage all fixtures to be returned to us so we can **ReGen** or **recycle**.

ACCESSORIES



Commissioning Tool
ACCS-TOOL-M-BAFFLE



Wall Wash Removal Tool
Wall Wash ONLY
ACC-WW-TOOL



Snoot
Adjustable ONLY
ACCS-SHOOT



Force Springs
Mini Trim / Round & Square ONLY
CZ7SPRING-CTC



Trimless Bung
Trimless ONLY
ACCS-EY-BUNG

INSERTS



Softening Insert Recessed
ACCS-RECESSED-SOFT



Softening Insert Flush
ACCS-FLUSH-SOFT



Asymmetric Insert Recessed
ACCS-RECESSED-ASYM



Asymmetric Insert Flush
ACCS-FLUSH-ASYM



Elliptical Insert Recessed
ACCS-RECESSED-10X60ELLIPTICAL



Elliptical Insert Flush
ACCS-FLUSH-10X60ELLIPTICAL



Honeycomb Recessed
ACCS-RECESSED-HCOMB



Honeycomb Flush
ACCS-FLUSH-HCOMB



Colour Change Insert Recessed
ACCS-RECESSED-FILTER18K
ACCS-RECESSED-FILTER22K
ACCS-RECESSED-FILTER24K
ACCS-RECESSED-FILTER25K



Colour Change Insert Flush
ACCS-FLUSH-FILTER18K
ACCS-FLUSH-FILTER22K
ACCS-FLUSH-FILTER24K
ACCS-FLUSH-FILTER25K

FINISHES

Every element of your light can be finished in any of the options below, or RAL colour:

PLATED (Interior ONLY)

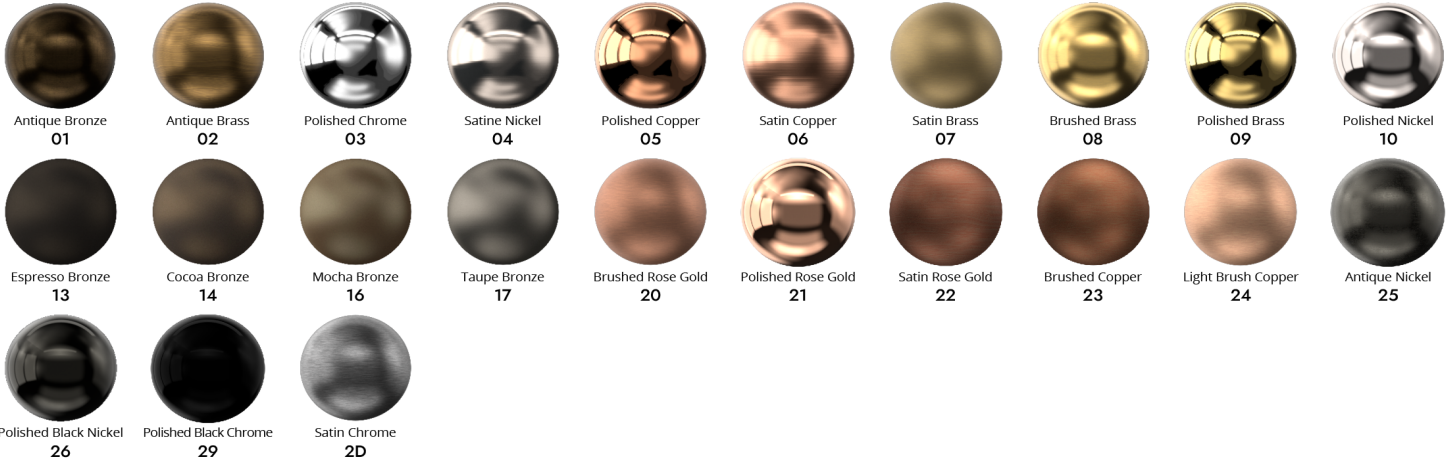

ANODISED (Interior ONLY)

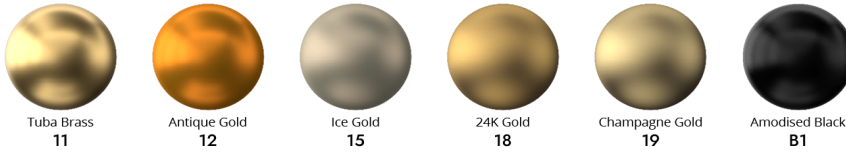

SPECIALITY PLATED (Interior ONLY)

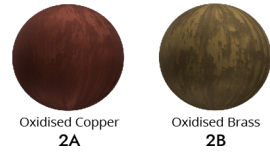

POWDER COAT (Interior & Exterior)



METAL POWDER COAT (Interior & Exterior)

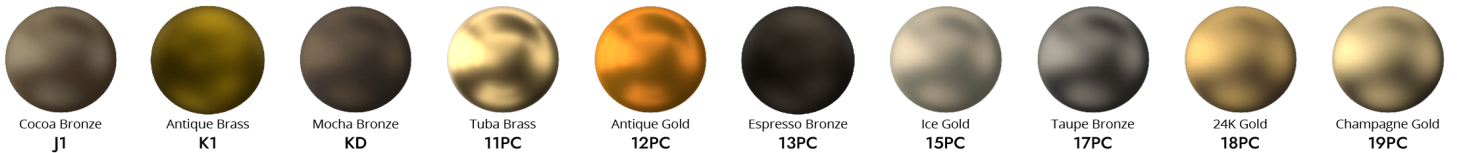

MARINE GRADE (Interior, Exterior & Harsh Environment)

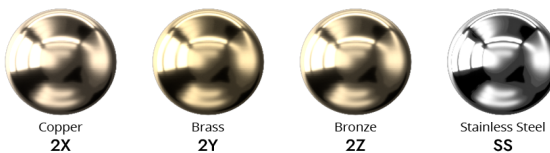

SPECIALITY POWDER COAT (Interior & Exterior)

