



PHOS  
ENGINEERING LIGHT

EYECONIC NEMO MINI TRIM FIXED

GENESIS TUNEABLE



9W

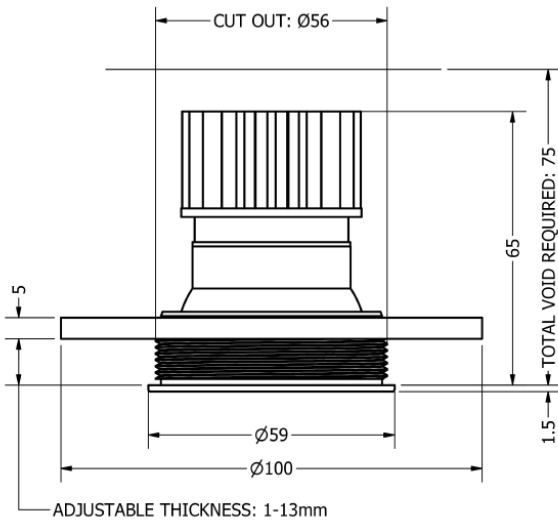

## TECHNICAL SPECIFICATIONS

CCT	27/5000K			
Wattage	9W			
BeamAngle	25°	30°	35°	50°
Luminaire Lumens (lm)	710	654	683	679
Circuit Watts (c/W)	10.9	10.8	10.9	10.9
LuminaireEfficacy (l/cW)	65	61	63	62
Luminance (Cd)	2211	1575	1632	857
Light Source (Lm/W)	105	105	105	105
Engine (Lm/W)	86	86	86	86
Forward Volatage (Vf)	36	36	36	36
Current (mA)	250	250	250	250
Binning	2 step MacAdams			
CRI	98+			
TM-30-15	Rf95.56 - Rg99.55			
Lumen Maintenance	LM80			
Lifetime	50,000 hours			
Dimming	DALI DT6, DALI DT8, CASAMBI			

## LIGHT CONES

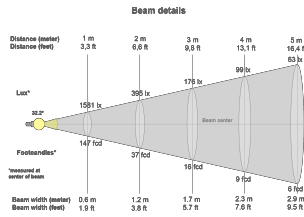

30°

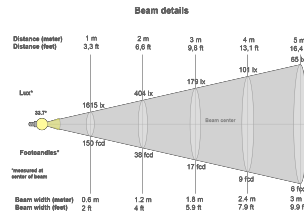

35°

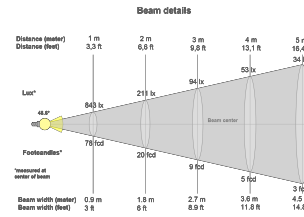

50°

## POLAR CURVES

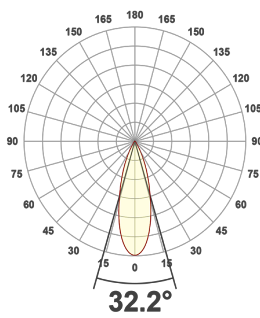

30°

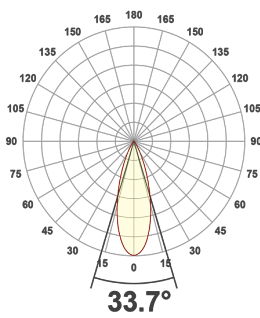

35°

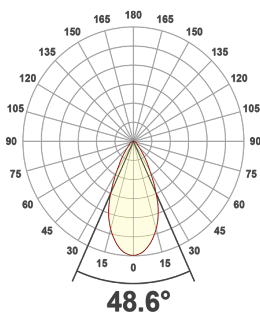

50°

## PART CODE BUILDER

Example Code: EY-TF-WT/WT-GENTN9-27-98-25-250

Family	Variant	Frame Finish	InnerBaffle Finish	Engine	Power	CCT	CRI	Beam Angle	Driver Current
EY	TF	WT	WT	GENTN	9W	27/50K	98	25°	250mA
		BT	BT					30°	
		*C	*C					35°	
								50°	

Frame Example : FR-NM-MT-WT

Variant	Frame Finish
FR-NM-MT	WT
	B2

# REGENERATION FOR GENERATIONS



View ReGen Doc



**TAKE**

Sourcing material locally



**MAKE**

Responsible manufacture



**WASTE**

Lifetime duty of care



## EYECONIC & ECLIPSE TM66 RESULTS

Category	Points Scored	MAX Possible Points	Assessment
Product Design	111.0	134.0	3.3
Manufacturing	35.0	46.5	3.0
Materials	11.0	24.0	1.8
Ecosystem	36.0	43.0	2.2
Overall Performance	193.0	247.5	2.9
2.5 to 4.0	Excellent circularity		

TM65 Available upon request

*Embodied carbon in building services*

WE ENCOURAGE ALL FIXTURES TO BE RETURNED TO US SO WE CAN REGEN OR RECYCLE.

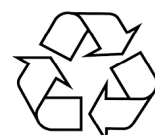
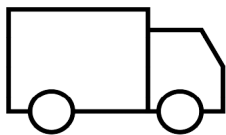

If a product has failed or has become EOL, we can arrange collection of the interchangeable light engines and associated drivers. Once received, we will review the engine to see if it can be **ReGenerated** or **recycled**.

If we can **ReGenerate** the light engine, we will only need to replace the faulty part of the fitting, which can then be restored to life, utilising all of our original optics and bezels.

If the unit is beyond the point of repair, we will ensure the raw material is always fully recycled. We encourage all fixtures to be returned to us so we can **ReGen** or **recycle**.

**ACCESSORIES**



Commissioning Tool  
ACCS-TOOL-M-BAFFLE



Wall Wash Removal Tool  
*Wall Wash ONLY*  
ACC-WW-TOOL



Snoot  
*Adjustable ONLY*  
ACCS-SHOOT



Force Springs  
*Mini Trim / Round & Square ONLY*  
CZ7SPRING-CTC



Trimless Bung  
*Trimless ONLY*  
ACCS-EY-BUNG

**INSERTS**



Softening Insert Recessed  
ACCS-RECESSED-SOFT



Softening Insert Flush  
ACCS-FLUSH-SOFT



Asymmetric Insert Recessed  
ACCS-RECESSED-ASYM



Asymmetric Insert Flush  
ACCS-FLUSH-ASYM



Elliptical Insert Recessed  
ACCS-RECESSED-10X60ELLIPTICAL



Elliptical Insert Flush  
ACCS-FLUSH-10X60ELLIPTICAL



Honeycomb Recessed  
ACCS-RECESSED-HCOMB



Honeycomb Flush  
ACCS-FLUSH-HCOMB



Colour Change Insert Recessed  
ACCS-RECESSED-FILTER18K  
ACCS-RECESSED-FILTER22K  
ACCS-RECESSED-FILTER24K  
ACCS-RECESSED-FILTER25K



Colour Change Insert Flush  
ACCS-FLUSH-FILTER18K  
ACCS-FLUSH-FILTER22K  
ACCS-FLUSH-FILTER24K  
ACCS-FLUSH-FILTER25K



## FINISHES

Every element of your light can be finished in any of the options below, or RAL colour:

### PLATED (Interior ONLY)

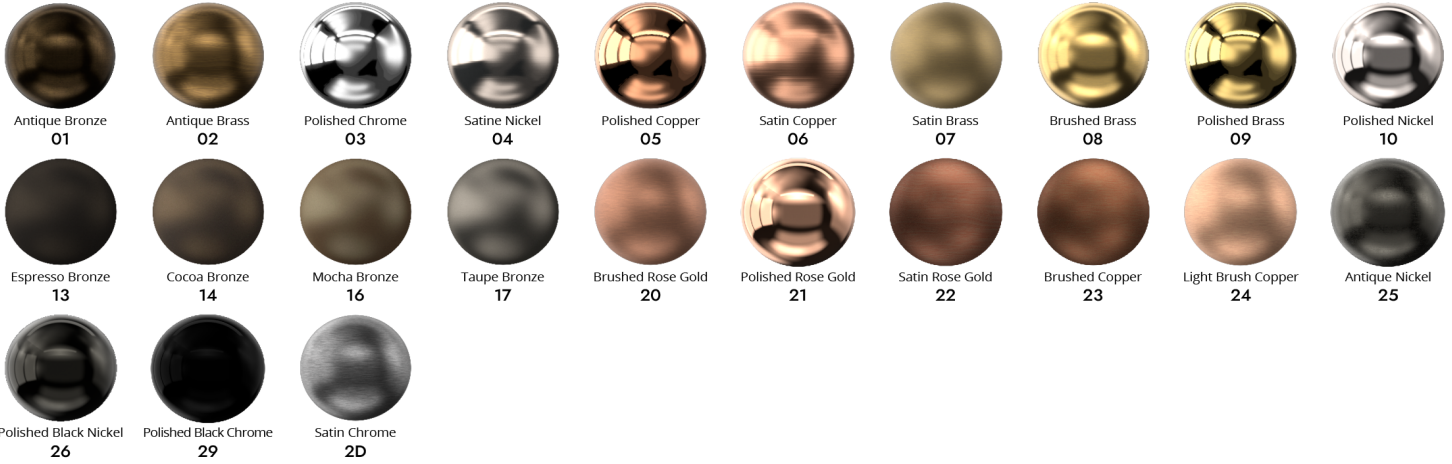

### ANODISED (Interior ONLY)

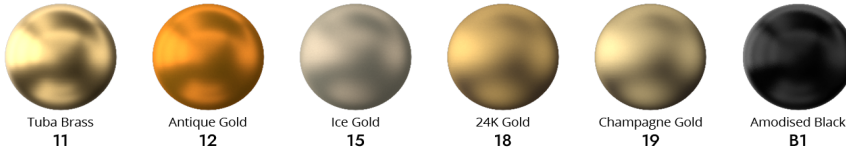

### SPECIALITY PLATED (Interior ONLY)

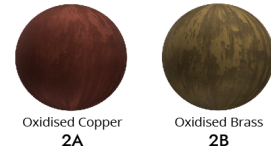

### POWDER COAT (Interior & Exterior)



### METAL POWDER COAT (Interior & Exterior)

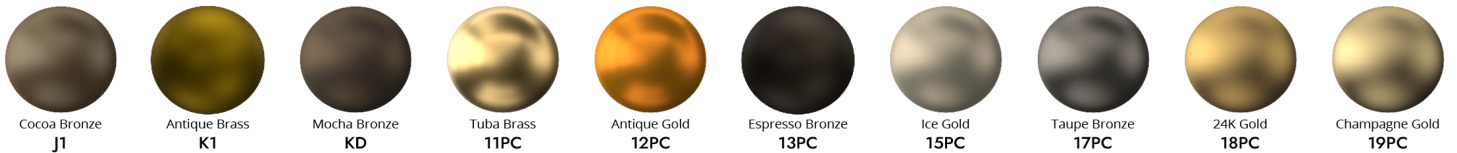

### MARINE GRADE (Interior, Exterior & Harsh Environment)

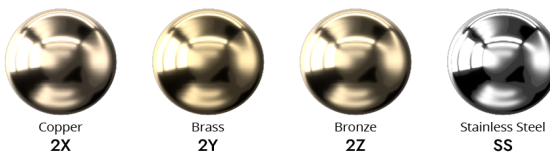

### SPECIALITY POWDER COAT (Interior & Exterior)

