

Certified

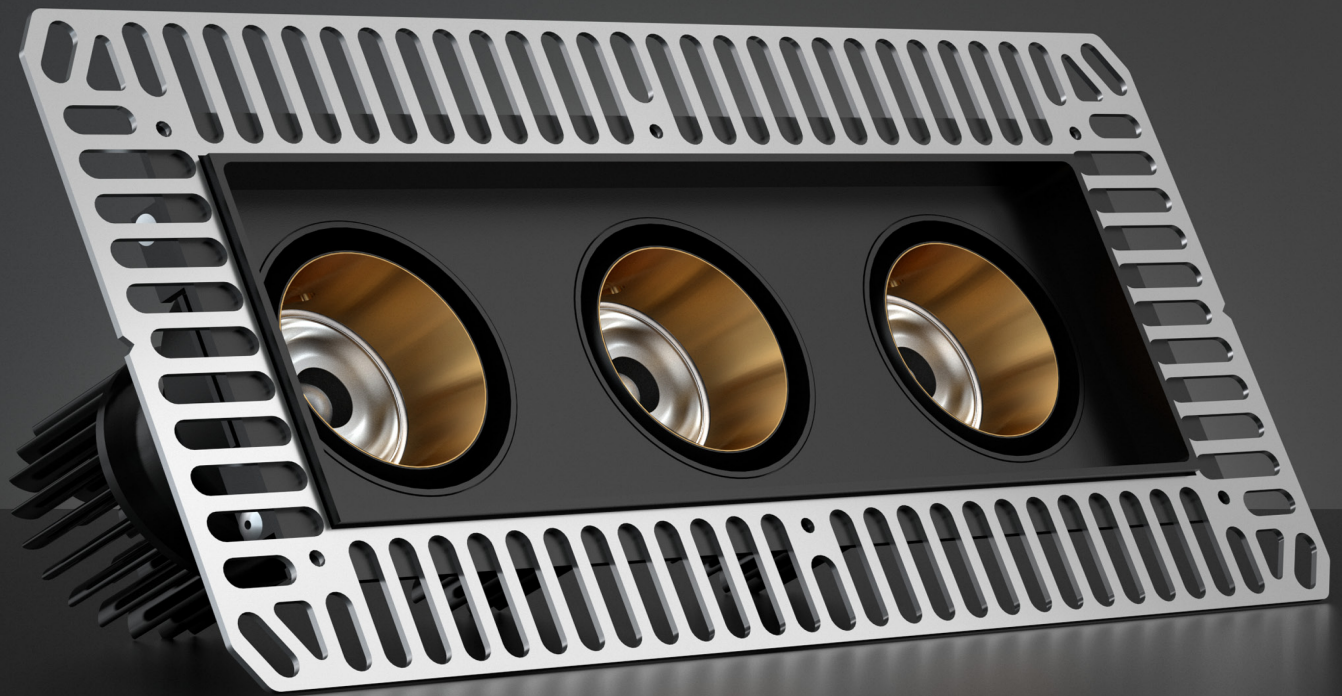

Corporation



PHOS
ENGINEERING LIGHT

EYECONIC TRIPLE RECESSED
TRIMLESS ADJUSTABLE
STANDARD

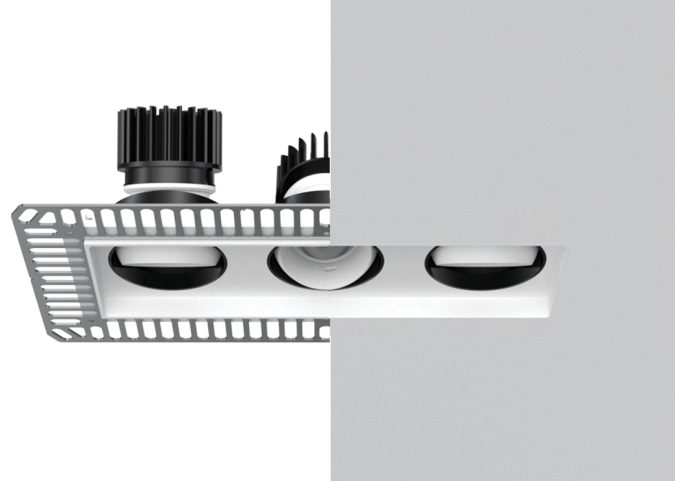
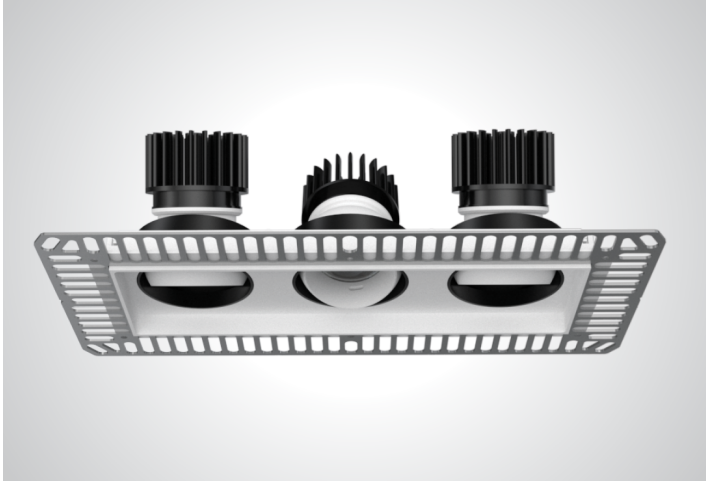

4 & 9W

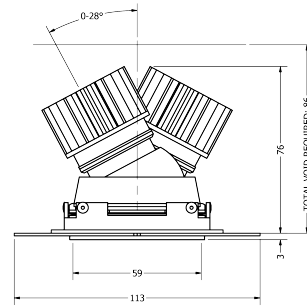
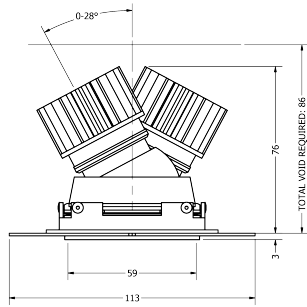
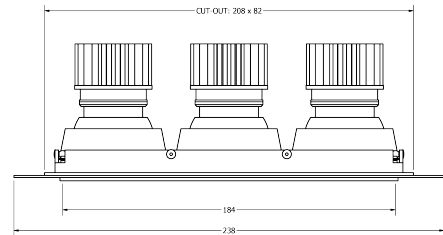
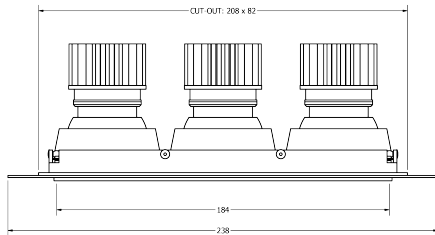

14W

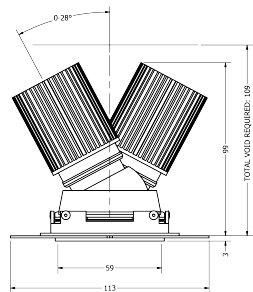
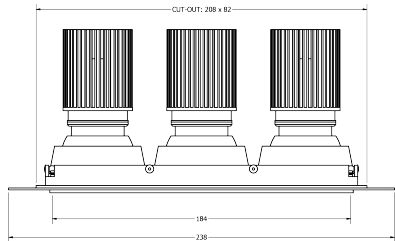

TECHNICAL SPECIFICATIONS

CCT	2700K												
Wattage	4W (X3)				9W (X3)				14W (X3)				
BeamAngle	10°	20°	30°	50°	10°	20°	30°	50°	10°	20°	30°	50°	
Luminaire Lumens (lm)	334	303	296	310	481	489	485	504	725	650	630	669	(X3)
Circuit Watts (c/W)	5.9	6	5.9	5.9	10.5	10.5	10.5	10.5	15.5	15.5	15.5	15.5	(X3)
Luminaire Efficacy (l/cW)	56	51	50	52	46	47	46	48	47	42	41	43	(X3)
Luminance (Cd)	6294	1521	888	381	8814	2507	1476	632	14516	3321	1969	832	(X3)
Light Source (Lm/W)	95	95	95	95	80	80	80	80	69	69	69	69	(X3)
Engine (Lm/W)	64	64	64	64	59	59	59	59	51	51	51	51	(X3)
Forward Volatage (Vf)	11.78	11.78	11.78	11.78	12.36	12.36	12.36	12.36	12.65	12.65	12.65	12.65	(X3)
Current (mA)	350	350	350	350	700	700	700	700	1050	1050	1050	1050	(X3)

CCT	3000K												
Wattage	4W (X3)				9W (X3)				14W (X3)				
BeamAngle	10°	20°	30°	50°	10°	20°	30°	50°	10°	20°	30°	50°	
Luminaire Lumens (lm)	378	342	336	355	635	580	564	597	893	772	772	801	(X3)
Circuit Watts (c/W)	5.9	5.9	5.9	5.9	10.6	10.5	10.5	10.5	15.8	15.7	15.7	15.6	(X3)
Luminaire Efficacy (l/cW)	64	58	57	61	60	55	54	57	57	49	49	51	(X3)
Luminance (Cd)	5827	1674	1018	442	9895	2855	1745	753	14115	4027	2529	1031	(X3)
Light Source (Lm/W)	95	95	95	95	80	80	80	80	69	69	69	69	(X3)
Engine (Lm/W)	76	76	76	76	71	71	71	71	62	62	62	62	(X3)
Forward Volatage (Vf)	11.78	11.78	11.78	11.78	12.36	12.36	12.36	12.36	12.65	12.65	12.65	12.65	(X3)
Current (mA)	350	350	350	350	700	700	700	700	1050	1050	1050	1050	(X3)

Binning	2 step MacAdams
CRI	90+
TM-30-15	Rf87.43 - Rg99.96
Lumen Maintenance	LM80
Lifetime	50,000 hours
Dimming	Mains Dim, DALI, CASAMBI, 0-10V, Non-dim

LIGHT CONES

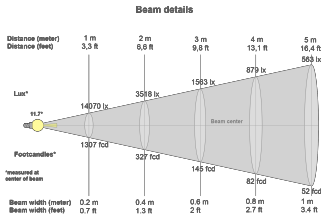

10°

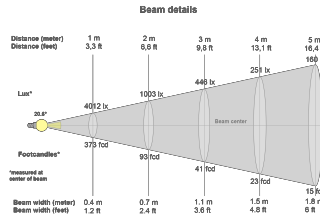

20°

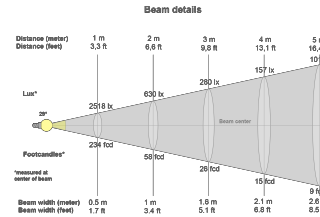

30°

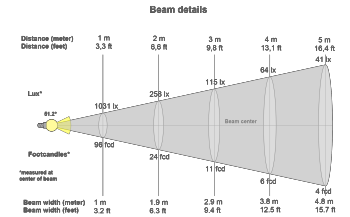

50°

POLAR CURVES

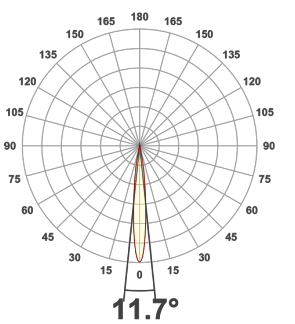

10°

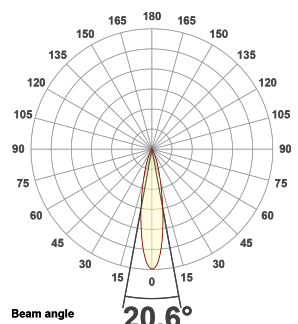

20°

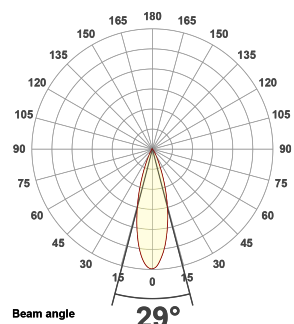

30°

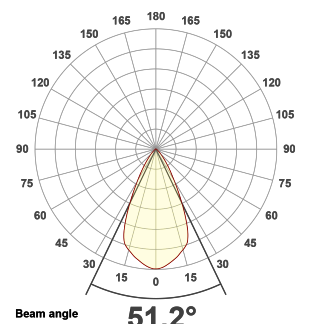

50°

PART CODE BUILDER

Example Code: EY-TA-WT/WT/BT-STD4-27-90-10-350

Family	Variant	Frame Finish	OuterBaffle Finish	InnerBaffle Finish	Engine	Power	CCT	CRI	Beam Angle	Driver Current
EY	TA	WT	WT	BT	STD	4W	27K	90	10°	350mA
		BT	BT	*C		9W	30K		20°	700mA
		*C	*C			14W			30°	1050mA
									50°	

Frame Example : TFR-RSQ3-WT

Variant	Frame Finish
TFR-RSQ3	WT
	B2

REGENERATION FOR GENERATIONS



View ReGen Doc



TAKE

Sourcing material locally



MAKE

Responsible manufacture



WASTE

Lifetime duty of care



EYECONIC & ECLIPSE TM66 RESULTS

Category	Points Scored	MAX Possible Points	Assessment
Product Design	111.0	134.0	3.3
Manufacturing	35.0	46.5	3.0
Materials	11.0	24.0	1.8
Ecosystem	36.0	43.0	2.2
Overall Performance	193.0	247.5	2.9
2.5 to 4.0	Excellent circularity		

TM65 Available upon request

Embodied carbon in building services

WE ENCOURAGE ALL FIXTURES TO BE RETURNED TO US SO WE CAN REGEN OR RECYCLE.

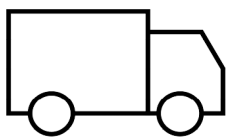

If a product has failed or has become EOL, we can arrange collection of the interchangeable light engines and associated drivers. Once received, we will review the engine to see if it can be **ReGenerated** or **recycled**.



If we can **ReGenerate** the light engine, we will only need to replace the faulty part of the fitting, which can then be restored to life, utilising all of our original optics and bezels.

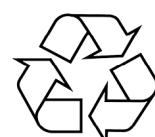

If the unit is beyond the point of repair, we will ensure the raw material is always fully recycled. We encourage all fixtures to be returned to us so we can **ReGen** or **recycle**.

ACCESSORIES



Commissioning Tool
ACCS-TOOL-M-BAFFLE



Wall Wash Removal Tool
Wall Wash ONLY
ACC-WW-TOOL



Snoot
Adjustable ONLY
ACCS-SHOOT



Force Springs
Mini Trim / Round & Square ONLY
CZ7SPRING-CTC



Trimless Bung
Trimless ONLY
ACCS-EY-BUNG

INSERTS



Softening Insert Recessed
ACCS-RECESSED-SOFT



Softening Insert Flush
ACCS-FLUSH-SOFT



Asymmetric Insert Recessed
ACCS-RECESSED-ASYM



Asymmetric Insert Flush
ACCS-FLUSH-ASYM



Elliptical Insert Recessed
ACCS-RECESSED-10X60ELLIPTICAL



Elliptical Insert Flush
ACCS-FLUSH-10X60ELLIPTICAL



Honeycomb Recessed
ACCS-RECESSED-HCOMB



Honeycomb Flush
ACCS-FLUSH-HCOMB



Colour Change Insert Recessed
ACCS-RECESSED-FILTER18K
ACCS-RECESSED-FILTER22K
ACCS-RECESSED-FILTER24K
ACCS-RECESSED-FILTER25K



Colour Change Insert Flush
ACCS-FLUSH-FILTER18K
ACCS-FLUSH-FILTER22K
ACCS-FLUSH-FILTER24K
ACCS-FLUSH-FILTER25K

FINISHES

Every element of your light can be finished in any of the options below, or RAL colour:

PLATED (Interior ONLY)

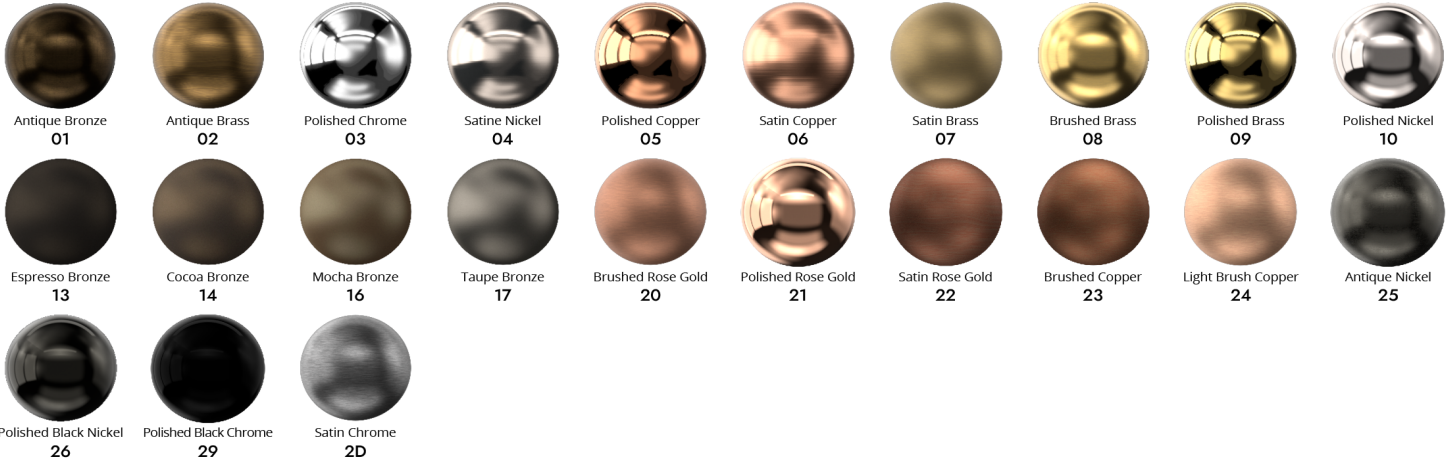

ANODISED (Interior ONLY)

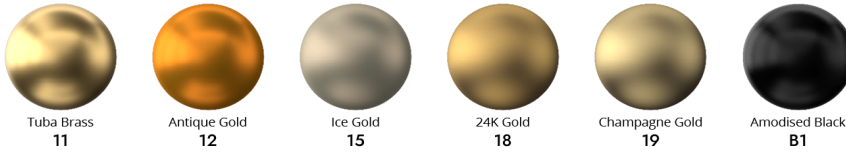

SPECIALITY PLATED (Interior ONLY)

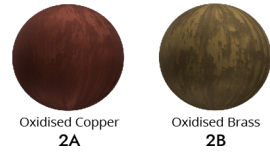

POWDER COAT (Interior & Exterior)



METAL POWDER COAT (Interior & Exterior)

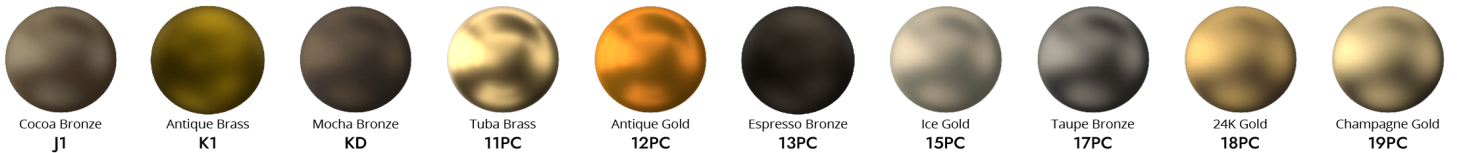

MARINE GRADE (Interior, Exterior & Harsh Environment)

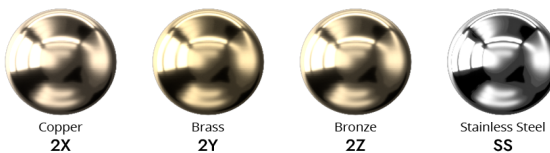

SPECIALITY POWDER COAT (Interior & Exterior)

