

PHOS
ENGINEERING LIGHT

MAXI ECLIPSE TRIMLESS ADJUSTABLE

PART L TECHNOLOGY

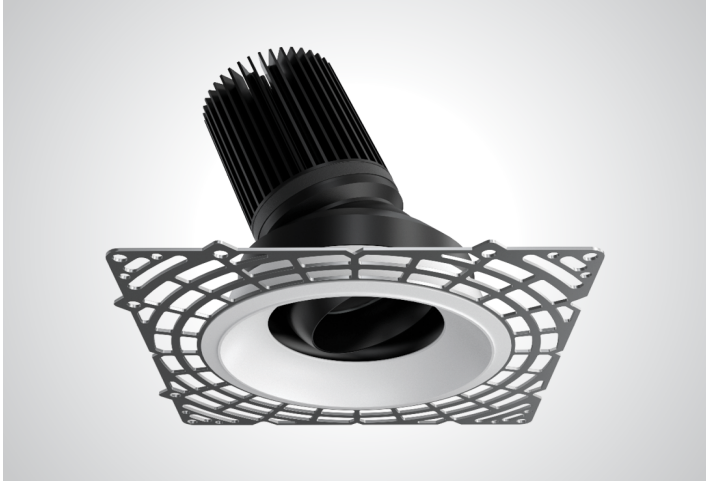

11W

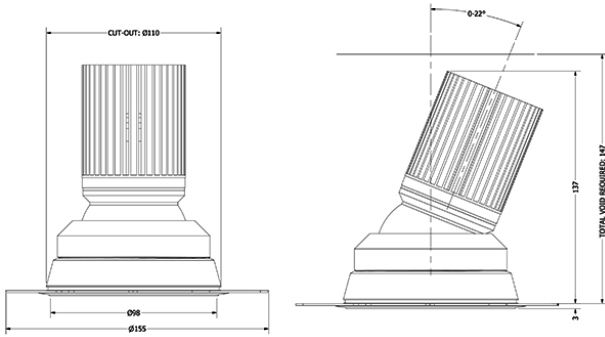

TECHNICAL SPECIFICATIONS

CCT	2700K			
Wattage	11W			
BeamAngle	20°	25°	30°	45°
Luminaire Lumens (lm)	1518	1550	1360	1471
Circuit Watts (c/W)	13.7	13.7	13.7	13.7
LuminaireEfficacy (l/cW)	111	114	99	108
Luminance (Cd)	9514	5617	3134	2118
Light Source (Lm/W)	180	180	180	180
Engine (Lm/W)	140	140	140	140
Forward Volatage (Vf)	31.6	31.6	31.6	31.6
Current (mA)	350	350	350	350
CCT	3000K			
Wattage	11W			
BeamAngle	20°	25°	30°	45°
Luminaire Lumens (lm)	1545	1496	1360	1472
Circuit Watts (c/W)	12.4	12.5	12.5	12.4
LuminaireEfficacy (l/cW)	125	120	109	119
Luminance (Cd)	10047	6038	3172	2235
Light Source (Lm/W)	178	178	178	178
Engine (Lm/W)	126	126	126	126
Forward Volatage (Vf)	31.6	31.6	31.6	31.6
Current (mA)	350	350	350	350
Binning	2 step MacAdams			
CRI	80+			
TM-30-15	Rf91.7 - Rg99.2			
Lumen Maintenance	LM80			
Lifetime	50,000 hours			
Dimming				

LIGHT CONES

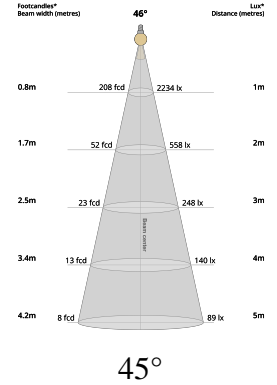
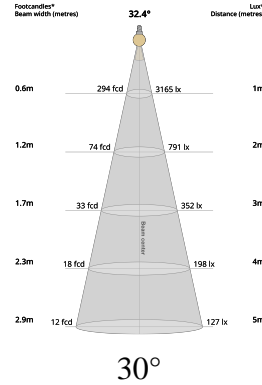
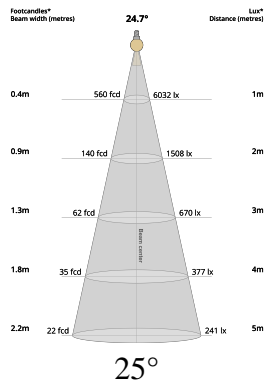
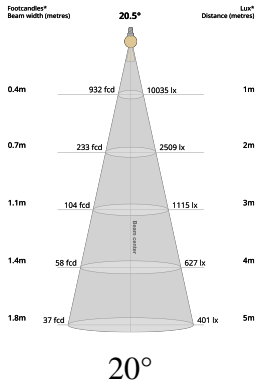

POLAR CURVES

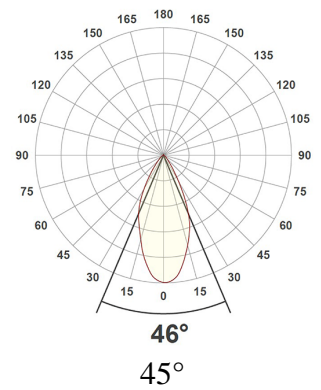
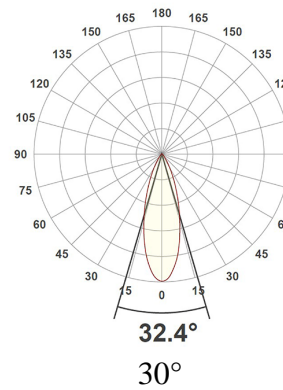
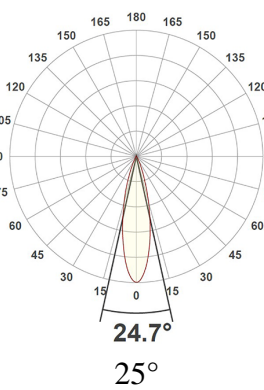
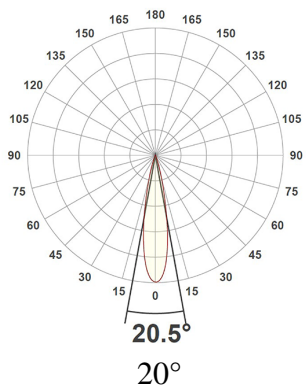

PART CODE BUILDER

Example Code: MX-EE-TA-WT/WT/BT/WT-PLT11-27-80-20-350

Family	Variant	Frame Finish	Socket Finish	OuterBaffle Finish	InnerBaffle Finish	Engine	Power	CCT	CRI	Beam Angle	Driver Current
MX	EE-TA	WT	WT	BT	WT	PLT	11W	27K	80	20°	350mA
		BT	BT	*C	BT			30K		25°	
		*C	*C		*C					30°	
										45°	

* Choose black on socket for minimal glare
Frame Example : MX-EE-TFR-WT

Variant	Frame Finish
MX-EE-TFR	WT
	B2

REGENERATION FOR GENERATIONS



View ReGen Doc



TAKE

Sourcing material locally



MAKE

Responsible manufacture



WASTE

Lifetime duty of care



EYECONIC & ECLIPSE TM66 RESULTS

Category	Points Scored	MAX Possible Points	Assessment
Product Design	111.0	134.0	3.3
Manufacturing	35.0	46.5	3.0
Materials	11.0	24.0	1.8
Ecosystem	36.0	43.0	2.2
Overall Performance	193.0	247.5	2.9
2.5 to 4.0	Excellent circularity		

TM65 Available upon request

Embodied carbon in building services

WE ENCOURAGE ALL FIXTURES TO BE RETURNED TO US SO WE CAN REGEN OR RECYCLE.

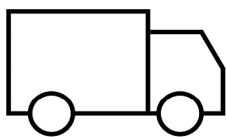

If a product has failed or has become EOL, we can arrange collection of the interchangeable light engines and associated drivers. Once received, we will review the engine to see if it can be **ReGenerated** or **recycled**.



If we can **ReGenerate** the light engine, we will only need to replace the faulty part of the fitting, which can then be restored to life, utilising all of our original optics and bezels.

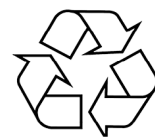

If the unit is beyond the point of repair, we will ensure the raw material is always fully recycled. We encourage all fixtures to be returned to us so we can **ReGen** or **recycle**.

ACCESSORIES



Maxi Commissioning Tool

ACCS-TOOL-MAXI



Maxi Snoot
Adjustable ONLY

ACCS-MX-SNOOT



Maxi Trimless Bung
Trimless ONLY

ACCS-MX-EE-BUNG

INSERTS

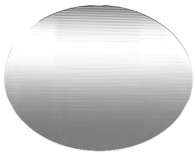

Elliptical Insert

ACCS-MX-EL



Asymmetric Insert

ACCS-MX-AS



Softening Insert

ACCS-MX-SL

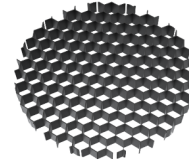

Honey Comb Insert

ACCS-MX-HC

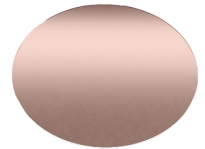

Colour Change Insert

ACCS-MX-FILTER18K
ACCS-MX-FILTER22K
ACCS-MX-FILTER24K
ACCS-MX-FILTER25K

FINISHES

Every element of your light can be finished in any of the options below, or RAL colour:

PLATED (Interior ONLY)

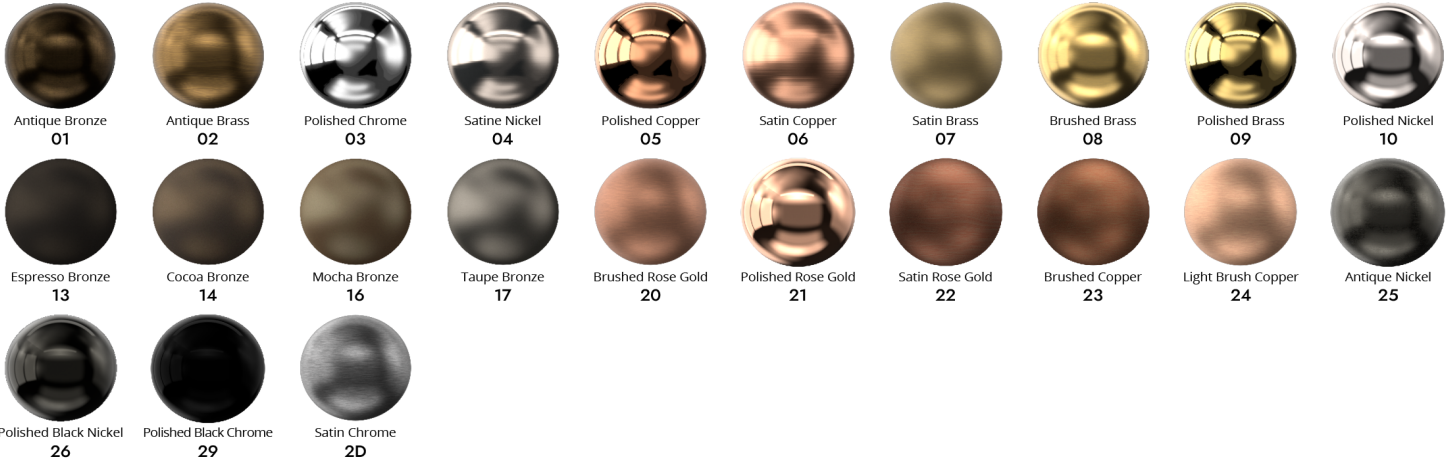

ANODISED (Interior ONLY)

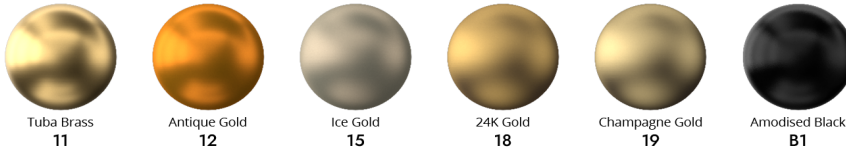

SPECIALITY PLATED (Interior ONLY)

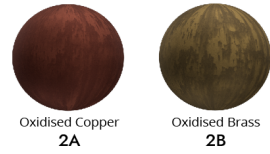

POWDER COAT (Interior & Exterior)



METAL POWDER COAT (Interior & Exterior)

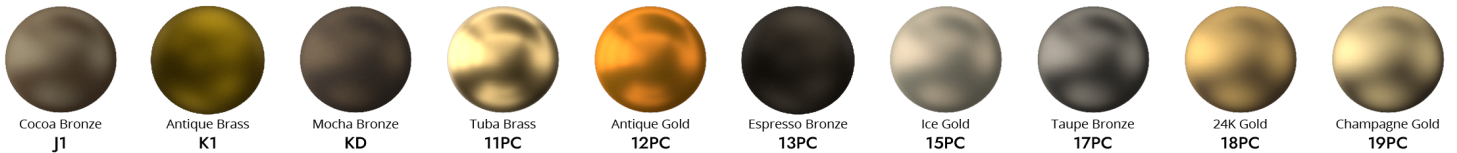

MARINE GRADE (Interior, Exterior & Harsh Environment)

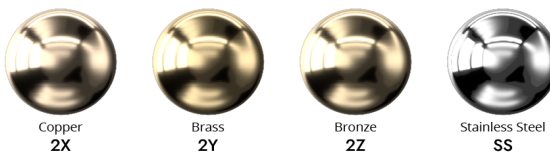

SPECIALITY POWDER COAT (Interior & Exterior)

