



PHOS
ENGINEERING LIGHT

NANO PUCK SQUARE

STANDARD



1 & 3W

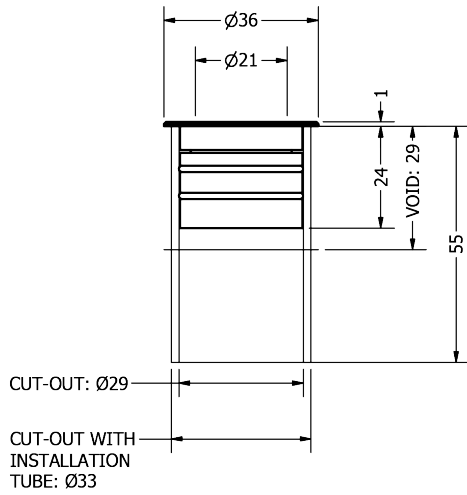

TECHNICAL SPECIFICATIONS

CCT	2700K							
Wattage	1W				3W			
BeamAngle	20°	30°	40°	55°	20°	30°	40°	55°
Luminaire Lumens (lm)	106	106	91	90	254	250	219	226
Circuit Watts (c/W)	2.6	2.6	2.6	2.6	5.7	5.7	5.7	5.7
LuminaireEfficacy (l/cW)	40	41	35	35	45	44	38	39
Luminance (Cd)	579	307	131	97	1395	733	323	240
Forward Volatage (Vf)	2.78	2.78	2.78	2.78	2.97	2.97	2.97	2.97
Current (mA)	350	350	350	350	1050	1050	1050	1050

CCT	3000K							
Wattage	1W				3W			
BeamAngle	20°	30°	40°	55°	20°	30°	40°	55°
Luminaire Lumens (lm)	111	119	95	97	217	266	229	233
Circuit Watts (c/W)	2.7	2.6	2.7	2.7	5.7	5.7	5.8	5.8
LuminaireEfficacy (l/cW)	42	46	35	37	38	47	40	40
Luminance (Cd)	611	343	134	102	994	835	332	252
Forward Volatage (Vf)	2.78	2.78	2.78	2.78	2.97	2.97	2.97	2.97
Current (mA)	350	350	350	350	1050	1050	1050	1050

Binning	2 step MacAdams
CRI	90+
TM-30-15	Rf89.97 - Rg98.64
Lumen Maintenance	LM80
Lifetime	50,000 hours
Dimming	Mains Dim, DALI, CASAMBI, 0-10V, Non-dim

LIGHT CONES

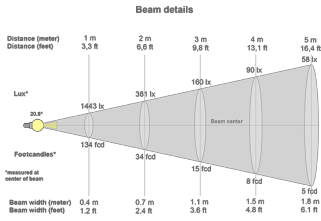

20°

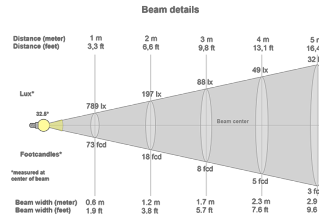

30°

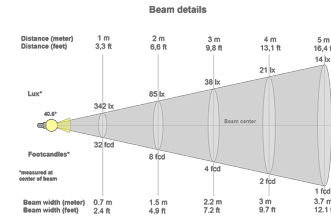

40°

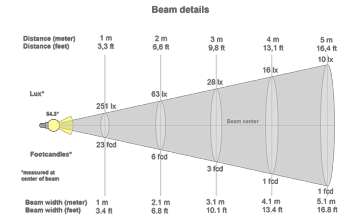

55°

POLAR CURVES

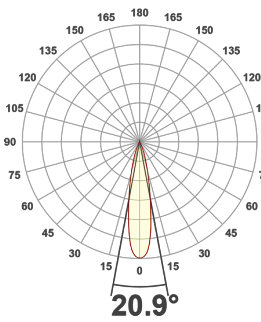

20°

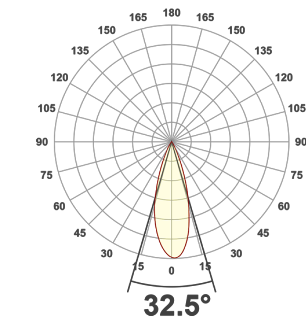

30°

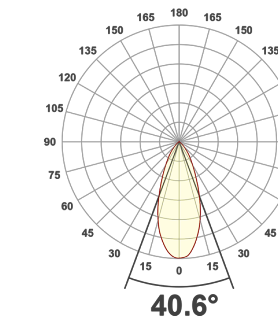

40°

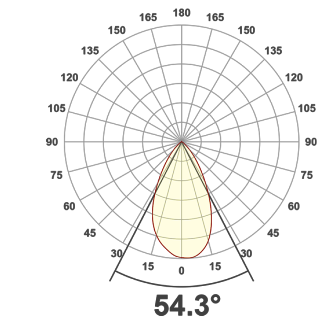

55°

PART CODE BUILDER

Example Code: NA-PK-SQ-WT-STD1-27-90-20-350

Family	Variant	Bezel Finish	Engine	Power	CCT	CRI	Beam Angle	Driver Current
NA	PK-SQ	WT	STD	1W	27K	90	20°	350mA
		BT		3W	30K		30°	1050mA
		*C					40°	
							55°	

REGENERATION FOR GENERATIONS



View ReGen Doc



TAKE

Sourcing material locally



MAKE

Responsible manufacture



WASTE

Lifetime duty of care



SOFT TM66 RESULTS

Category	Points Scored	MAX Possible Points	Assessment
Product Design	111.0	134.0	3.3
Manufacturing	35.0	46.5	3.0
Materials	11.0	24.0	1.8
Ecosystem	36.0	43.0	3.3
Overall Performance	193.0	247.5	2.9
2.5 to 4.0	Excellent circularity		

TM65 Available upon request

Embodied carbon in building services

WE ENCOURAGE ALL FIXTURES TO BE RETURNED TO US SO WE CAN REGEN OR RECYCLE.

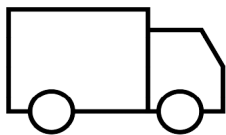

If a product has failed or has become EOL, we can arrange collection of the interchangeable light engines and associated drivers. Once received, we will review the engine to see if it can be **ReGenerated** or **recycled**.



If we can **ReGenerate** the light engine, we will only need to replace the faulty part of the fitting, which can then be restored to life, utilising all of our original optics and bezels.

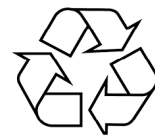

If the unit is beyond the point of repair, we will ensure the raw material is always fully recycled. We encourage all fixtures to be returned to us so we can **ReGen** or **recycle**.

ACCESSORIES



Nano Installation Tube
NOT available for spring versions

ACCS-NA-TUBE

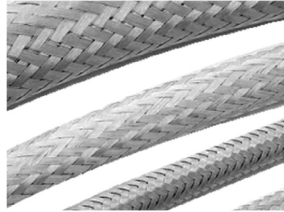

Exterior Cable Sleeve

ACCS-E-CABLESLEEVE-5MM

INSERTS



Elliptical Insert
NOT available for square versions

EL



Asymmetric Insert
NOT available for square versions

AS



Softening Insert

SL

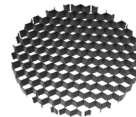

Honeycomb Insert
NOT available for puck

HC



Halfmoon Insert
NOT available for square versions

HM



Colour Change Insert

CCT: 18K

CCT: 22K

CCT: 24K

CCT: 25K

FINISHES

Every element of your light can be finished in any of the options below, or RAL colour:

PLATED (Interior ONLY)

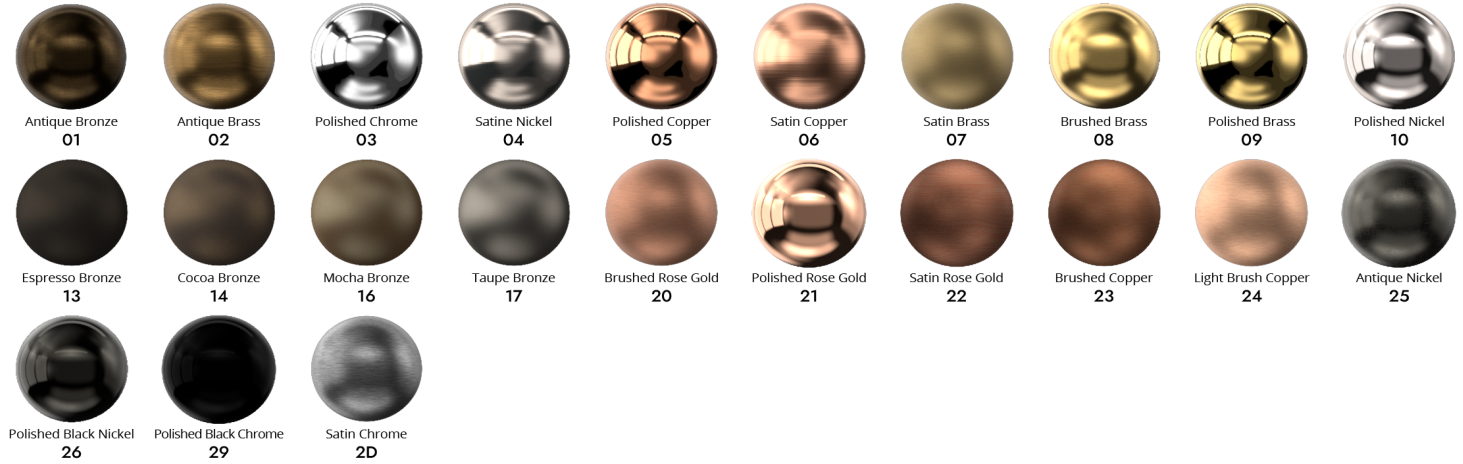

ANODISED (Interior ONLY)

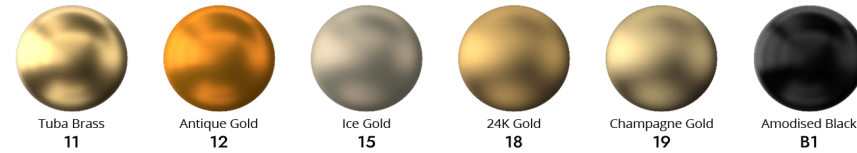

SPECIALITY PLATED (Interior ONLY)



POWDER COAT (Interior & Exterior)



METAL POWDER COAT (Interior & Exterior)

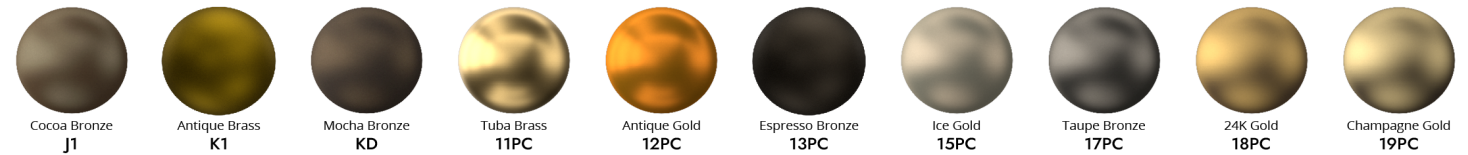

MARINE GRADE (Interior, Exterior & Harsh Environment)



SPECIALITY POWDER COAT (Interior & Exterior)

