

NEKO / FUSION Linear System

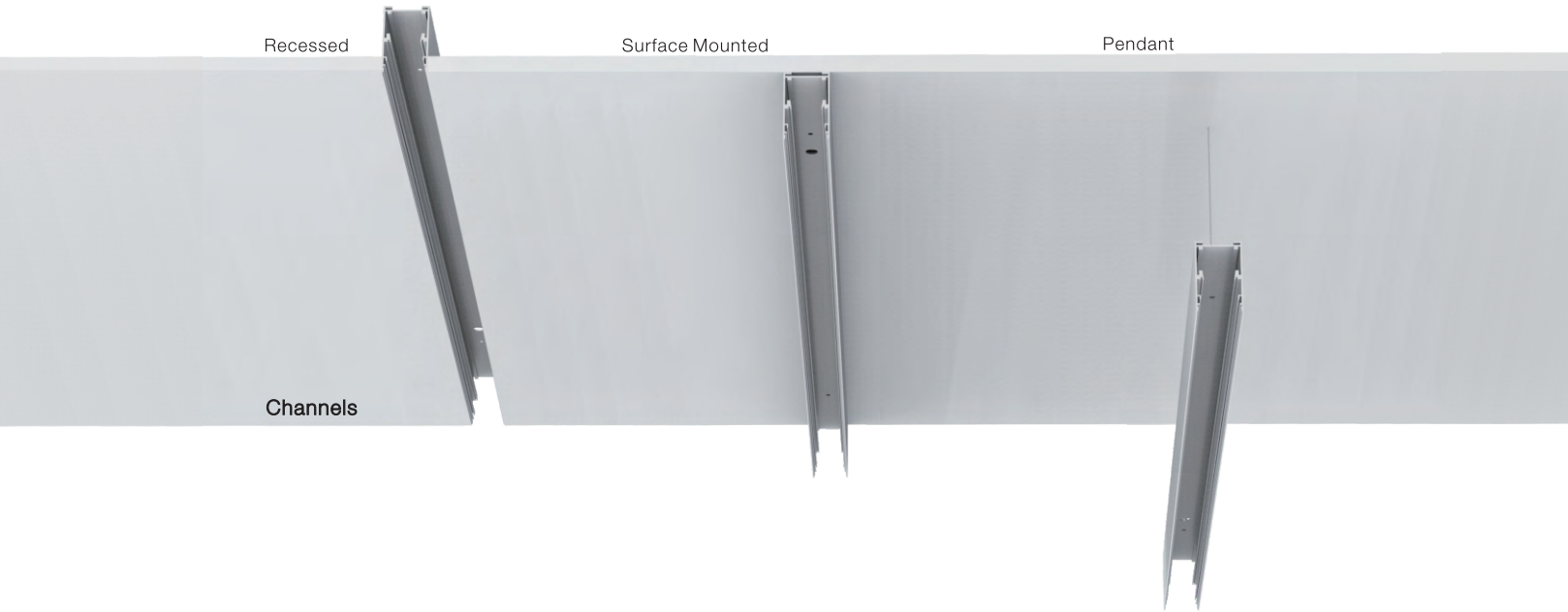

Inserts



FUSION Module
(FF/ FW/ FS/ FG)



Accent Light Module
(300mm)



General Light Module
(600mm)



Wall Washer Module
(608mm)



Spot Light Module
(300mm)



Uplight Module
(1070mm/ 1605mm)

Covers



Blind Cover



Opal Cover



Flexible Opal Cover

Corner Modules and Linear Connector

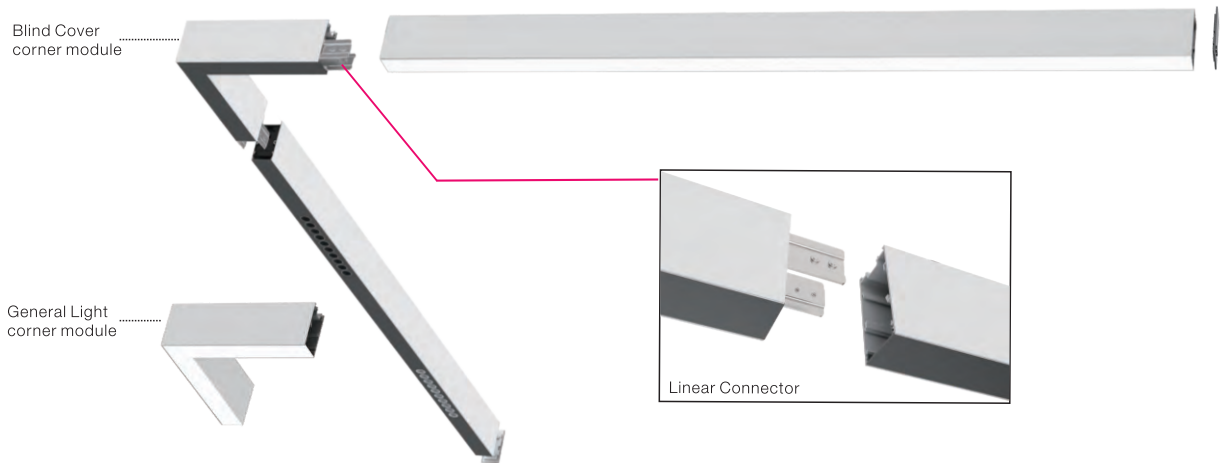

System details

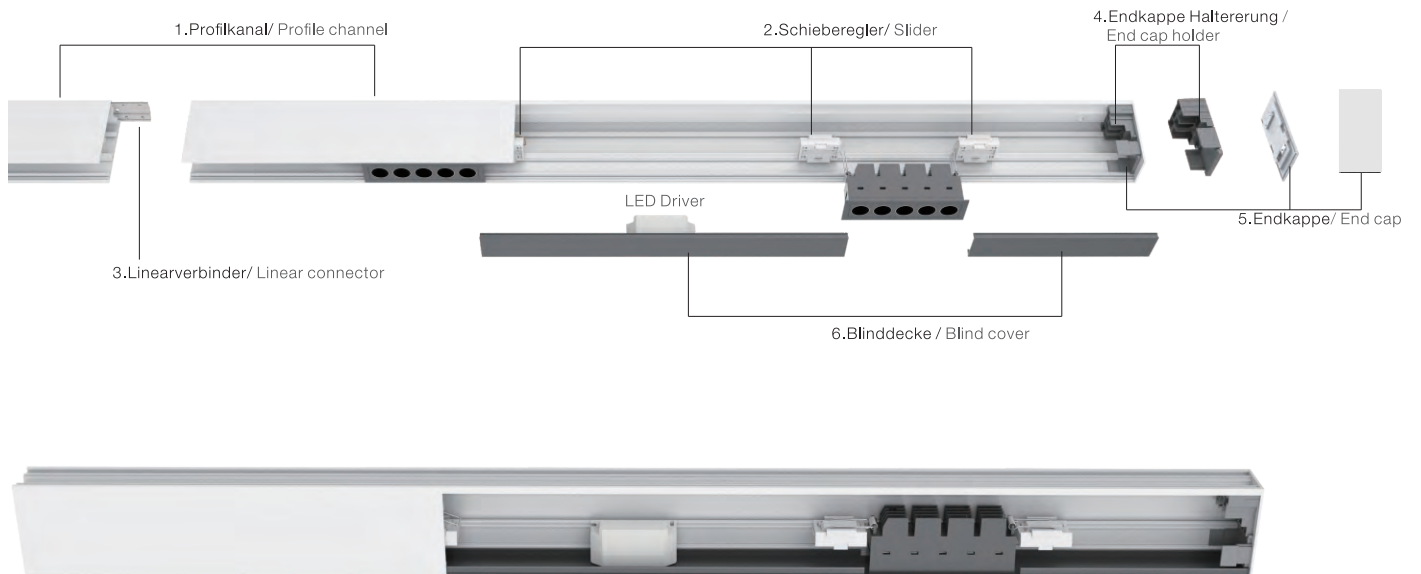

Intelligentes Linear-Profildesign
Einfachste Installation der Fusion-Einbauleuchte in den Profilkanal

Smart linear profile design
Easy to install fusion downlight into profile channel

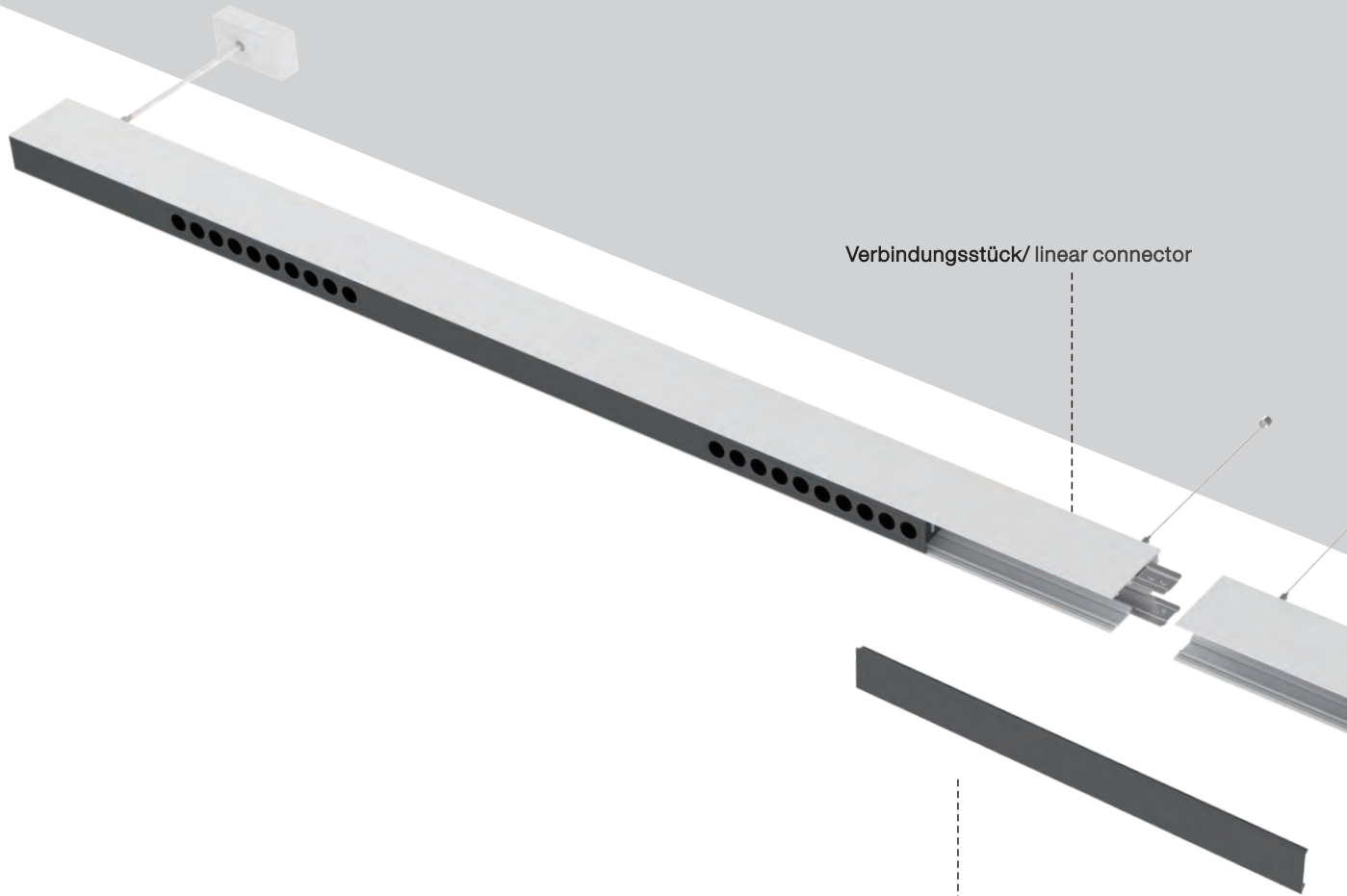

Verbindungsstück/ linear connector

Blindabdeckung mit kundenspezifischer Länge für eine nahtlose Verbindung

Blind cover with customized length providing seamless connection



230mm

290mm

460mm

290mm

460mm

Linearverbinder und Blindabdeckung erfüllen eine nahtlose Verbindung.
Gleicher Abstand kann zwischen jeder Fusion Einbauleuchte eingestellt werden

Linear connector and blind cover fulfill seamless connection
Equal distance can be set between each Fusion downlight

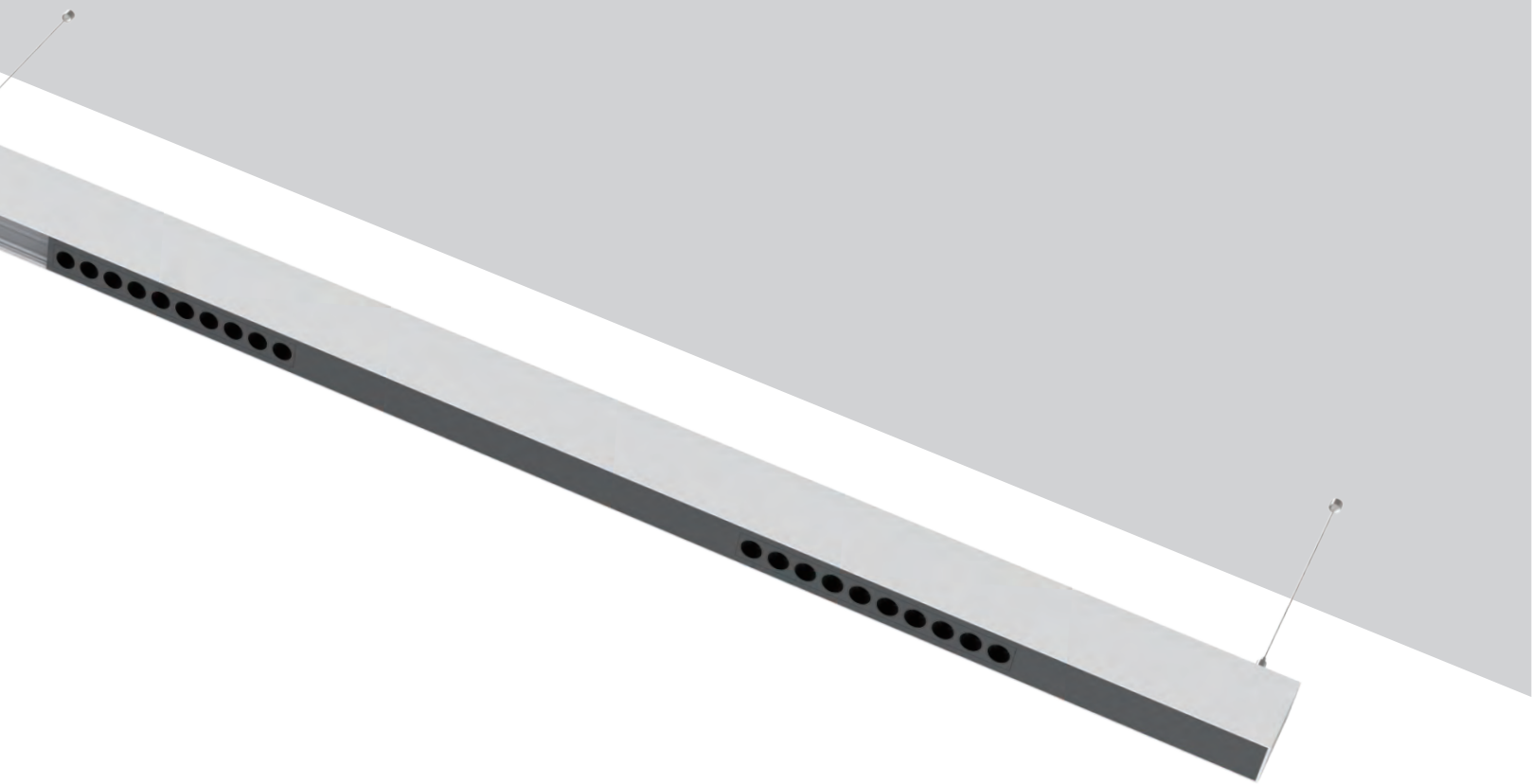

NEKO / FUSION Linear System

Linear Light module

General Light Module

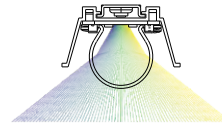
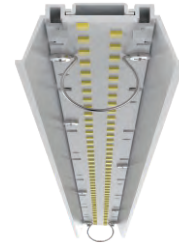

GL600
 Linkable extruded aluminium
 for continuous linear light
 594mm for different system
 Opal cover can be customized length

11W |
 CRI80 |
 2700K |
 3000K |
 4000K |
 105° |
 SAMSUNG |
 50,000h@L80B10 |
 5 YEAR |
 GUARANTEE |
 CB |
 CE

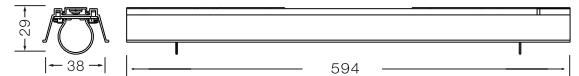

LED Power	System Power	LED Voltage	LED Current	CRI	CCT	Beam	LED Output	System Output	Model				
11 W	13 W	46V	250 mA	80	2700K	105°	1400lm	1000lm	GL600-11W-827-105D				
						105°	1500lm	1100lm	GL600-11W-830-105D				
						105°	1600lm	1200lm	GL600-11W-840-105D				
				90	2700K	105°	2000lm	1500lm	GL600-11W-827-105D				
						105°	2100lm	1600lm	GL600-11W-830-105D				
						105°	2300lm	1700lm	GL600-11W-840-105D				
				16 W	18 W	46V	350 mA	80	2700K	105°	1400lm	1000lm	GL600-16W-827-105D
										105°	1500lm	1100lm	GL600-16W-830-105D
										105°	1600lm	1200lm	GL600-16W-840-105D
90	2700K	105°	1900lm					1500lm	GL600-16W-827-105D				
		105°	2100lm					1600lm	GL600-16W-830-105D				
		105°	2300lm					1700lm	GL600-16W-840-105D				

Code Remark: X=F(ON-OFF) X=P(Phase Dim) X=A(1-10V Dim) X=D(DALI Dim)

Light Distribution

3000K

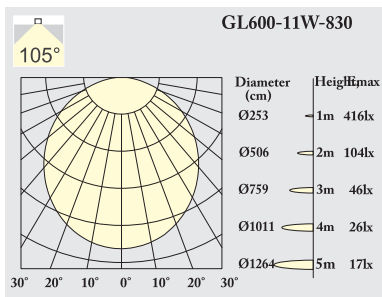

For more info see: www.nekolighting.com

NEKO / FUSION Linear System

Linear Light module

Wallwasher Module



WW600

Uniform wall washer effect
600mm for different system

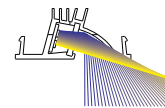

LED Power	System Power	LED Voltage	LED Current	CRI	CCT	Beam	LED Output	System Output	Model				
11 W	13 W	46V	250 mA	80	2700K	WW	1400lm	1000lm	WW600-11W-827				
					3000K	WW	1500lm	1100lm	WW600-11W-830				
					4000K	WW	1600lm	1200lm	WW600-11W-840				
				90	2700K	WW	1900lm	1500lm	WW600-11W-827				
					3000K	WW	2100lm	1600lm	WW600-11W-830				
					4000K	WW	2300lm	1700lm	WW600-11W-840				
				16 W	18 W	46V	350 mA	80	2700K	WW	1400lm	1000lm	WW600-16W-827
									3000K	WW	1500lm	1100lm	WW600-16W-830
									4000K	WW	1600lm	1200lm	WW600-16W-840
90	2700K	WW	1900lm					1500lm	WW600-16W-827				
	3000K	WW	2100lm					1600lm	WW600-16W-830				
	4000K	WW	2300lm					1700lm	WW600-16W-840				

Code Remark: X=F(ON-OFF) X=P(Phase Dim) X=A(1-10V Dim) X=D(DALI Dim)

Light Distribution

3000K

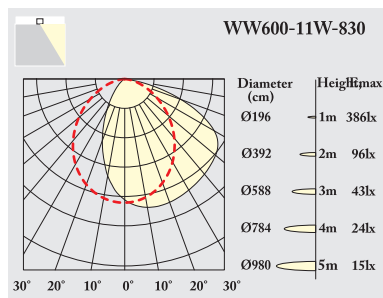

For more info see: www.nekolighting.com

NEKO / FUSION Linear System

Linear Light module

Spot Light Module

SL300-2S-8W



8W | CRI80 | 2700K | 3000K | 4000K | CRI90 | 12° | 24° | 30° | CREE | UGR < 19 | IP 40 | 50,000h@L80B10 | YEARS GUARANTEE | CB | CE

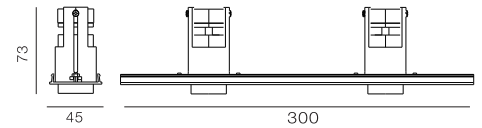

LED Power	System Power	LED Voltage	LED Current	CRI	CCT	Beam	LED Output	System Output	Model	
8 W	10 W	24V	350 mA	80	2700K	12°	850lm	650lm	SL300-2S-8W-827-12D	
						24°	850lm	650lm	SL300-2S-8W-827-24D	
						30°	850lm	650lm	SL300-2S-8W-827-30D	
						3000K	12°	900lm	700lm	SL300-2S-8W-830-12D
							24°	900lm	700lm	SL300-2S-8W-830-24D
							30°	900lm	700lm	SL300-2S-8W-830-30D
						4000K	12°	950lm	750lm	SL300-2S-8W-840-12D
							24°	950lm	750lm	SL300-2S-8W-840-24D
							30°	950lm	750lm	SL300-3S-8W-840-30D

Code Remark: X=F(ON-OFF) X=P(Phase Dim) X=A(1-10V Dim) X=D(DALI Dim)

Light Distribution

3000K

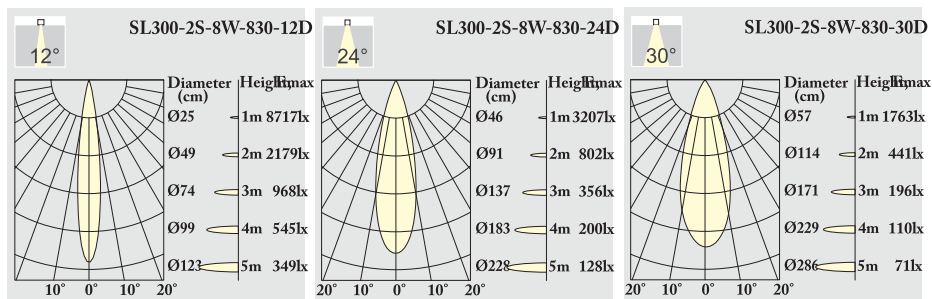

For more info see: www.nekolighting.com



NEKO / FUSION Linear System

Linear Light module

Accent Light Module

AL300-13W

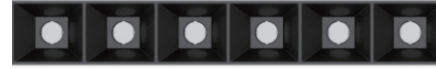

AL300
Different lens for beam control
Low glare contributed by black baffle

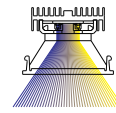

13W | CRI80 | 2700K | 3000K | 4000K | 15° | 30° | CREE | UGR < 19 | 50,000h@L80B10 | 5 YEAR GUARANTEE | CB | CE | 33 | 45 | 300

LED Power	System Power	LED Voltage	LED Current	CRI	CCT	Beam	LED Output	System Output	Model	
13 W	15 W	18 V	700 mA	80	2700K	15°	1300lm	1000lm	AL300-26W-827-15D	
						30°	1300lm	1000lm	AL300-26W-827-30D	
						3000K	15°	1400lm	1100lm	AL300-26W-830-15D
						30°	1400lm	1100lm	AL300-26W-830-30D	
						4000K	15°	1500lm	1200lm	AL300-26W-840-15D
						30°	1500lm	1200lm	AL300-26W-840-30D	

Code Remark: X=F(ON-OFF) X=P(Phase Dim) X=A(1-10V Dim) X=D(DALI Dim)

Light Distribution

3000K

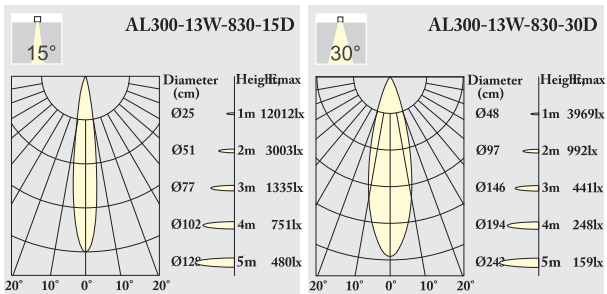

For more info see: www.nekolighting.com

NEKO / FUSION Linear System

Linear Light module

Up Light Module

UL1200-11W/ UL1800-16W



Up Light

11W | CRI80 | 2700K
16W | CRI90 | 3000K
 4000K

CREE 50,000h@L80B10

CB CE

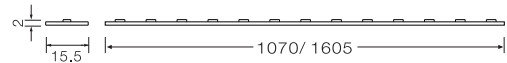

LED Power	System Power	LED Voltage	LED Current	CRI	CCT	Beam	LED Output	System Output	Model
11 W	13 W	46 V	250 mA	80	2700K	110°	2000lm	1500lm	UL1200-11W-827-110D
						3000K	2100lm	1600lm	UL1200-11W-830-110D
						4000K	2300lm	1700lm	UL1200-11W-840-110D
16 W	18 W	46 V	350 mA	80	2700K	110°	3000lm	2000lm	UL1800-16W-827-110D
						3000K	3200lm	2200lm	UL1800-16W-830-110D
						4000K	3400lm	2400lm	UL1800-16W-840-110D

Code Remark: X=F(ON-OFF) X=P(Phase Dim) X=A(1-10V Dim) X=D(DALI Dim)

Light Distribution

3000K

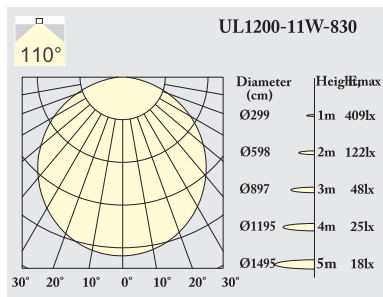

For more info see: www.nekolighting.com

NEKO/FUSION Linear System



Available mounting type

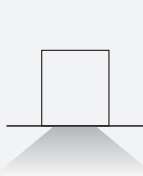

Recessed

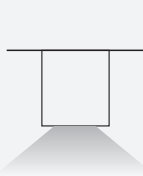

Surface Mounted

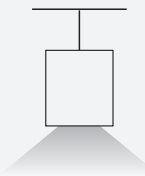

Pendant

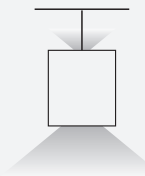

Pendant with Uplight



NEKO/FUSION Linear System





NEKO/FUSION Linear System
FL1500-2*FF10/ FL1200-2*FF5



44W CRI80 2700K
 22W CRI90 3000K
 4000K

24° 40°

CREE

50,000h@L80B10

UGR < 10

IP 20

5 YEARS GUARANTEE

CB CE

1500/1200

LED Power	System Power	LED Voltage	LED Current	CRI	CCT	Beam	LED Output	System Output	Length	Model	
44 W	48 W	31+31V	700 mA	80	2700K	24°	5000lm	3400lm	1500mm	FL1500(X)-2*FF10-44W-827-24D	
						40°	5000lm	3400lm	1500mm	FL1500(X)-2*FF10-44W-827-40D	
						3000K	24°	5200lm	3600lm	1500mm	FL1500(X)-2*FF10-44W-830-24D
							40°	5200lm	3600lm	1500mm	FL1500(X)-2*FF10-44W-830-40D
						4000K	24°	5600lm	3800lm	1500mm	FL1500(X)-2*FF10-44W-840-24D
							40°	5600lm	3800lm	1500mm	FL1500(X)-2*FF10-44W-840-40D
22 W	26 W	16+16V	700 mA	80	2700K	24°	2400lm	1700lm	1200mm	FL1200(X)-2*FF5-22W-827-24D	
						40°	2400lm	1700lm	1200mm	FL1200(X)-2*FF5-22W-827-40D	
						3000K	24°	2600lm	1800lm	1200mm	FL1200(X)-2*FF5-22W-830-24D
							40°	2600lm	1800lm	1200mm	FL1200(X)-2*FF5-22W-830-40D
						4000K	24°	2800lm	1900lm	1200mm	FL1200(X)-2*FF5-22W-840-24D
							40°	2800lm	1900lm	1200mm	FL1200(X)-2*FF5-22W-840-40D

Remark: X= P (Pendant) X= S (Surface mounted) X= R (Recessed mounted)



NEKO/FUSION Linear System
FL1800-GL1800/ FL1200-GL1200



32W CRI80 2700K 22W CRI90 3000K 4000K 105° SAMSUNG 50,000h@L80B10 IP 20 5 YEARS GUARANTEE CB CE

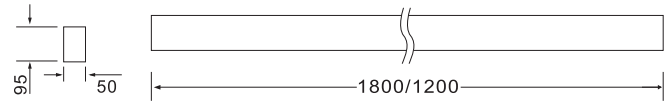

LED Power	System Power	LED Voltage	LED Current	CRI	CCT	Beam	LED Output	System Output	Length	Model
32 W	36 W	46V	700 mA	80	2700K	105°	4600lm	3400lm	1800mm	FL1800(X)-GL1800-32W-827
					3000K	105°	4800lm	3600lm	1800mm	FL1800(X)-GL1800-32W-830
					4000K	105°	5000lm	3800lm	1800mm	FL1800(X)-GL1800-32W-840
48 W	52 W	46V	700+350 mA	80	2700K	105°	6200lm	5000lm	1800mm	FL1800(X)-GL1800-48W-827
					3000K	105°	6400lm	5200lm	1800mm	FL1800(X)-GL1800-48W-830
					4000K	105°	6600lm	5400lm	1800mm	FL1800(X)-GL1800-48W-840

22 W	26 W	46V	500 mA	80	2700K	105°	3200lm	2200lm	1200mm	FL1200(X)-GL1200-22W-827
					3000K	105°	3400lm	2400lm	1200mm	FL1200(X)-GL1200-22W-830
					4000K	105°	3600lm	2600lm	1200mm	FL1200(X)-GL1200-22W-840
32 W	36 W	46V	700 mA	80	2700K	105°	4600lm	3400lm	1200mm	FL1200(X)-GL1200-32W-827
					3000K	105°	4800lm	3600lm	1200mm	FL1200(X)-GL1200-32W-830
					4000K	105°	5000lm	3800lm	1200mm	FL1200(X)-GL1200-32W-840

Remark: X= P (Pendant) X= S (Surface mounted) X= R (Recessed mounted)

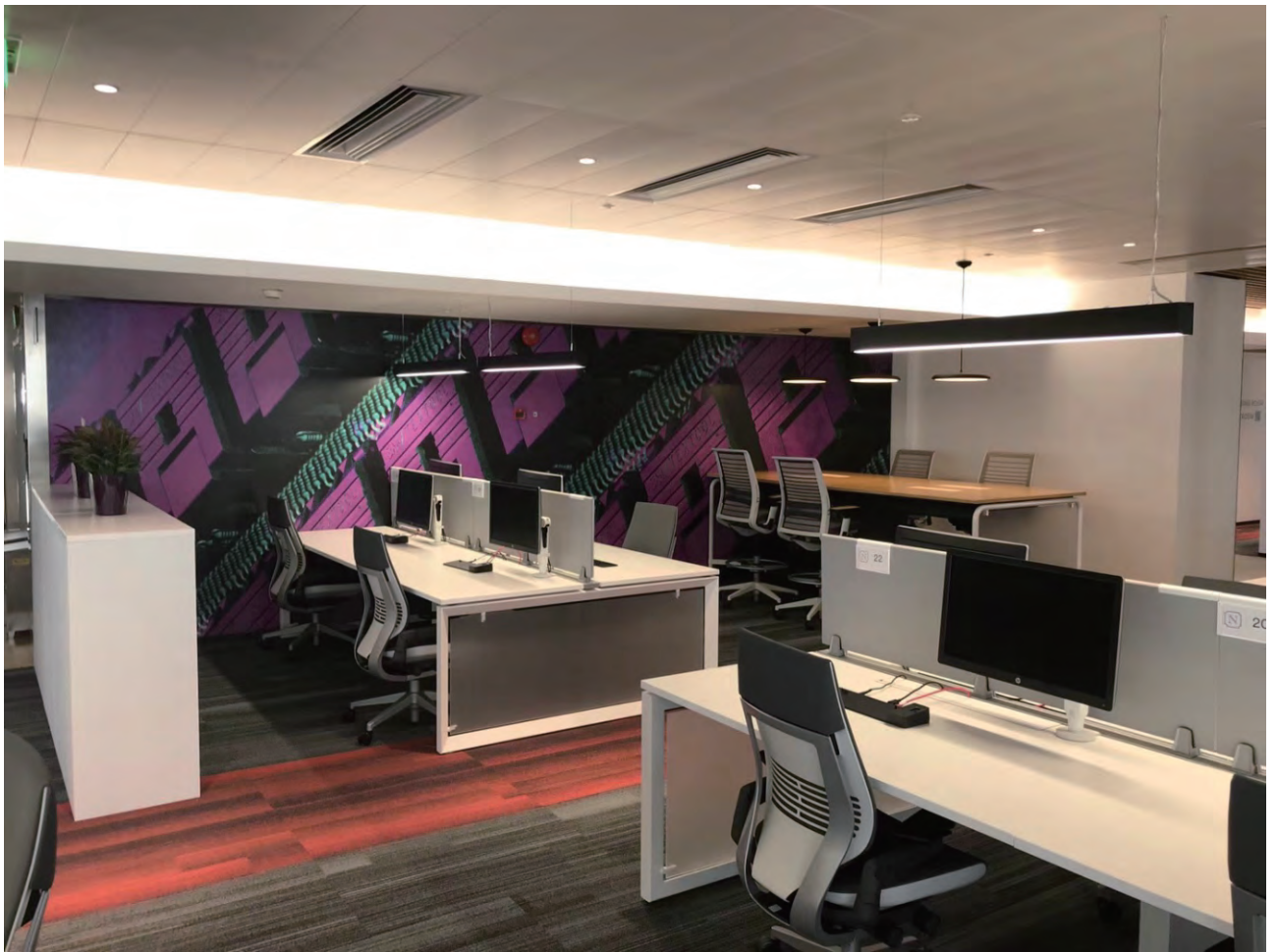

NEKO/FUSION Linear System
FL1800-WW1800/ FL1200-WW1200

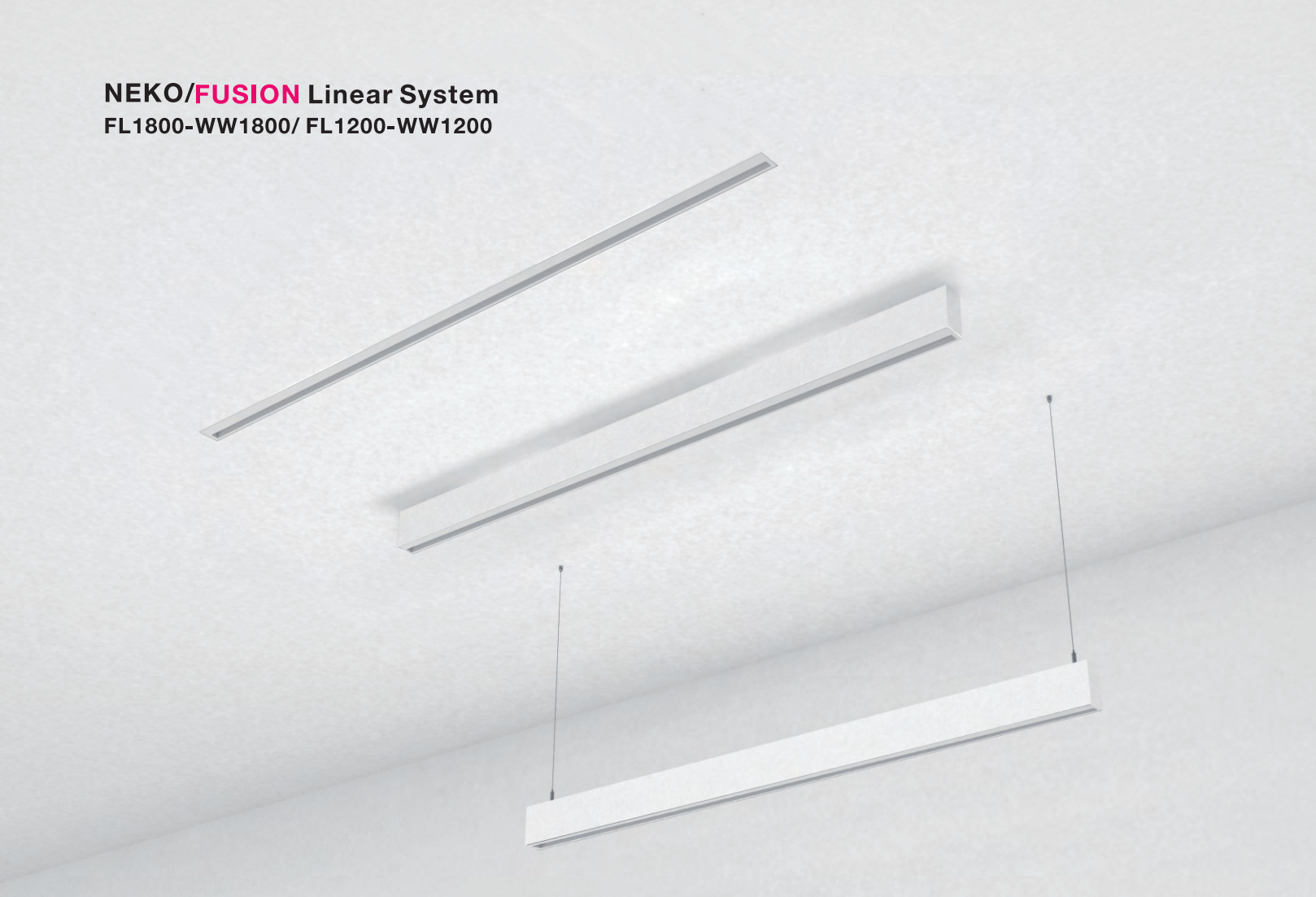

32W CRI80 2700K
 22W CRI90 3000K
 4000K

SAMSUNG
 50,000h@L80B10

IP 20

5 YEARS
 GUARANTEE

CB CE

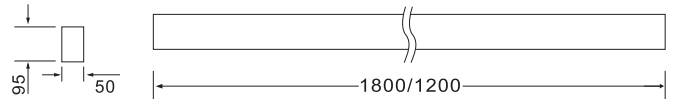

LED Power	System Power	LED Voltage	LED Current	CRI	CCT	Beam	LED Output	System Output	Length	Model
32 W	36 W	46V	700 mA	80	2700K	WW	4600lm	2300lm	1800mm	FL1800(X)-WW1800-32W-827
						WW	4800lm	2500lm	1800mm	FL1800(X)-WW1800-32W-830
						WW	5000lm	2700lm	1800mm	FL1800(X)-WW1800-32W-840
48 W	52 W	46V	700+350 mA	80	2700K	WW	6200lm	3300lm	1800mm	FL1800(X)-WW1800-48W-827
						WW	6400lm	3500lm	1800mm	FL1800(X)-WW1800-48W-830
						WW	6600lm	3700lm	1800mm	FL1800(X)-WW1800-48W-840

22 W	26 W	46V	500 mA	80	2700K	WW	3200lm	1700lm	1200mm	FL1200(X)-WW1200-22W-827
						WW	3400lm	1800lm	1200mm	FL1200(X)-WW1200-22W-830
						WW	3600lm	1900lm	1200mm	FL1200(X)-WW1200-22W-840
32 W	36 W	46V	700 mA	80	2700K	WW	4600lm	2300lm	1200mm	FL1200(X)-WW1200-32W-827
						WW	4800lm	2500lm	1200mm	FL1200(X)-WW1200-32W-830
						WW	5000lm	2700lm	1200mm	FL1200(X)-WW1200-32W-840

Remark: X= P (Pendant) X= S (Surface mounted) X= R (Recessed mounted)



NEKO/FUSION Linear System
FL1200-2*AL300

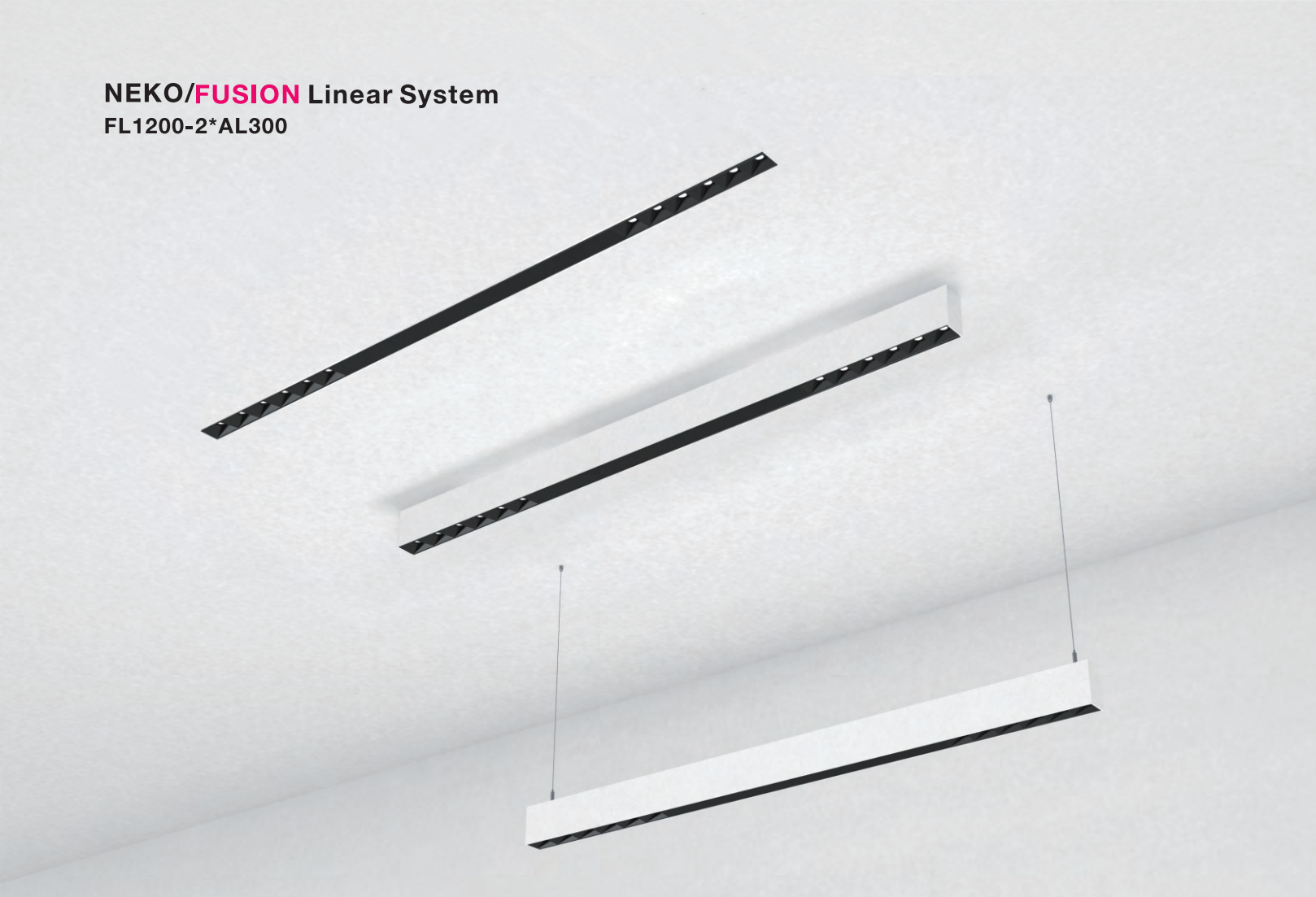

26W | CRI80 | 2700K | 3000K | 4000K | 15° | 30° | CREE | 50,000h@L80B10 | UGR < 19 | IP20 | 5 YEARS GUARANTEE | CB | CE |

LED Power	System Power	LED Voltage	LED Current	CRI	CCT	Beam	LED Output	System Output	Length	Model						
26 W	30 W	36 V	700 mA	80	2700K	15°	2800lm	2000lm	1200mm	FL1200(X)-2*AL300-26W-827-15D						
						30°	2800lm	2000lm	1200mm	FL1200(X)-2*AL300-26W-827-30D						
						3000K	15°	3000lm	2200lm	1200mm	FL1200(X)-2*AL300-26W-830-15D					
							30°	3000lm	2200lm	1200mm	FL1200(X)-2*AL300-26W-830-30D					
						4000K	15°	3400lm	2400lm	1200mm	FL1200(X)-2*AL300-26W-840-15D					
							30°	3400lm	2400lm	1200mm	FL1200(X)-2*AL300-26W-840-30D					
						26 W	30 W	36 V	700 mA	80	2700K	15°	2800lm	2000lm	1500mm	FL1500(X)-2*AL300-26W-827-15D
												30°	2800lm	2000lm	1500mm	FL1500(X)-2*AL300-26W-827-30D
3000K	15°	3000lm	2200lm	1500mm	FL1500(X)-2*AL300-26W-830-15D											
	30°	3000lm	2200lm	1500mm	FL1500(X)-2*AL300-26W-830-30D											
4000K	15°	3400lm	2400lm	1500mm	FL1500(X)-2*AL300-26W-840-15D											
	30°	3400lm	2400lm	1500mm	FL1500(X)-2*AL300-26W-840-30D											

Remark: X= P (Pendant) X= S (Surface mounted) X= R (Recessed mounted)

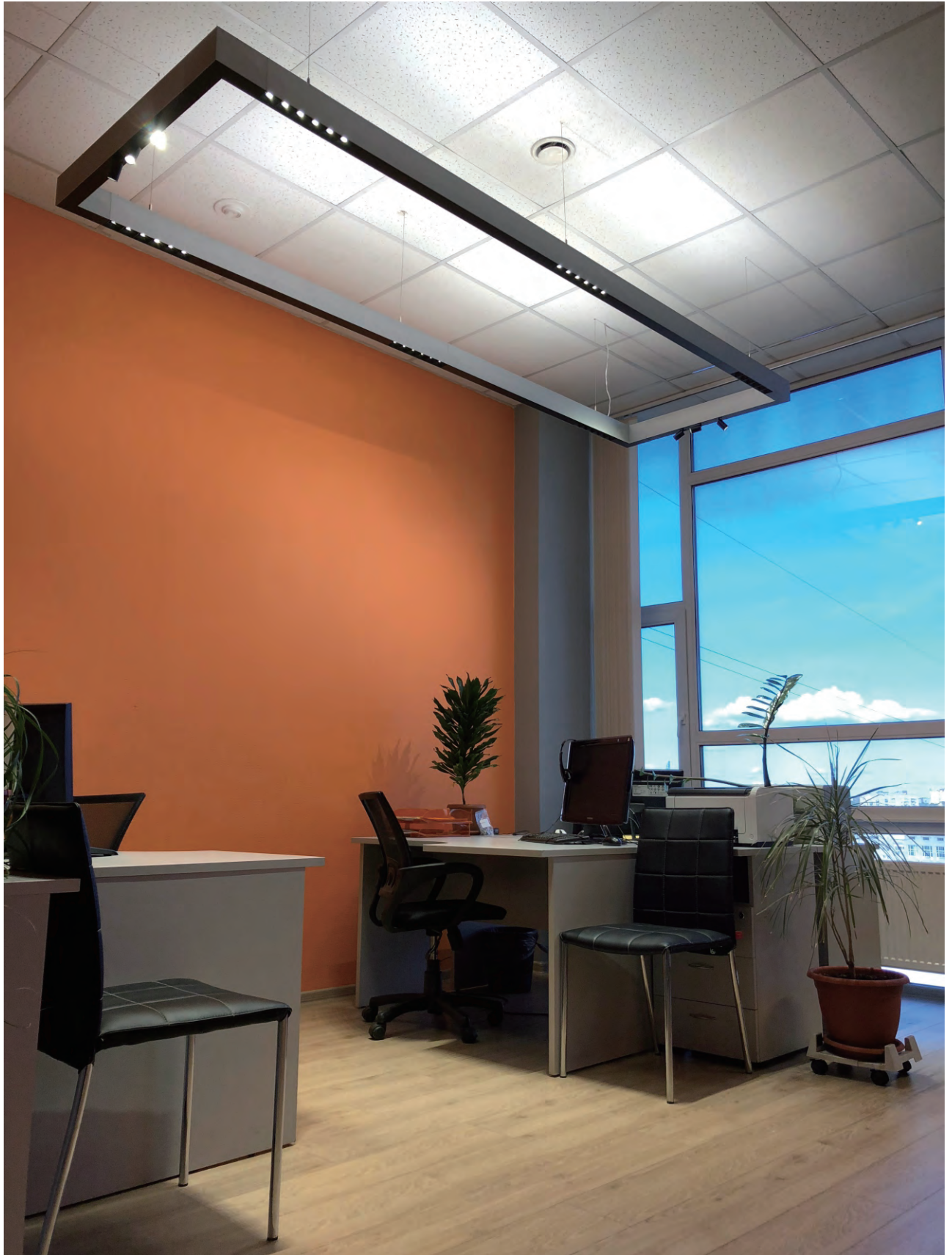

NEKO/FUSION Linear System
FL1200-2*AL300+GL600



37W | CRI80 | 2700K | 105° | 105° | SAM SUNG | CREE | UGR < 19 | IP 20 | 5 YEARS GUARANTEE | CB | CE | 0.5 | 50 | 300 | 1200 | 300

LED Power	System Power	LED Voltage	LED Current	CRI	CCT	Beam	LED Output	System Output	Model
37 W	41 W	47 V	700 mA	80	2700K	15°+105°	3800lm	2800lm	FL1200(X)-2*AL300+GL600-37W-827-15D
						30°+105°	3800lm	2800lm	FL1200(X)-2*AL300+GL600-37W-827-30D
						3000K 15°+105°	4100lm	3000lm	FL1200(X)-2*AL300+GL600-37W-830-15D
						30°+105°	4100lm	3000lm	FL1200(X)-2*AL300+GL600-37W-830-30D
						4000K 15°+105°	4400lm	3200lm	FL1200(X)-2*AL300+GL600-37W-840-15D
						30°+105°	4400lm	3200lm	FL1200(X)-2*AL300+GL600-37W-840-30D

Remark: X= P (Pendant) X= S (Surface mounted) X= R (Recessed mounted)



NEKO/FUSION Linear System
More modules combination available

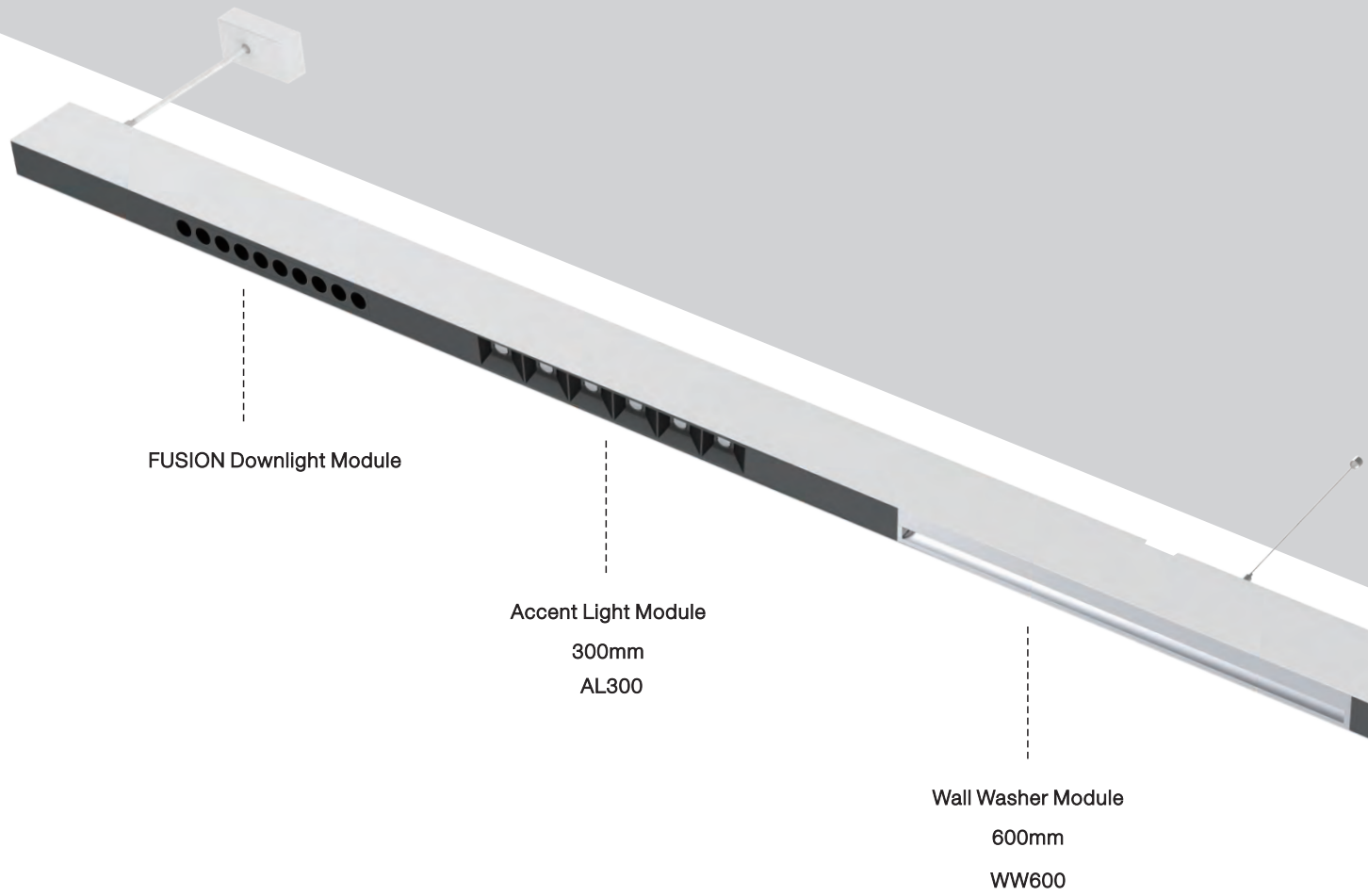

Linear System with more modules combination available.
All available with Suspended, surface mounted and recessed mounted versions.

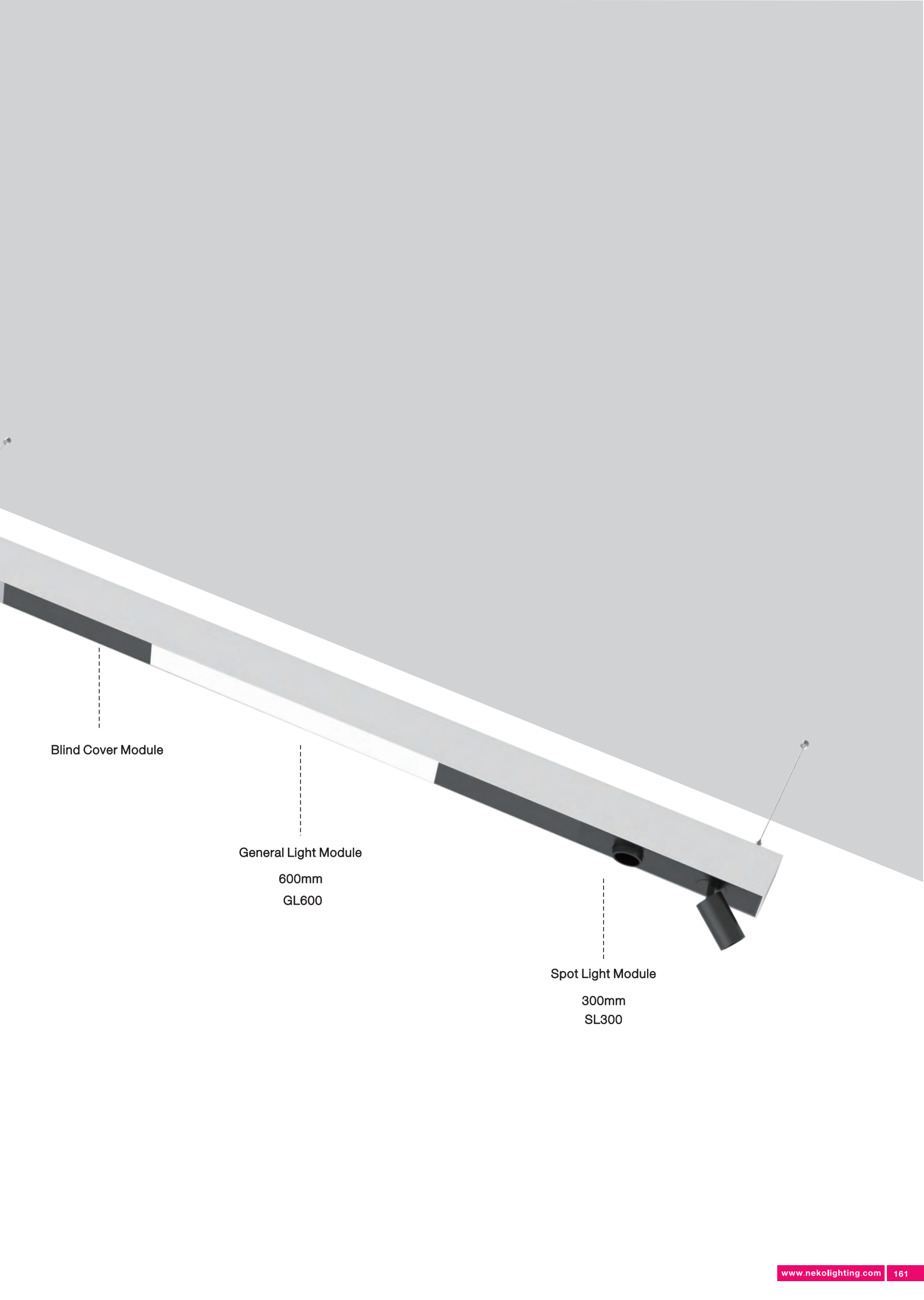

Blind Cover Module

General Light Module

600mm

GL600

Spot Light Module

300mm

SL300