



With its square form factor, advanced optics providing perfect beam control, and durable body VEGA family stand out for highlighting architectural details in high-end projects.

- Equipped with HEPER's Hybrid (HYB) module [S] [N]
- 4 different light distribution options from very narrow to wide
- Well-defined beam angles with reflector and lens combined (HYB)
- +60°/-30° vertically adjustable with aim locking set screw allowing fine-tuning
- Different sizes and lumen packages in order to comply with any project needs

Product code	Product name	Light distribution	Delivered lumens flux	Rated input power	Colour temperature	Control	Weight
LF8020.693-EN	VEGA S	[S] 7°, [N] 26°, [MN] 42°, [M] 60°	606 - 1019 lm	10 W	2700 K CRI 80, 3000 K CRI 80, 4000 K CRI 70, 4000 K CRI 80	On/Off, DALI	2.07 kg
LF8021.695-EN	VEGA	[S] 7°, [N] 26°, [MN] 42°, [M] 60°	2430 - 3976 lm	35 W	2700 K CRI 80, 3000 K CRI 80, 4000 K CRI 70, 4000 K CRI 80	On/Off, DALI	6.52 kg

LF8020.693

LF8021.695

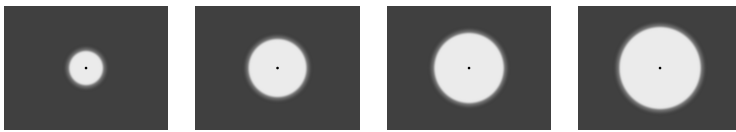
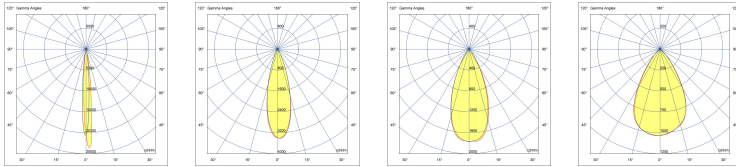
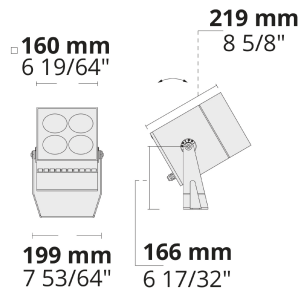
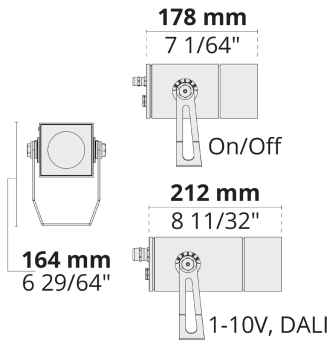

[S] Spot
[N] Narrow
[MN] Medium narrow
[M] Medium

Extras

Consult the factory

Luminaire body options

120-277V
50/60Hz

DPC

UNI

120-277V 50/60Hz

DPC

Double powder
coating

Accessories (To be ordered separately)

Optical accessories

Mounting accessories

Optical accessories

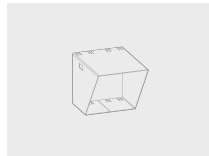
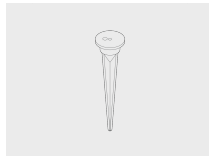
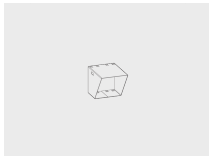

Visor for VEGA S
100708016

Spike
160405040

Visor for VEGA
100708017

