

RING 3™ - SUSPENDED

Project Name:

Fixture Type:

Fixture Code:

Quantities:



RING 3™ - SUSPENDED



RING 3™ - SUSPENDED

RING 3 is our 2nd generation circular performance pendant. Now with a slender 3" profile, the lightweight design works well as a low-hanging ambient light and is ideal for lower ceilings. The new design still delivers matchless light outputs and multiple control integrations including PoE and wellness technology including BIOS and Dim to Warm. Indirect light is available with our powerful Batwing optic which provides wider light coverage and is an effective way to add to the ambient illumination. For sound comfort, RING 3 is available with an acoustic panel up to 8', designed to absorb echo and reverberation associated with open-concept spaces, exposed concrete, open ceilings, and large windows.

GENERAL SPECIFICATION

Body and trim

Steel and aluminum.

Power cable

Silver braided.

Remote Emergency

Emergency option provides a 1.5 hour (3 hours for EU) emergency lighting facility. The remote system includes the inverter module, NiCad batteries and a remote wall/ceiling LED charge indicator and test switch (NA only) Maximum distance between wall/ceiling plate and luminaire is 15' (4.5m). Test switch fits a single gang box (not supplied).

PoE

Ring 3 can integrate into your data network via Power over Ethernet (PoE) connectivity.

Delivered Lumens

Delivered lumens & LPW based on 4000K (min 90 CRI) for White LEDs only. Data shown at MAX values.

Approvals

Damp Rated.

Finish

Powder coated.

Suspension

Steel cables. Recommended minimum mounting heights: 1ft (305mm). Maximum angle tilt 5°.

Diffusers

Opal polycarbonate direct, batwing indirect, supplied in sections.

Drivers

Integral, HPF electronic drivers for 120-277V (EU-240V).

Mechanical

Luminaires mount directly over J box (by others - North America only).

L70 @25°C (77°F)

> 50,000 hrs.

MOUNTING & OPTICS



Suspended Direct



Suspended Direct/Indirect



Acoustic



Declare



Dim to Warm



PoE



RING 3™ - SUSPENDED

HOW TO ORDER

A. LUMINAIRE

RGTP1P02 2ft, Direct, 4600 lms Direct	RGTP1P03 3ft, Direct, 6700 lms Direct	RGTP1P04 4ft, Direct, 8800 lms Direct	RGTP1P05 5ft, Direct, 11000 lms Direct
RGTP1P06 6ft, Direct, 13000 lms Direct	RGTP1P07 7ft, Direct, 15000 lms Direct	RGTP1P08 8ft, Direct, 21000 lms Direct	RGTP1P09 9ft, Direct, 24000 lms Direct
RGTP1P12 12ft, Direct, 32000 lms Direct	RGTP1P18 18ft, Direct, 48000 lms Direct	RGTP2P02 2ft, Direct/Indirect, 4600 lms Direct, 2200 lms Indirect	RGTP2P03 3ft, Direct/Indirect, 6700 lms Direct, 4400 lms Indirect
RGTP2P04 4ft, Direct/Indirect, 8800 lms Direct, 4400 lms Indirect	RGTP2P05 5ft, Direct/Indirect, 11000 lms Direct, 7300 lms Indirect	RGTP2P06 6ft, Direct/Indirect, 13000 lms Direct, 8800 lms Indirect	RGTP2P07 7ft, Direct/Indirect, 15000 lms Direct, 12000 lms Indirect
RGTP2P08 8ft, Direct/Indirect, 21000 lms Direct, 8800 lms Indirect	RGTP2P09 9ft, Direct/Indirect, 24000 lms Direct, 13000 lms Indirect	RGTP2P12 12ft, Direct/Indirect, 32000 lms Direct, 18000 lms Indirect	RGTP2P18 18ft, Direct/Indirect, 48000 lms Direct, 31000 lms Indirect

All information shown is based on white LEDs only at max values.
RGTP2P18 must be ordered with CS2 (dual circuit) if ordering direct/indirect and will be complete with 2 power cords and 1 canopy.
Recommended minimum suspension length: 1ft for white LEDs, 2ft for colored LEDs.

B. LUMENS (DIRECT)

LMA0230 2300	LMA0460 4600	LMA0670 6700	LMA0880 8800
LMA1100 11000	LMA1300 13000	LMA1500 15000	LMA2100 21000
LMA2400 24000	LMA3200 32000	LMA4800 48000	

Values shown are nominal.
Consult website for max lumens available/size.

C. LUMENS (INDIRECT)

LPG000 Not required	LMB0110 1100	LMB0220 2200	LMB0440 4400
LMB0730 7300	LMB0880 8800	LMB1200 12000	LMB1300 13000
LMB1800 18000	LMB3100 31000		

Values shown are nominal.
Consult website for max lumens available/size.

D. CRI

CR80 CRI 80+	CR90 CRI 90+
---------------------	---------------------

¹ CRI 90+ available for 8ft diameter and above, consult factory.

E. CCT (DIRECT)

CTA27 2700K ²	CTA30 3000K	CTA35 3500K	CTA40 4000K
CTA61 Dim to warm ¹			

¹ Available to special order. Not available with BIOS.

F. CCT (INDIRECT)

CTB00 Not required	CTB30 3000K	CTB35 3500K	CTB40 4000K
CTB61 Dim to warm ¹			

¹ Available to special order. Not available with BIOS.

² 2700K available for Direct version only.

G. UPLIGHT DIFFUSER

UD0 Not required	UD3 Batwing diffuser
-------------------------	-----------------------------

RING 3™ - SUSPENDED

H. VOLTAGE

V1 120/277V

V2 240V ¹

V3 347V ²

V4 Low Voltage ³

¹ Not available in North America.

² Only available with DA01 & DB01 dimming.

³ Only available with DA45 & DB45 dimming.

I. DIMMING (DIRECT)

DA01 0-10V Dimming 1.0%

DA10 0-10V Dimming 10.0%

DA45 PoE ³

¹ Only available V4 and CRI 80+.

J. DIMMING (INDIRECT)

DB00 Not required

DB01 0-10V Dimming 1.0%

DB10 0-10V Dimming 10.0%

DB45 PoE ^{1 3}

¹ DB45 only available with DA45 and V4.

K. SUSPENSION

SS1 Vertical, Integral driver

SS2 Hub, Integral driver

¹ SS2 not available for diameters of 12ft or larger.

L. FIXTURE FINISH

FA01 White

FA02 Black Metallic - Textured

FA20 Silver Metallic - Textured

FA25 Gold Metallic

FA27 Wood grain - Light Cherry

FA28 Wood grain - Dark Walnut

FA44 Midnight Blue Metallic - Textured

FA45 Copper Metallic

FA46 Charcoal Metallic - Textured

FA47 Bronze Metallic - Textured

FA52 Champagne Metallic

FA53 Red Metallic - Textured

¹ Longer than normal lead times may apply, consult factory.

M. CANOPY FINISH

CF01 White

CF02 Black Metallic - Textured

CF20 Silver Metallic - Textured

CF25 Gold Metallic

CF44 Midnight Blue Metallic - Textured

CF45 Copper Metallic

CF46 Charcoal Metallic - Textured

CF47 Bronze Metallic - Textured

CF52 Champagne Metallic

CF53 Red Metallic - Textured

N. ACOUSTIC PANEL COLOR

AP00 Not required

AP04 White

AP13 Apple Green

AP22 Blue

AP11 Light Gray

AP26 Sesame Gray

AP27 Black

Available up to 4ft. Sizes 5ft to 8ft available with visible seams, consult factory. Acoustic panels are not available for sizes of 9ft and larger.

For complimentary non-illuminating acoustic panels see our Acoustic Circles, Quads and Triangles spec pages.

Other colours available to special order. Consult factory.

O. EMERGENCY

E0 Not required

E2 Emergency system - Remote ¹

¹ Direct illumination only, not available with 347V.



RING 3™ - SUSPENDED

P. CIRCUIT

CS1 Single circuit

CS2 Dual circuit ^{1 2}

¹ RGTP1P18 must be ordered with CS2 (dual circuit) and will be complete with 2 power cords and 1 canopy.

² When ordering Remote emergency (E2), fixture will be c/w 2 power cords.

Q. CONTROLS

CO Not required

C1 Encelium/Zigbee control



RING 3™ - SUSPENDED

TECHNICAL DATA

RING 3™ - SUSPENDED

LUMINAIRE

All information shown is based on white LEDs only at max values.

RGTP2P18 must be ordered with CS2 (dual circuit) if ordering direct/indirect and will be complete with 2 power cords and 1 canopy.

Recommended minimum suspension length: 1ft for white LEDs, 2ft for colored LEDs.









Code	RGTP1P02	RGTP1P03	RGTP1P04	RGTP1P05	RGTP1P06	RGTP1P07
Size (Ft)	2	3	4	5	6	7
Light Distribution	Direct	Direct	Direct	Direct	Direct	Direct
Wattage	50	73	96	120	142	164
Direct lms	4600	6700	8800	11000	13000	15000
Indirect lms						
LPW	91	91	91	91	91	91
Height (B)	6"	6"	7"	13"	17"	21"
# of Sections	1	1	1	1	1	1
Suspension Points	3	3	3	3	3	6
Code	RGTP1P08	RGTP1P09	RGTP1P12	RGTP1P18	RGTP2P02	RGTP2P03
Size (Ft)	8	9	12	18	2	3
Light Distribution	Direct	Direct	Direct	Direct	Direct/Indirect	Direct/Indirect
Wattage	277	307	410	615	68	109
Direct lms	21000	24000	32000	48000	4600	6700
Indirect lms					2200	4400
LPW	78	78	78	78	100	102
Height (B)	30"	35"			6"	6"
# of Sections	3	3	4	6	1	1
Suspension Points	6	6	8	12	3	3
Code	RGTP2P04	RGTP2P05	RGTP2P06	RGTP2P07	RGTP2P08	RGTP2P09
Size (Ft)	4	5	6	7	8	9
Light Distribution	Direct/Indirect	Direct/Indirect	Direct/Indirect	Direct/Indirect	Direct/Indirect	Direct/Indirect
Wattage	132	179	213	259	348	414
Direct lms	8800	11000	13000	15000	21000	24000
Indirect lms	4400	7300	8800	12000	8800	13000
LPW	100	102	102	104	87	89
Height (B)	7"	13"	17"	21"	30"	35"
# of Sections	1	1	1	1	3	3
Suspension Points	3	3	3	6	6	6
Code	RGTP2P12	RGTP2P18				
Size (Ft)	12	18				
Light Distribution	Direct/Indirect	Direct/Indirect				
Wattage	552	864				
Direct lms	32000	48000				
Indirect lms	18000	31000				
LPW	91	91				
Height (B)						
# of Sections	4	6				

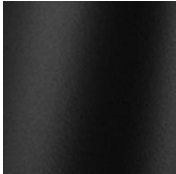

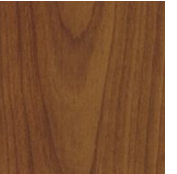
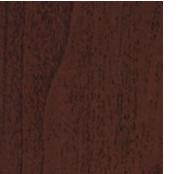
RING 3™ - SUSPENDED

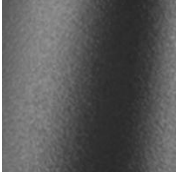





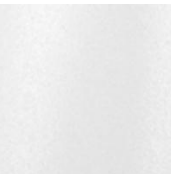

Code	RGTP2P12	RGTP2P18
Suspension Points	8	12

FIXTURE FINISH

							
White	Black Metallic - Textured	Silver Metallic - Textured	Gold Metallic	Wood grain - Light Cherry	Wood grain - Dark Walnut	Midnight Blue Metallic - Textured	Copper Metallic
							
Charcoal Metallic - Textured	Bronze Metallic - Textured	Champagne Metallic	Red Metallic - Textured				

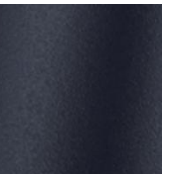
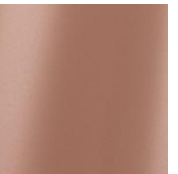
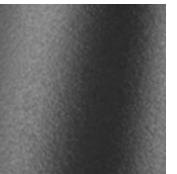
* Longer than normal lead times may apply, consult factory.

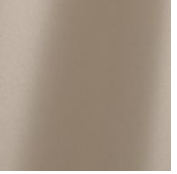
CANOPY FINISH

							
White	Black Metallic - Textured	Silver Metallic - Textured	Gold Metallic	Midnight Blue Metallic - Textured	Copper Metallic	Charcoal Metallic - Textured	Bronze Metallic - Textured
							
Champagne Metallic	Red Metallic - Textured						

RING 3™ - SUSPENDED

ACOUSTIC PANEL COLOR

Not required

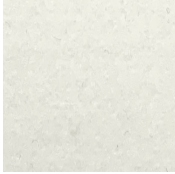

White



Apple Green



Blue



Light Gray

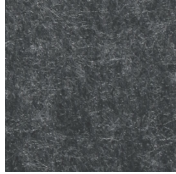

Sesame Gray



Black

Available up to 4ft. Sizes 5ft to 8ft available with visible seams, consult factory. Acoustic panels are not available for sizes of 9ft and larger.

For complimentary non-illuminating acoustic panels see our Acoustic Circles, Quads and Triangles spec pages.

Other colours available to special order. Consult factory.

APPROVALS



RING 3™ - SUSPENDED

DIMENSIONAL DIAGRAMS

Vertical, Integral driver (SS1)

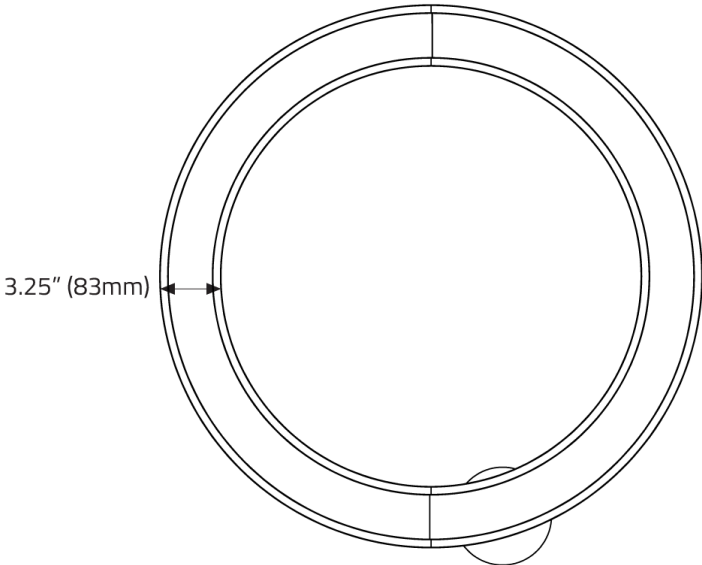
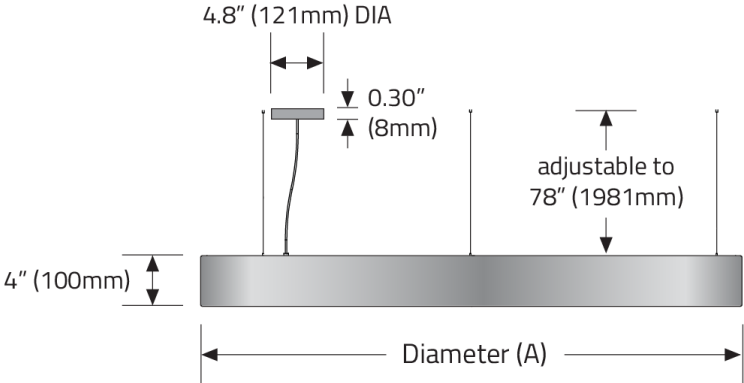

Diameter (A):

RGTP1P02, RGTP2P02	2.2' (676mm)
RGTP1P03, RGTP2P03	3.2' (965mm)
RGTP1P04, RGTP2P04	4.2' (1270mm)
RGTP1P05, RGTP2P05	5.2' (1575mm)
RGTP1P06, RGTP2P06	6.2' (1880mm)
RGTP1P07, RGTP2P07	7.2' (2184mm)
RGTP1P08, RGTP2P08	8.0' (2438mm)
RGTP1P09, RGTP2P09	9.0' (2743mm)
RGTP1P12, RGTP2P12	12.0' (3658mm)
RGTP1P18, RGTP2P18	18.0' (5486mm)

RING 3™ - SUSPENDED

Hub, Integral driver (SS2)

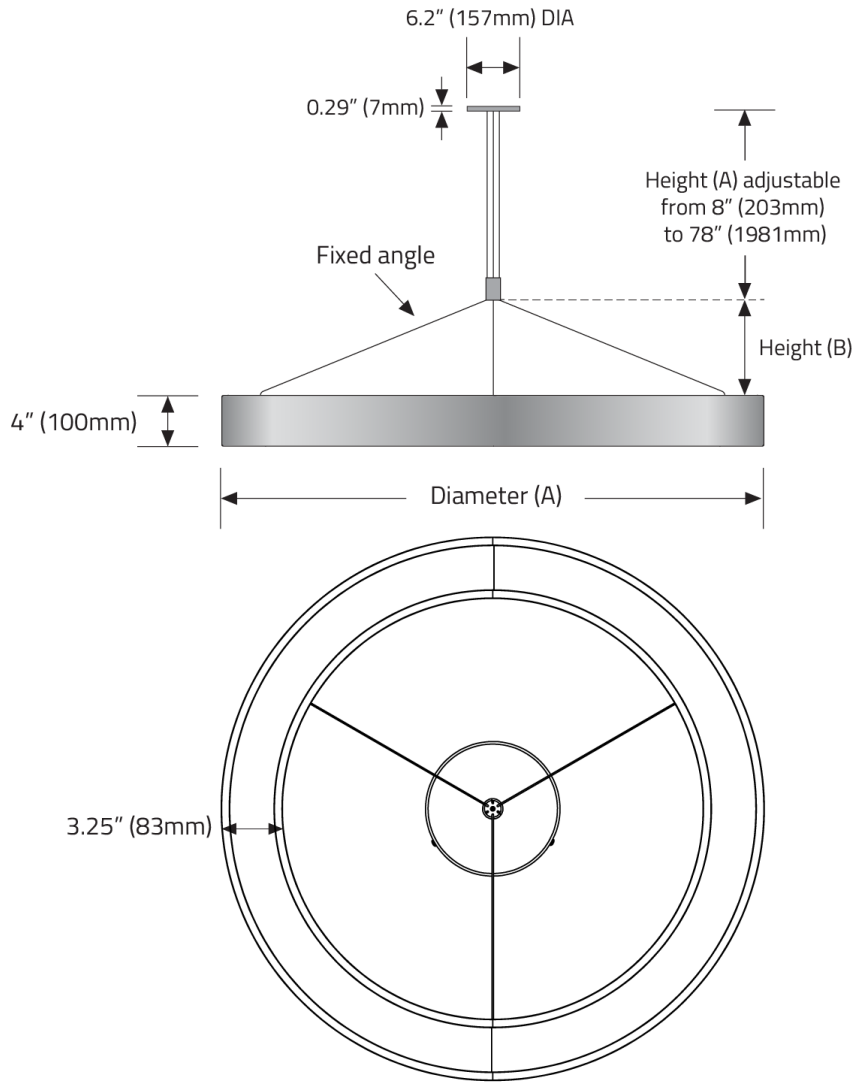

Diameter (A):

RGTP1P02, RGTP2P02	2.2' (676mm)
RGTP1P03, RGTP2P03	3.2' (965mm)
RGTP1P04, RGTP2P04	4.2' (1270mm)
RGTP1P05, RGTP2P05	5.2' (1575mm)
RGTP1P06, RGTP2P06	6.2' (1880mm)
RGTP1P07, RGTP2P07	7.2' (2184mm)
RGTP1P08, RGTP2P08	8.0' (2438mm)
RGTP1P09, RGTP2P09	9.0' (2743mm)
RGTP1P12, RGTP2P12	12.0' (3658mm)
RGTP1P18, RGTP2P18	18.0' (5486mm)

