



PHOS  
ENGINEERING LIGHT

MAXI EYECONIC MINI TRIM ADJUSTABLE  
GENESIS

## MAXI EYECONIC MINI TRIM ADJUSTABLE - GENESIS

The Maxi Eyeconic Mini Trim Adjustable is a recessed, directional downlight with a Ø87mm bezel and features a beautifully sculpted anti-glare baffle. The Maxi Is a high output downlight while still maintaining a surprisingly compact form.

### PRODUCT FEATURES

Downlight

Adjustable

Interior

LED

IP65

Available in all Phos finishes

Interchangeable optics & accessories (pre & post install)

### PHOS STANDARDS

UK designed, manufactured and assembled

5 year warranty

### OPTICS

Standard beam angles:  
15°/ 25°/ 35°/

### PHYSICAL PROPERTIES

Diameter Ø80mm

Height 124mm

Tilt Max 25°

Cut-out Ø87mm

### PRODUCT VIEW



### DIMENSIONS

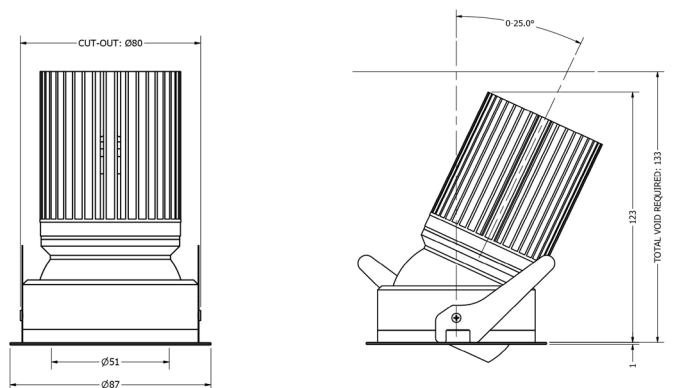

**TECHNICAL SPECIFICATIONS** (Preliminary testing data)

CCT	3000K		
Wattage	13W		
Beam Angles	15°	25°	35°
Luminaire Lumens (lm)	1441	1496	1355
Circuit Watts (c/W)	23.8	23.6	23.8
Luminaire Efficacy (l/cW)	61	63	57
Luminaire (Cd)	16484	6318	3126
Forward Voltage (Vf)	12.65		
Current (mA)	1050		
Binning	2 step MacAdams		
CRI	97+		
TM-30-15	Rg 102 Rf 90		
Lumen Maintenance	LM80		
Lifetime	50,000 hours		
Dimming Options	Mains dim / Non-dim / DALI (dim to dark 0.01%) / Casambi		
Flicker Index	0		
Driver distance from fitting	Up to 10m (AWG 20)*		
Wiring Type	Series		
Accessories	Remote emergency (Maintained / Self Test)		

\*If driver distance from fitting is +10m see driver configurator document for guidance

## LIGHT CONES

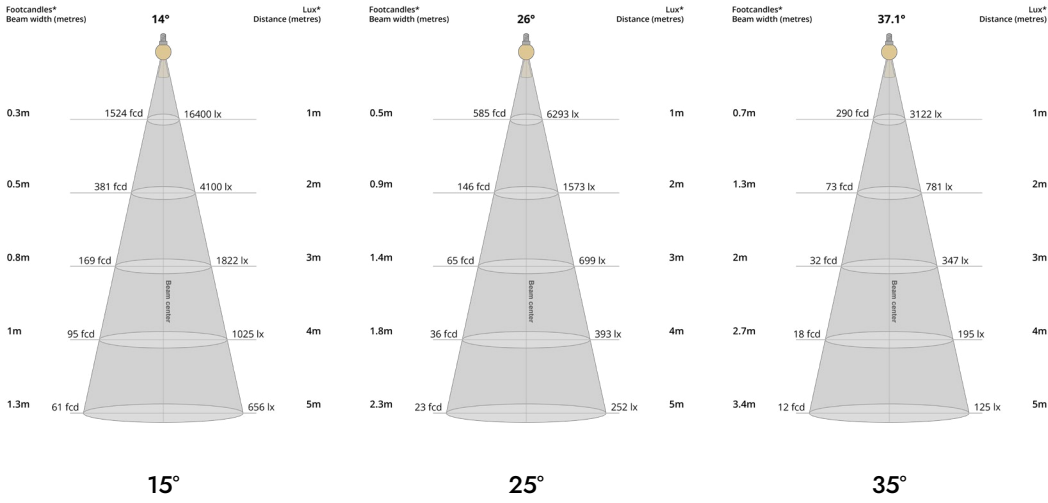

## POLAR CURVES

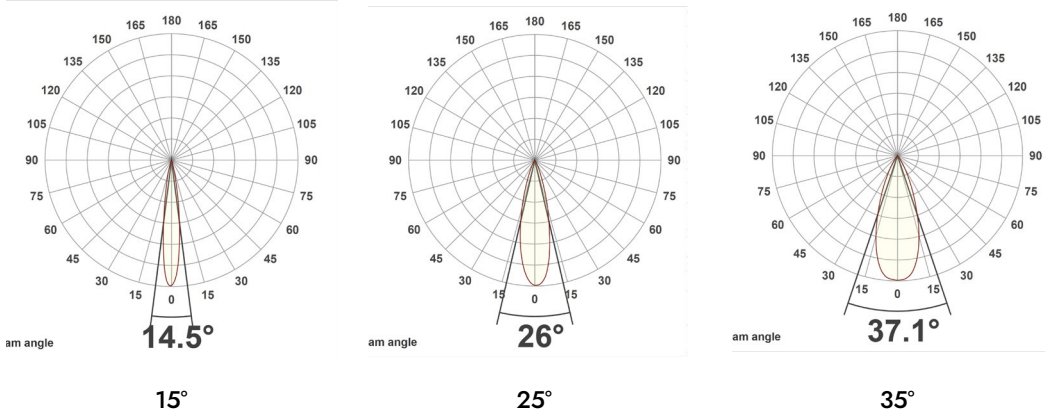

## PARTCODE BUILDER

Example Code: **MX-EY-MTA-WT/B1/WT/WT-GEN13-30-90-25-1050**

Family	Variant	Bezel Finish	Bezel Finish	Outer Baffle Finish	Inner Baffle Finish	Engine	Power	CCT	CRI	Beam Angle	Driver Current
<b>MX</b> Maxi	<b>EY-MTA</b> Eyconic Mini Trim Adjustable	<b>WT</b> White Textured	<b>B1</b> Anodised Black	<b>WT</b> White Textured	<b>WT</b> White Textured	<b>GEN</b> Genesis	<b>13</b> Watts	<b>30</b> 3000K	<b>90</b>	<b>15</b>	<b>1050</b>
		<b>B1</b> Anodised Black		<b>B1</b> Anodised Black	<b>B1</b> Anodised Black					<b>25</b>	
		<b>*C</b> Custom		<b>*C</b> Custom	<b>*C</b> Custom					<b>35</b>	

## FINISHES

Every element of your light can be finished in any of the options below:

### PLATED (Interior ONLY)



Antique Bronze  
01



Antique Brass  
02



Polished Chrome  
03



Satin Nickel  
04



Polished Copper  
05

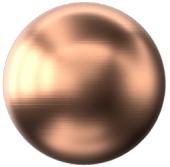

Satin Copper  
06



Polished Brass  
09

### ANODISED (Interior ONLY, except Orba Exteriors)



Tuba Brass  
11

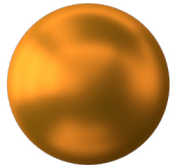

Antique Gold  
12



Espresso Bronze  
13



Cocoa Bronze  
14



Ice Gold  
15



Mocha Bronze  
16



Taupe Bronze  
17

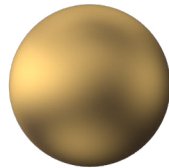

24K Gold  
18

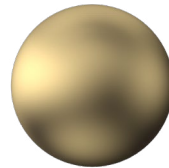

Champagne Gold  
19



Anodised Black (9005)  
B1

### POWDER COAT (Interior & Exterior)



Pure White (9010)  
W1



Textured White (9010)  
WT

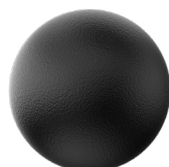

Textured Black (9005)  
BT



RAL Classic  
[www.phos.co.uk/finishes](http://www.phos.co.uk/finishes)



RAL Design  
price on application