



PHOS
ENGINEERING LIGHT

SOFT FIXED
STANDARD

SOFT FIXED - STANDARD

The Soft Fixed is a recessed, fixed downlight with a $\varnothing 54\text{mm}$ beautifully sculpted, trumpet-shaped bezel.

PRODUCT FEATURES

Downlight

Fixed

Interior

LED

IP44

Available in black and white finishes

Interchangeable optics & accessories (pre & post install)

PHOS STANDARDS

60min fire-certified

Acoustic-rated

UK designed, manufactured and assembled

5 year warranty

OPTICS

Standard beam angles:
15°/ 20°/ 25°

PHYSICAL PROPERTIES

Diameter $\varnothing 54\text{mm}$

Height 56mm

Cut-out $\varnothing 41\text{mm}$

DRIVER INFORMATION

[Driver Configurator \(Link\)](#)

PRODUCT VIEW



DIMENSIONS

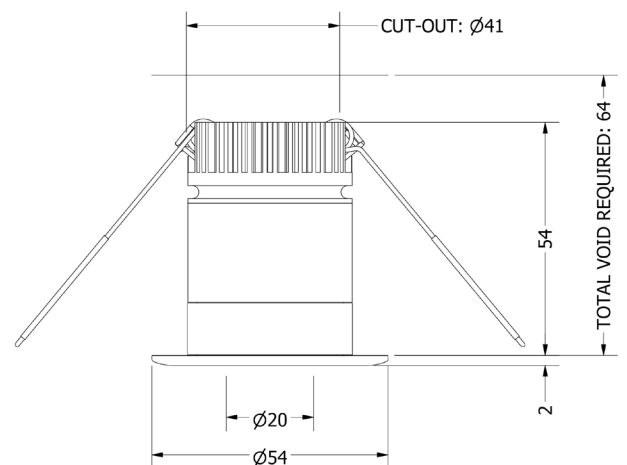

TECHNICAL SPECIFICATIONS

CCT	2700K					
Wattage	1W			3W		
Beam Angles	15°	20°	25°	15°	20°	25°
Luminaire Lumens (lm)	104	98	76	237	230	180
Circuit Watts (c/W)	2.6	2.6	2.6	5.7	5.7	5.7
Luminaire Efficacy (l/cW)	40	37	30	42	40	31
Luminance (Cd)	673	411	205	1640	983	479
Forward Voltage (Vf)	2.78			2.97		
Current (mA)	350			1050		

CCT	3000K					
Wattage	1W			3W		
Beam Angles	15°	20°	25°	15°	20°	25°
Luminaire Lumens (lm)	113	108	89	280	266	215
Circuit Watts (c/W)	2.6	2.6	2.6	5.6	5.6	5.6
Luminaire Efficacy (l/cW)	44	42	34	50	48	39
Luminance (Cd)	836	478	246	2135	1225	625
Forward Voltage (Vf)	2.78			2.97		
Current (mA)	350			1050		

Binning	2 step MacAdams
CRI	90
TM-30-15	Rg 91 Rf 100
Lumen Maintenance	LM80
Lifetime	50,000 hours

Dimming Options	Mains dim / Non-dim / 0-10V / DALI (dim to dark 0.01%) / Casambi
Flicker Index	0
SVM: (Visual Flicker)	0.02

Driver distance from fitting	Up to 10m (AWG 20)*
Wiring Type	Series
Accessories	Remote emergency (Maintained / Self Test)

*If driver distance from fitting is +10m see driver configurator document for guidance

LIGHT CONES

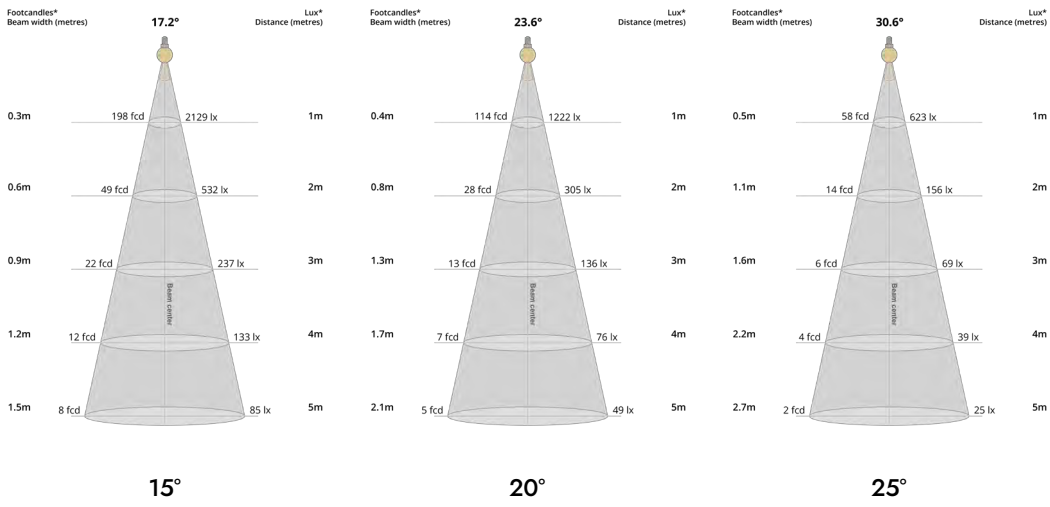

POLAR CURVES

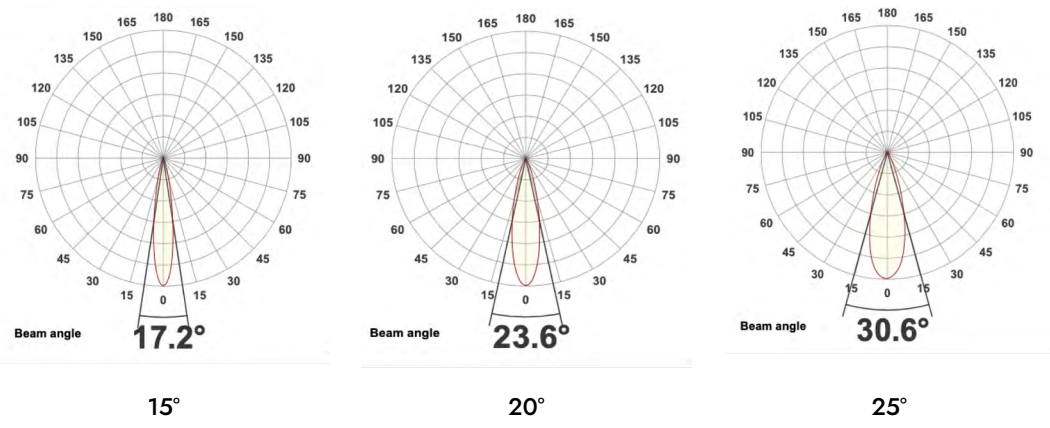

PARTCODE BUILDER

Example Code: S-FX-WT-STD1-27-90-20-350

Family	Variant	Bezel Finish	Engine	Power	CCT	CRI	Beam Angle	Driver Current
S Soft	FX Fixed	WT White Textured	STD Standard	1 Watts	27 2700K	90	15	350
		B1 Anodised Black		3 Watts	30 3000K		20	
		*C Custom					25	1050

*Codes for custom finishes can be found on the next page.

FINISHES

Every element of your light can be finished in any of the options below:

PLATED (Interior ONLY)



Antique Bronze
01



Antique Brass
02



Polished Chrome
03



Satin Nickel
04



Polished Copper
05

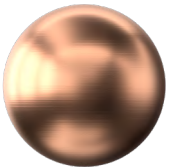

Satin Copper
06



Polished Brass
09

ANODISED (Interior ONLY, except Orba Exteriors)



Tuba Brass
11

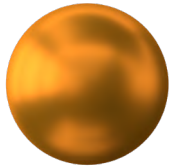

Antique Gold
12



Espresso Bronze
13



Cocoa Bronze
14

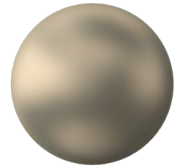

Ice Gold
15



Mocha Bronze
16



Taupe Bronze
17



24K Gold
18

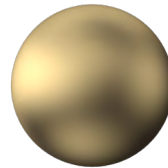

Champagne Gold
19



Anodised Black (9005)
B1

POWDER COAT (Interior & Exterior)



Pure White (9010)
W1



Textured White (9010)
WT

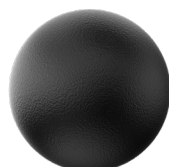

Textured Black (9005)
BT



RAL Classic
www.phos.co.uk/finishes



RAL Design
price on application