

PHOS
ENGINEERING LIGHT

PANO MINI
STANDARD

PANO MINI - STANDARD

The Pano Mini is a recessed, fixed ground or wall light with a $\varnothing 44\text{mm}$ minimalist bezel.

PRODUCT FEATURES

Uplight / Wall Light

Fixed

Interior / Exterior

LED

IP67

Available in all Phos finishes

Interchangeable optics & accessories (pre & post install)

PHOS STANDARDS

60min fire-certified

Acoustic-rated

UK designed, manufactured and assembled

5 year warranty

OPTICS

Standard beam angles:
15° / 20° / 30°

PHYSICAL PROPERTIES

Diameter $\varnothing 44\text{mm}$

Height 44mm

Cut-out $\varnothing 38\text{mm}$

DRIVER INFORMATION

[Driver Configurator \(Link\)](#)

PRODUCT VIEW



DIMENSIONS

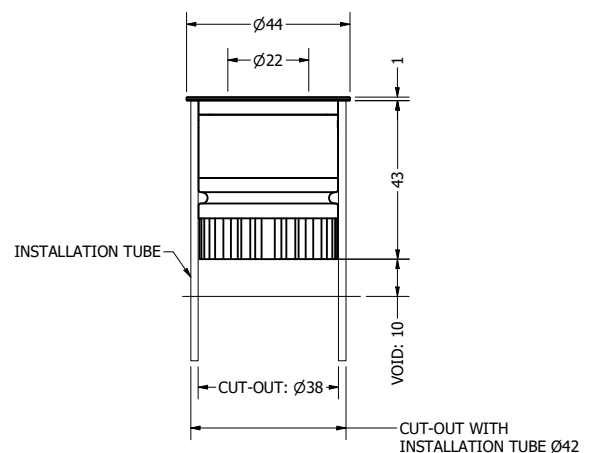

TECHNICAL SPECIFICATIONS

CCT	2700K					
Wattage	1W			3W		
Beam Angles	15°	20°	30°	15°	20°	30°
Luminaire Lumens (lm)	99	98	82	242	240	196
Circuit Watts (c/W)	2.6	2.7	2.6	5.6	5.6	5.6
Luminaire Efficacy (l/cW)	38	37	31	43	43	35
Luminance (Cd)	736	424	203	1775	1045	488
Forward Voltage (Vf)	2.78			2.97		
Current (mA)	350			1050		

CCT	3000K					
Wattage	1W			3W		
Beam Angles	10°	20°	30°	10°	20°	30°
Luminaire Lumens (lm)	114	114	94	287	279	230
Circuit Watts (c/W)	2.6	2.6	2.6	5.6	5.6	5.5
Luminaire Efficacy (l/cW)	44	44	36	52	50	42
Luminance (Cd)	896	500	244	2314	1285	607
Forward Voltage (Vf)	2.78			2.97		
Current (mA)	350			1050		

Binning	2 step MacAdams
CRI	90+
TM-30-15	Rg 96.87 Rf 91.58
Lumen Maintenance	LM80
Lifetime	50,000 hours

Dimming Options	Mains dim / Non-dim / 0-10V / DALI (dim to dark 0.01%) / Casambi
Flicker Index	0
SVM: (Visual Flicker)	0.02

Driver distance from fitting	Up to 10m (AWG 20)*
Wiring Type	Series
Accessories	Remote emergency (Maintained / Self Test)

*If driver distance from fitting is +10m see driver configurator document for guidance

LIGHT CONES

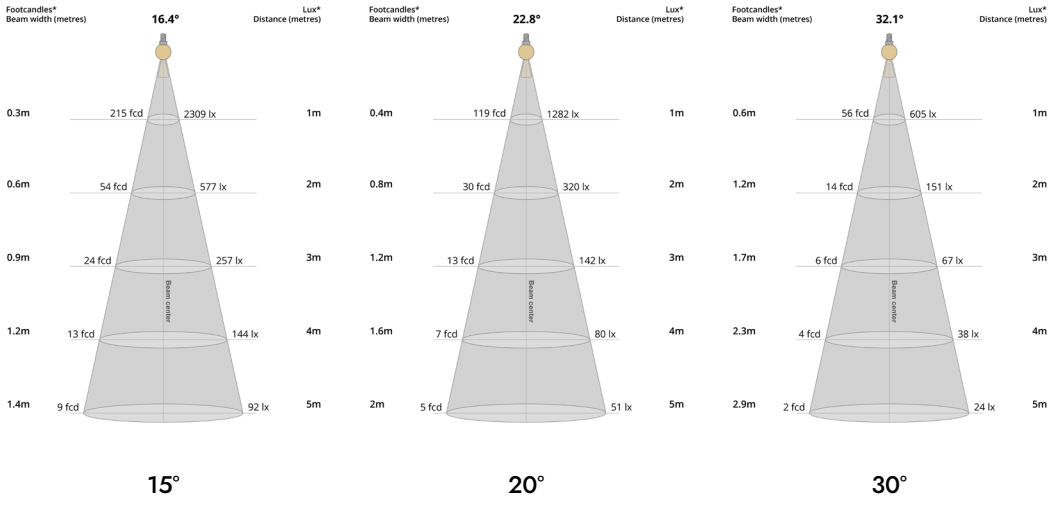

POLAR CURVES

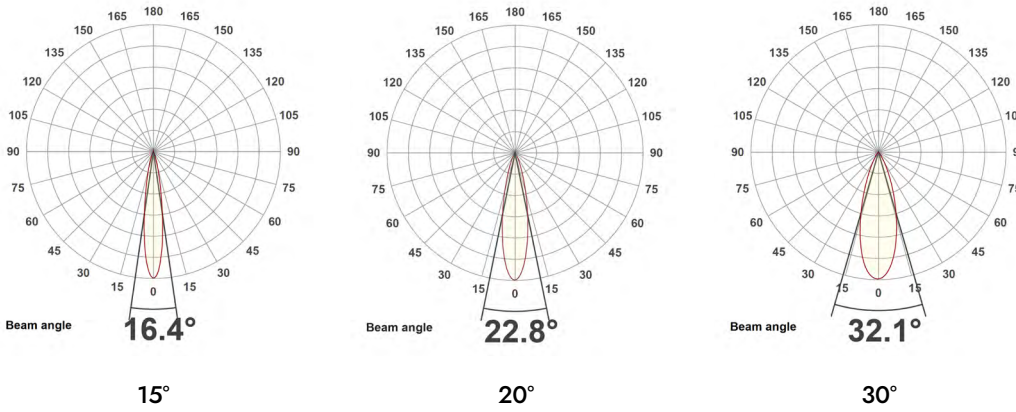

PARTCODE BUILDER

Example Code: MI-P-WT-STD3-30-90-20-1050

Variant	Family	Bezel Finish	Engine	Power	CCT	CRI	Beam Angle	Driver Current
MI Mini	P Pano	WT White Textured	STD Standard	1 Watts	27 2700K	90	15	350
		B1 Anodised Black			30 3000K		20	
		*C Custom		3 Watts			30	1050

*Codes for custom finishes can be found on the page 6.

ACCESSORIES



Pano Mini Installation Tube
ACC-P4-TUBE

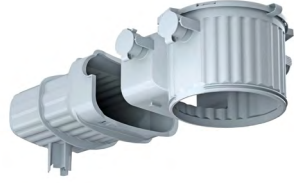

Pano Install Concrete Box
ACC-HALOX100-190+FRONT

FINISHES

Every element of your light can be finished in any of the options below:

PLATED (Interior ONLY)



Antique Bronze
01



Antique Brass
02



Polished Chrome
03



Satin Nickel
04



Polished Copper
05

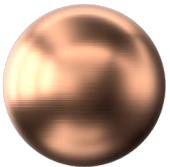

Satin Copper
06



Polished Brass
09

ANODISED (Interior ONLY, except Orba Exteriors)



Tuba Brass
11



Antique Gold
12



Espresso Bronze
13



Cocoa Bronze
14

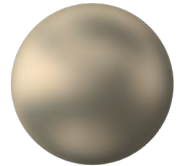

Ice Gold
15



Mocha Bronze
16



Taupe Bronze
17



24K Gold
18

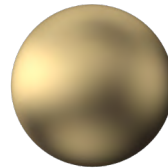

Champagne Gold
19



Anodised Black (9005)
B1

POWDER COAT (Interior & Exterior)



Pure White (9010)
W1



Textured White (9010)
WT

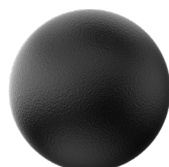

Textured Black (9005)
BT



RAL Classic
www.phos.co.uk/finishes



RAL Design
price on application