

PHOS
ENGINEERING LIGHT

NANO PANO DARKLIGHT SPRING
STANDARD

NANO PANO DARKLIGHT SPRING - STANDARD

The Nano Pano Darklight Spring is an incredibly discreet recessed fixed light with multiple install applications including; ceiling in-ground and wall light. Featuring a $\varnothing 36\text{mm}$ minimalist bezel.

PRODUCT FEATURES

Multiple install Applications

Fixed

Interior / Exterior

LED

IP67

Available in all Phos finishes

Interchangeable optics & accessories (pre & post install)

PHOS STANDARDS

UK designed, manufactured and assembled

5 year warranty

OPTICS

Standard beam angles:
20° / 30° / 40° / 55°

PHYSICAL PROPERTIES

Diameter $\varnothing 36\text{mm}$

Height 49mm

Cut-out $\varnothing 30\text{mm}$

PRODUCT VIEW



DIMENSIONS

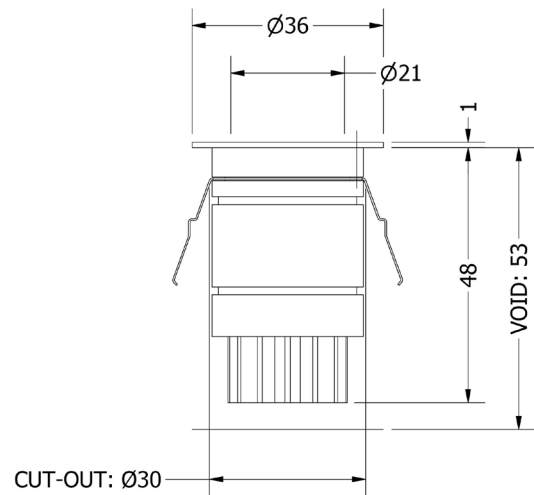

TECHNICAL SPECIFICATIONS (Preliminary testing data)

CCT	2700K							
Wattage	1W				3W			
Beam Angles	20°	30°	40°	55°	20°	30°	40°	55°
Luminaire Lumens (lm)	103	107	77.2	83	243	249	192	208
Circuit Watts (c/W)	2.6	2.7	2.6	2.6	5.7	5.8	5.8	5.7
Luminaire Efficacy (l/cW)	39	40	30	32	43	43	33	37
Luminance (Cd)	577	292	126	92.5	1395	717	316	232
Forward Voltage (Vf)	2.78				2.97			
Current (mA)	350				1050			

CCT	3000K							
Wattage	1W				3W			
Beam Angles	20°	30°	40°	55°	20°	30°	40°	55°
Luminaire Lumens (lm)	113	115	86.2	89.8	263	273	209	222
Circuit Watts (c/W)	2.7	2.6	2.6	2.6	5.7	5.7	5.7	5.8
Luminaire Efficacy (l/cW)	42	43	33	34	46	48	37	39
Luminance (Cd)	593	307	138	102	1443	795	342	252
Forward Voltage (Vf)	2.78				2.97			
Current (mA)	350				1050			

Binning	2 step MacAdams
CRI	90+
TM-30-15	Rg 96.87 Rf 91.58
Lumen Maintenance	LM80
Lifetime	50,000 hours

Dimming Options	Mains dim / Non-dim / 0-10V / DALI (dim to dark 0.01%) / Casambi
Flicker Index	0
SVM: (Visual Flicker)	0.02

Driver distance from fitting	Up to 10m (AWG 20)*
Wiring Type	Series
Accessories	Remote emergency (Maintained / Self Test)

*If driver distance from fitting is +10m see driver configurator document for guidance

LIGHT CONES

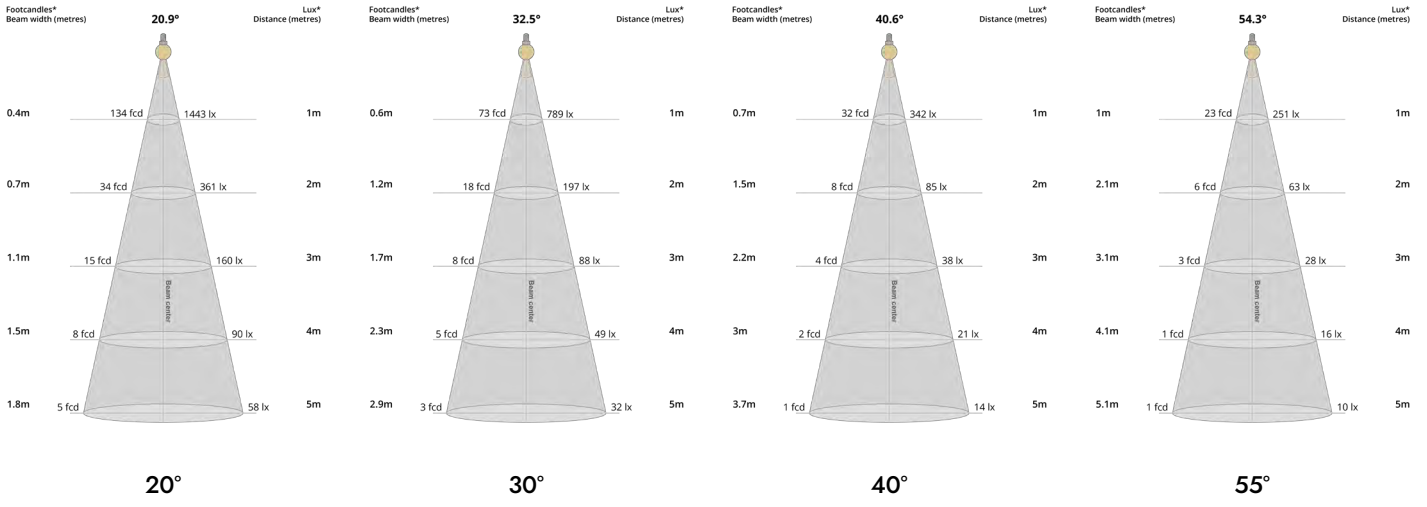

POLAR CURVES

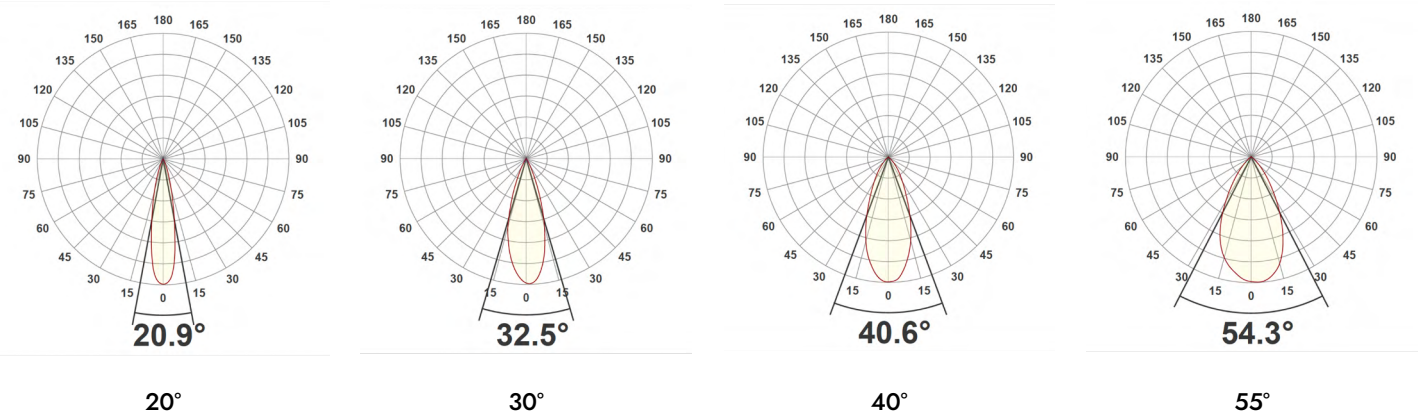

PARTCODE BUILDER

Example Code: NA-PD-S-WT-STD1-30-90-20-350

Family	Variant	Bezel Finish	Engine	Power	CCT	CRI	Beam Angle	Driver Current
NA Nano	PD-S Pano Darklight Spring	WT White Textured	STD Standard	1 Watts	27 2700K	90	20	350
		B1 Anodised Black			30 3000K		30	
		*C Custom		3 Watts			40	1050
							55	

*Codes for custom finishes can be found on the page 6.

ACCESSORIES (multiple inserts available per fitting)



Commissioning Tool (Plastic)
ACCS-TOOL-P-BAFFLE



SNOOT
ACCS-SNOOT



Honeycomb Recessed
ACCS-RECESSED-HCOMB



Honeycomb Flush
ACCS-FLUSH-HCOMB



Softening Insert Recessed
ACCS-RECESSED-SOFT



Softening Insert Flush
ACCS-FLUSH-SOFT



Opal Insert Recessed
ACCS-RECESSED-OPAL



Opal Insert Flush
ACCS-FLUSH-OPAL



Elliptical Insert Recessed
ACCS-RECESSED-10X60ELLIPTICAL



Elliptical Insert Flush
ACCS-FLUSH-10X60ELLIPTICAL



Colour Change Insert Recessed
ACCS-RECESSED-FILTER18K
ACCS-RECESSED-FILTER22K
ACCS-RECESSED-FILTER24K
ACCS-RECESSED-FILTER25K



Colour Change Insert Flush
ACCS-FLUSH-FILTER18K
ACCS-FLUSH-FILTER22K
ACCS-FLUSH-FILTER24K
ACCS-FLUSH-FILTER25K

FINISHES

Every element of your light can be finished in any of the options below:

PLATED (Interior ONLY)



Antique Bronze
01



Antique Brass
02



Polished Chrome
03



Satin Nickel
04



Polished Copper
05

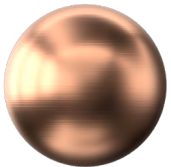

Satin Copper
06



Polished Brass
09

ANODISED (Interior ONLY, except Orba Exteriors)

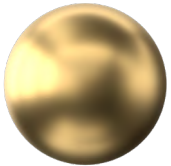

Tuba Brass
11

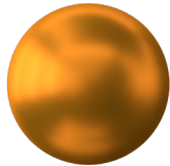

Antique Gold
12



Espresso Bronze
13



Cocoa Bronze
14

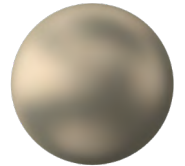

Ice Gold
15



Mocha Bronze
16



Taupe Bronze
17



24K Gold
18

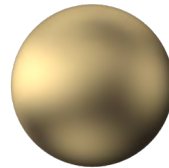

Champagne Gold
19



Anodised Black (9005)
B1

POWDER COAT (Interior & Exterior)



Pure White (9010)
W1



Textured White (9010)
WT

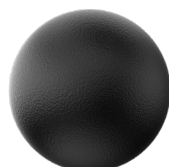

Textured Black (9005)
BT



RAL Classic
www.phos.co.uk/finishes



RAL Design
price on application