



PHOS  
ENGINEERING LIGHT

OCCULAR SQUARE MINI TRIM PLUG & PLAY  
STANDARD

## OCCULAR SQUARE MINI TRIM PLUG & PLAY- STANDARD

Featuring the  $\varnothing 62$ mm Mini Trim bezel from our Eyeconic range and an ingenious plug & play connector to provide a high degree of modularity between ranges.

### PRODUCT FEATURES

Spotlight

Adjustable

Interior

LED

IP54

Available in all Phos finishes

Interchangeable optics (pre & post install)

### PHOS STANDARDS

60min fire-certified

Acoustic-rated

UK designed, manufactured and assembled

5 year warranty

### OPTICS

Standard beam angles:  
10° / 20° / 30° / 50°

Ellipsoidal accessories using:

10° optic: 14.8° x 53.2°

20° optic: 24.1° x 58.8°

30° optic: 37.5° x 66.3°

50° optic: 45.8° x 72.6°

### PHYSICAL PROPERTIES

Diameter  $\varnothing 62$ mm

Height 125mm

Cut-out  $\varnothing 56$ mm

Tilt Max 90°

Rotation 360°

### DRIVER INFORMATION

[Driver Configurator \(Link\)](#)

### PRODUCT VIEW



### DIMENSIONS

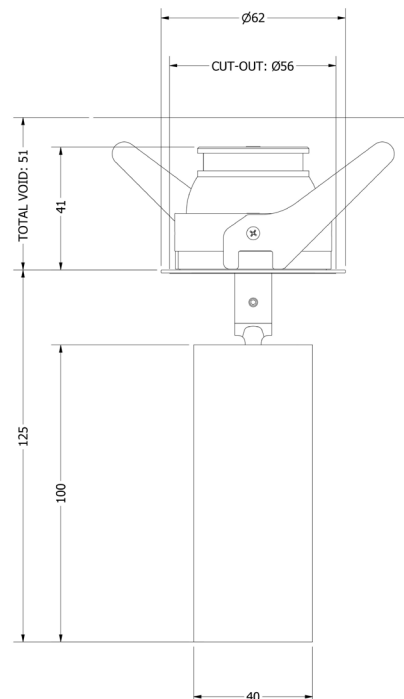

## TECHNICAL SPECIFICATIONS

CCT	2700K											
Wattage	4W				9W				14W			
Beam Angles	10°	20°	30°	50°	10°	20°	30°	50°	10°	20°	30°	50°
Luminaire Lumens (lm)	338	307	301	315	593	513	504	518	756	654	646	665
Circuit Watts (c/W)	5.9	6	5.9	6	10.5	10.5	10.6	10.6	15.6	15.6	15.6	15.6
Luminaire Efficacy (l/cW)	57	51	51	53	56	49	48	49	48	42	41	43
Luminaire (Cd)	6435	1665	1008	402	11015	2790	1627	672	14339	3595	2065	857
Forward Voltage (Vf)	11.78				12.36				12.85			
Current (mA)	350				700				1050			

CCT	3000K											
Wattage	4W				9W				14W			
Beam Angles	10°	20°	30°	50°	10°	20°	30°	50°	10°	20°	30°	50°
Luminaire Lumens (lm)	393	341	331	345	681	583	580	591	881	769	752	789
Circuit Watts (c/W)	5.9	5.9	5.9	5.9	10.6	10.5	10.5	10.5	15.8	15.8	15.8	15.8
Luminaire Efficacy (l/cW)	67	58	56	58	64	55	55	56	56	49	47	50
Luminaire (Cd)	6150	1709	1072	444	10607	2932	1722	771	13743	3861	2298	1022
Forward Voltage (Vf)	11.78				12.36				12.85			
Current (mA)	350				700				1050			

Binning	2 step MacAdams											
CRI	90+											
TM-30-15	Rg 102 Rf 90											
Lumen Maintenance	LM80											
Lifetime	50,000 hours											
Dimming Options	Mains dim / Non-dim / 0-10V / DALI (dim to dark 0.01%) / Casambi											
Flicker Index	0											
SVM: (Visual Flicker)	0.02											
Driver distance from fitting	Up to 10m (AWG 20)*											
Wiring Type	Series											
Accessories	Remote emergency (Maintained / Self Test)											

\*If driver distance from fitting is +10m see driver configurator document for guidance

## LIGHT CONES

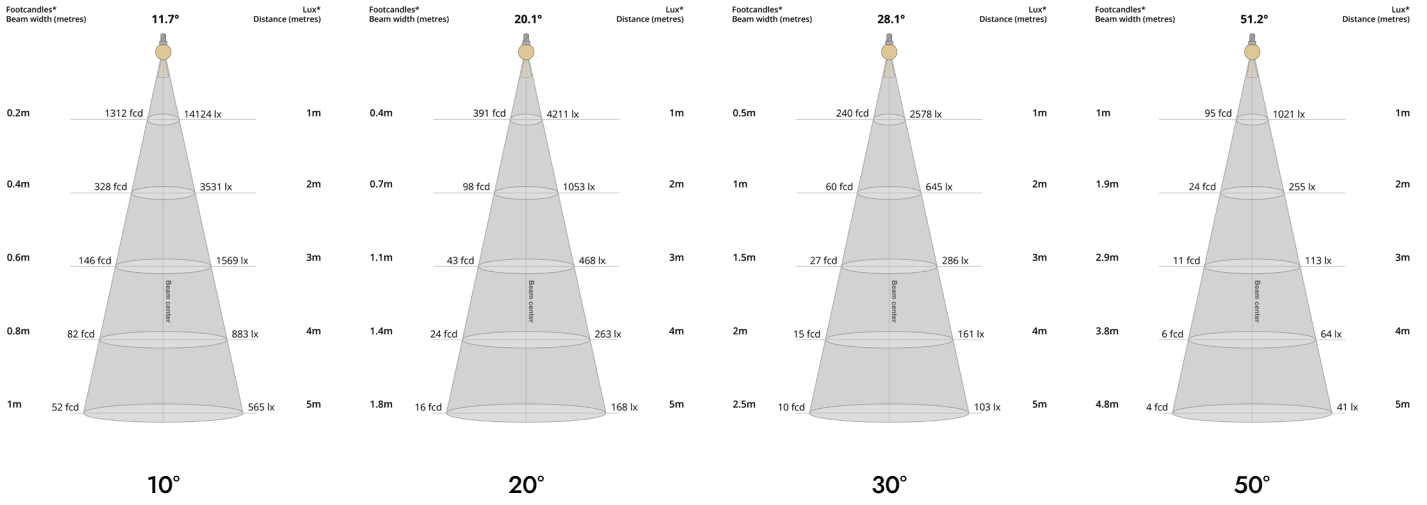

## POLAR CURVES

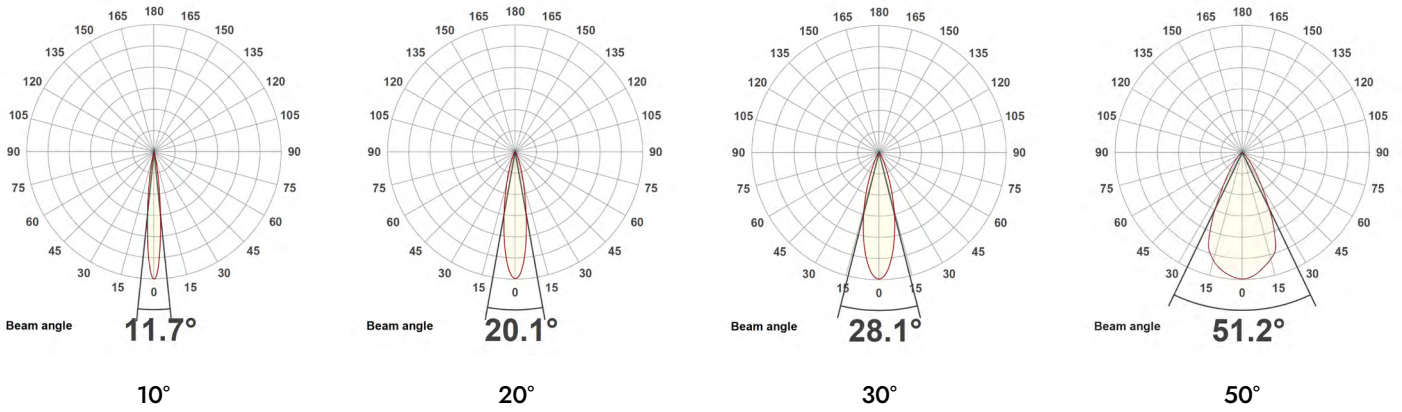

## LUMINAIRE PARTCODE BUILDER

Example Code: **OC-S-MTPP-WT/WT/WT/WT-STD4-27-90-20-350**

Family	Variant	Mount Finish	Arm Finish	Body Finish	Inner Baffle Finish	Engine	Power	CCT	CRI	Beam Angle	Driver Current
<b>OC-S</b> Ocular Square	<b>MTPP</b> Mini Trim Plug & Play	<b>WT</b> White Textured	<b>WT</b> White Textured	<b>WT</b> White Textured	<b>WT</b> White Textured	<b>STD</b> Standard	<b>4</b> Watts	<b>27</b> 2700K	<b>90</b>	<b>10</b>	<b>350</b>
		<b>B1</b> Anodised Black	<b>B1</b> Anodised Black	<b>B1</b> Anodised Black	<b>B1</b> Anodised Black		<b>9</b> Watts	<b>30</b> 3000K		<b>20</b>	<b>700</b>
		<b>*C</b> Custom	<b>*C</b> Custom	<b>*C</b> Custom	<b>*C</b> Custom		<b>14</b> Watts	<b>40</b> 4000K		<b>30</b>	<b>1050</b>
										<b>50</b>	

## FRAME PARTCODE BUILDER

Example Code: **FR-MT-WT/WT**

Variant	Bezel Finish	Socket Finish
<b>FR-MT</b> Mini Trim Frame	<b>WT</b> Textured White  <b>B1</b> Anodised Black  <b>*C</b> Custom	<b>WT</b> Textured White  <b>B1</b> Anodised Black  <b>*C</b> Custom

\*Codes for custom finishes can be found on the page 7.

**ACCESSORIES** (multiple inserts available per fitting)



Commissioning Tool (Plastic)  
ACCS-TOOL-P-BAFFLE



SNOOT  
ACCS-SNOOT



Honeycomb Recessed  
ACCS-RECESSED-HCOMB



Honeycomb Flush  
ACCS-FLUSH-HCOMB



Softening Insert Recessed  
ACCS-RECESSED-SOFT



Softening Insert Flush  
ACCS-FLUSH-SOFT



Opal Insert Recessed  
ACCS-RECESSED-OPAL



Opal Insert Flush  
ACCS-FLUSH-OPAL



Elliptical Insert Recessed  
ACCS-RECESSED-10X60ELLIPTICAL



Elliptical Insert Flush  
ACCS-FLUSH-10X60ELLIPTICAL



Colour Change Insert Recessed  
ACCS-RECESSED-FILTER18K  
ACCS-RECESSED-FILTER22K  
ACCS-RECESSED-FILTER24K  
ACCS-RECESSED-FILTER25K



Colour Change Insert Flush  
ACCS-FLUSH-FILTER18K  
ACCS-FLUSH-FILTER22K  
ACCS-FLUSH-FILTER24K  
ACCS-FLUSH-FILTER25K

## FINISHES

Every element of your light can be finished in any of the options below:

### PLATED (Interior ONLY)



Antique Bronze  
01



Antique Brass  
02



Polished Chrome  
03



Satin Nickel  
04



Polished Copper  
05

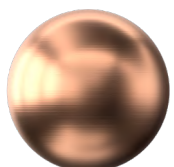

Satin Copper  
06



Polished Brass  
09

### ANODISED (Interior ONLY, except Orba Exteriors)

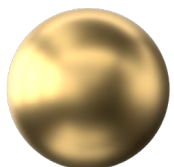

Tuba Brass  
11

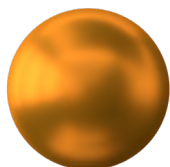

Antique Gold  
12



Espresso Bronze  
13



Cocoa Bronze  
14

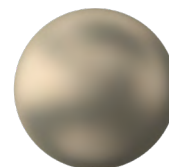

Ice Gold  
15



Mocha Bronze  
16



Taupe Bronze  
17



24K Gold  
18

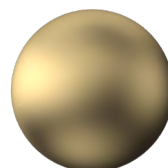

Champagne Gold  
19



Anodised Black (9005)  
B1

### POWDER COAT (Interior & Exterior)



Pure White (9010)  
W1



Textured White (9010)  
WT

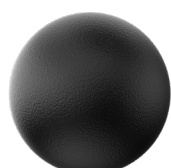

Textured Black (9005)  
BT



RAL Classic  
[www.phos.co.uk/finishes](http://www.phos.co.uk/finishes)



RAL Design  
price on application