



PHOS
ENGINEERING LIGHT

OCCULAR SQUARE MINI TRIM
STANDARD

OCCULAR SQUARE MINI TRIM - STANDARD

Featuring the $\varnothing 62$ mm Mini Trim bezel from our Eyeconic range to provide a high degree of modularity between ranges.

PRODUCT FEATURES

Spotlight

Adjustable

Interior

LED

IP54

Available in all Phos finishes

Interchangeable optics (pre & post install)

PHOS STANDARDS

60min fire-certified

Acoustic-rated

UK designed, manufactured and assembled

5 year warranty

OPTICS

Standard beam angles:
10° / 20° / 30° / 50°

Ellipsoidal accessories using:

10° optic: 14.8° x 53.2°

20° optic: 24.1° x 58.8°

30° optic: 37.5° x 66.3°

50° optic: 45.8° x 72.6°

PHYSICAL PROPERTIES

Diameter $\varnothing 62$ mm

Height 112mm

Cut-out $\varnothing 56$ mm

Tilt Max 90°

Rotation 360°

DRIVER INFORMATION

[Driver Configurator \(Link\)](#)

PRODUCT VIEW



DIMENSIONS

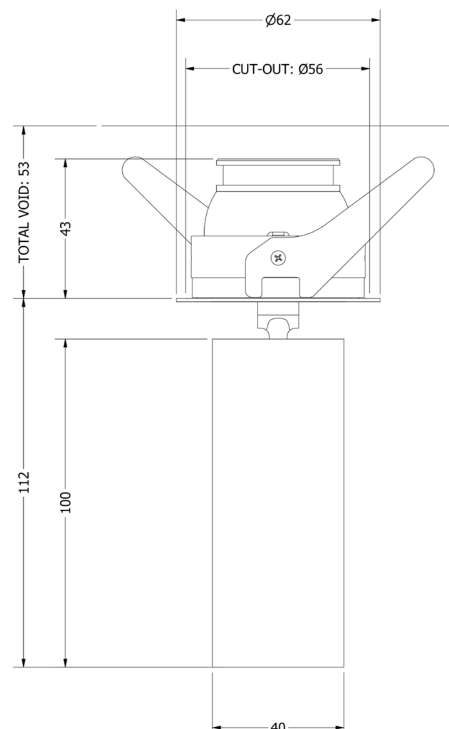

TECHNICAL SPECIFICATIONS

CCT	2700K											
Wattage	4W				9W				14W			
Beam Angles	10°	20°	30°	50°	10°	20°	30°	50°	10°	20°	30°	50°
Luminaire Lumens (lm)	338	307	301	315	593	513	504	518	756	654	646	665
Circuit Watts (c/W)	5.9	6	5.9	6	10.5	10.5	10.6	10.6	15.6	15.6	15.6	15.6
Luminaire Efficacy (l/cW)	57	51	51	53	56	49	48	49	48	42	41	43
Luminance (Cd)	6435	1665	1008	402	11015	2790	1627	672	14339	3595	2065	857
Forward Voltage (Vf)	11.78				12.36				12.85			
Current (mA)	350				700				1050			

CCT	3000K											
Wattage	4W				9W				14W			
Beam Angles	10°	20°	30°	50°	10°	20°	30°	50°	10°	20°	30°	50°
Luminaire Lumens (lm)	393	341	331	345	681	583	580	591	881	769	752	789
Circuit Watts (c/W)	5.9	5.9	5.9	5.9	10.6	10.5	10.5	10.5	15.8	15.8	15.8	15.8
Luminaire Efficacy (l/cW)	67	58	56	58	64	55	55	56	56	49	47	50
Luminance (Cd)	6150	1709	1072	444	10607	2932	1722	771	13743	3861	2298	1022
Forward Voltage (Vf)	11.78				12.36				12.85			
Current (mA)	350				700				1050			

Binning	2 step MacAdams											
CRI	90+											
TM-30-15	Rg 102 Rf 90											
Lumen Maintenance	LM80											
Lifetime	50,000 hours											
Dimming Options	Mains dim / Non-dim / 0-10V / DALI (dim to dark 0.01%) / Casambi											
Flicker Index	0											
SVM: (Visual Flicker)	0.02											
Driver distance from fitting	Up to 10m (AWG 20)*											
Wiring Type	Series											
Accessories	Remote emergency (Maintained / Self Test)											

*If driver distance from fitting is +10m see driver configurator document for guidance

LIGHT CONES

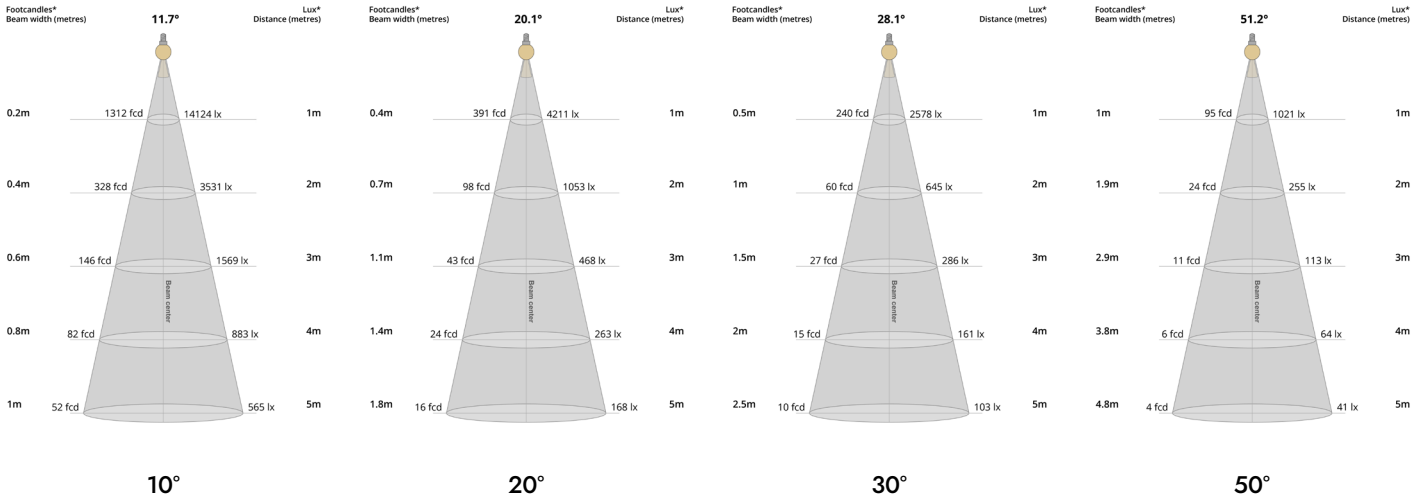

POLAR CURVES

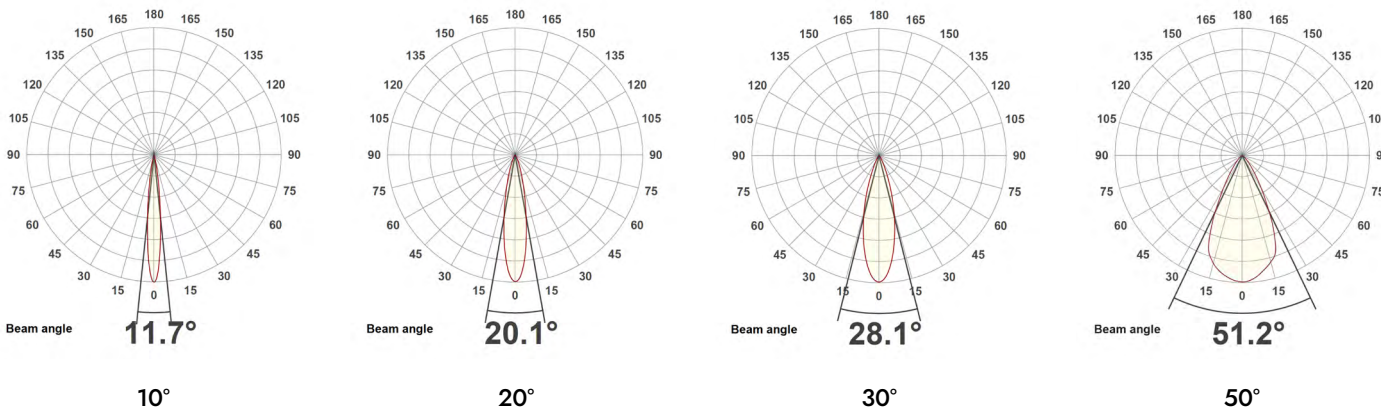

PARTCODE BUILDER

Example Code: **OC-S-MT-WT/WT/WT/WT/WT/WT-WT-STD14-30-90-20-1050**

Family	Variant	Mount Finish	Arm Finish	Bezel Finish	Socket Finish	Body Finish	Inner Baffle Finish	Engine	Power	CCT	CRI	Beam Angle	Driver Current
OC-S Ocular Square	MT Micro Trim	WT White Textured B1 Anodised Black *C Custom	WT White Textured B1 Anodised Black *C Custom	WT White Textured B1 Anodised Black *C Custom	WT White Textured B1 Anodised Black *C Custom	WT White Textured B1 Anodised Black *C Custom	WT White Textured B1 Anodised Black *C Custom	STD Standard	4 Watts	27 2700K	90	10	350
									9 Watts	30 3000K		20	700
									14 Watts	40 4000K		30	1050

*Codes for custom finishes can be found on the page 6.

ACCESSORIES (multiple inserts available per fitting)



Commissioning Tool (Plastic)
ACCS-TOOL-P-BAFFLE



SNOOT
ACCS-SNOOT



Honeycomb Recessed
ACCS-RECESSED-HCOMB



Honeycomb Flush
ACCS-FLUSH-HCOMB



Softening Insert Recessed
ACCS-RECESSED-SOFT



Softening Insert Flush
ACCS-FLUSH-SOFT



Opal Insert Recessed
ACCS-RECESSED-OPAL



Opal Insert Flush
ACCS-FLUSH-OPAL



Elliptical Insert Recessed
ACCS-RECESSED-10X60ELLIPTICAL



Elliptical Insert Flush
ACCS-FLUSH-10X60ELLIPTICAL



Colour Change Insert Recessed
ACCS-RECESSED-FILTER18K
ACCS-RECESSED-FILTER22K
ACCS-RECESSED-FILTER24K
ACCS-RECESSED-FILTER25K



Colour Change Insert Flush
ACCS-FLUSH-FILTER18K
ACCS-FLUSH-FILTER22K
ACCS-FLUSH-FILTER24K
ACCS-FLUSH-FILTER25K

FINISHES

Every element of your light can be finished in any of the options below:

PLATED (Interior ONLY)



Antique Bronze
01



Antique Brass
02



Polished Chrome
03



Satin Nickel
04



Polished Copper
05

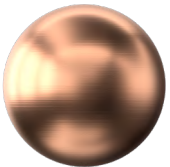

Satin Copper
06



Polished Brass
09

ANODISED (Interior ONLY, except Orba Exteriors)



Tuba Brass
11

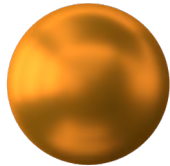

Antique Gold
12



Espresso Bronze
13



Cocoa Bronze
14

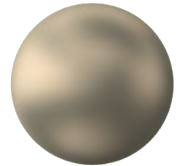

Ice Gold
15



Mocha Bronze
16



Taupe Bronze
17



24K Gold
18

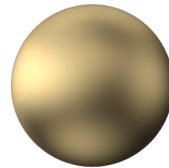

Champagne Gold
19



Anodised Black (9005)
B1

POWDER COAT (Interior & Exterior)



Pure White (9010)
W1



Textured White (9010)
WT

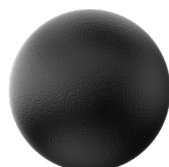

Textured Black (9005)
BT



RAL Classic
www.phos.co.uk/finishes



RAL Design
price on application