



PHOS  
ENGINEERING LIGHT

OCCULAR ROUND MINI TRIM  
STANDARD

## OCCULAR ROUND MINI TRIM - STANDARD

Featuring the  $\varnothing 62$ mm Mini Trim bezel from our Eyeconic range to provide a high degree of modularity between ranges.

### PRODUCT FEATURES

Spotlight

Adjustable

Interior

LED

IP54

Available in all Phos finishes

Interchangeable optics (pre & post install)

### PHOS STANDARDS

60min fire-certified

Acoustic-rated

UK designed, manufactured and assembled

5 year warranty

### OPTICS

Standard beam angles:

10° / 20° / 30° / 50°

Ellipsoidal accessories using:

10° optic: 14.8° x 53.2°

20° optic: 24.1° x 58.8°

30° optic: 37.5° x 66.3°

50° optic: 45.8° x 72.6°

### PHYSICAL PROPERTIES

Diameter  $\varnothing 62$ mm

Height 112mm

Cut-out  $\varnothing 56$ mm

Tilt Max 90°

Rotation 360°

### DRIVER INFORMATION

[Driver Configurator \(Link\)](#)

### PRODUCT VIEW



### DIMENSIONS

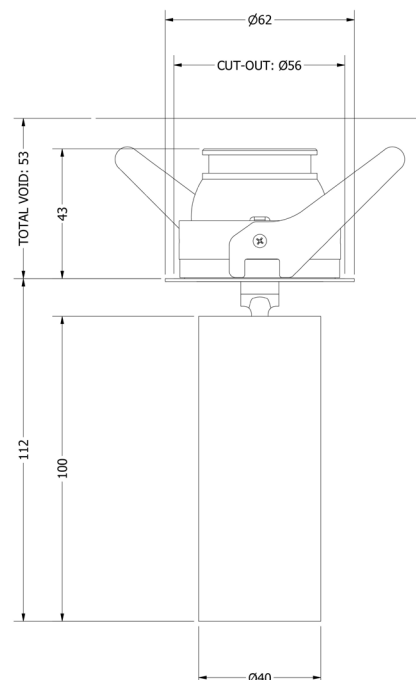

## TECHNICAL SPECIFICATIONS

CCT	2700K											
Wattage	4W				9W				14W			
Beam Angles	10°	20°	30°	50°	10°	20°	30°	50°	10°	20°	30°	50°
Luminaire Lumens (lm)	343	301	295	308	585	499	497	510	747	637	631	658
Circuit Watts (c/W)	6	6	6	6	10.6	10.5	10.6	10.5	15.6	15.5	15.5	15.5
Luminaire Efficacy (l/cW)	57	51	49	52	55	47	47	49	48	41	41	42
Luminance (Cd)	6258	1507	862	385	10645	2546	1433	672	14809	3571	2147	863
Forward Voltage (Vf)	11.78				12.36				12.85			
Current (mA)	350				700				1050			

CCT	3000K											
Wattage	4W				9W				14W			
Beam Angles	10°	20°	30°	50°	10°	20°	30°	50°	10°	20°	30°	50°
Luminaire Lumens (lm)	392	341	331	347	659	582	571	584	870	761	750	772
Circuit Watts (c/W)	5.9	5.9	5.8	6	10.6	10.6	10.5	10.5	15.9	15.8	15.6	15.7
Luminaire Efficacy (l/cW)	67	58	57	58	62	55	54	56	55	48	48	49
Luminance (Cd)	6048	1854	1172	455	10624	3176	1963	773	14137	4215	2582	1023
Forward Voltage (Vf)	11.78				12.36				12.85			
Current (mA)	350				700				1050			

Binning	2 step MacAdams											
CRI	90+											
TM-30-15	Rg 102 Rf 90											
Lumen Maintenance	LM80											
Lifetime	50,000 hours											
Dimming Options	Mains dim / Non-dim / 0-10V / DALI (dim to dark 0.01%) / Casambi											
Flicker Index	0											
SVM: (Visual Flicker)	0.02											
Driver distance from fitting	Up to 10m (AWG 20)*											
Wiring Type	Series											
Accessories	Remote emergency (Maintained / Self Test)											

\*If driver distance from fitting is +10m see driver configurator document for guidance

## LIGHT CONES

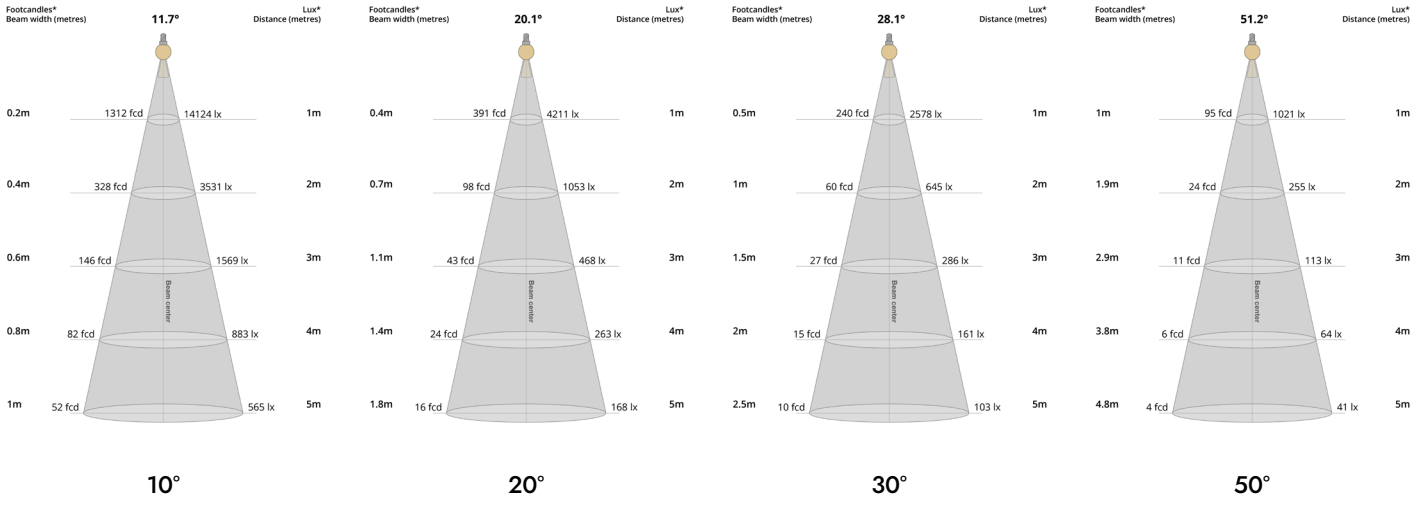

## POLAR CURVES

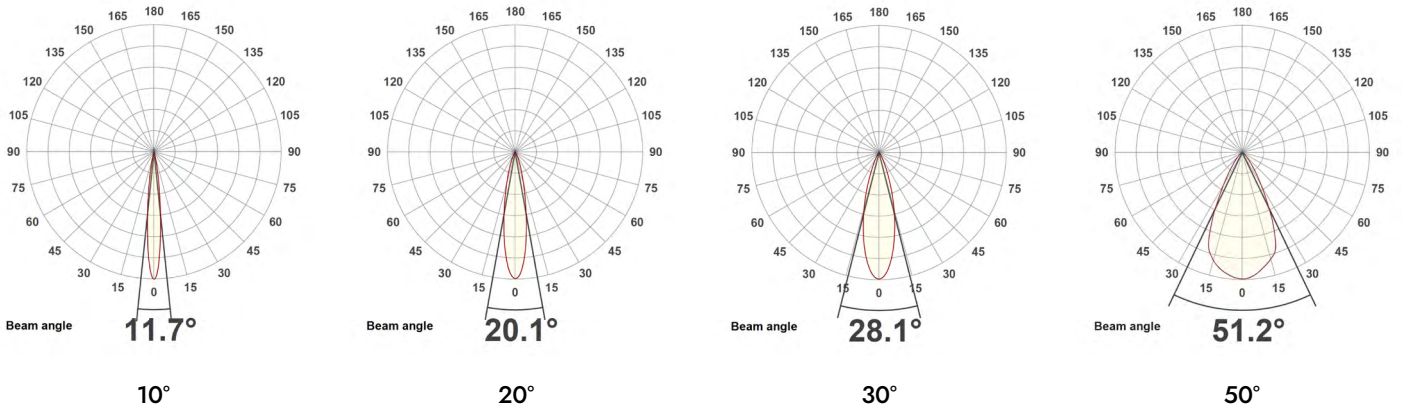

## PARTCODE BUILDER

Example Code: **OC-R-MT-WT/WT/WT/WT/WT-WT-STD4-27-90-20-350**

Family	Variet	Mount Finish	Arm Finish	Bezel Finish	Socket Finish	Body Finish	Inner Baffle Finish	Engine	Power	CCT	CRI	Beam Angle	Driver Current
<b>OC-R</b> Ocular Round	<b>MT</b> Mini Trim	<b>WT</b> White Textured	<b>WT</b> White Textured	<b>WT</b> White Textured	<b>WT</b> White Textured	<b>WT</b> White Textured	<b>WT</b> White Textured	<b>STD</b> Standard	<b>4</b> Watts	<b>27</b> 2700K	<b>90</b>	<b>10</b>	<b>350</b>
		<b>B1</b> Anodised Black	<b>B1</b> Anodised Black	<b>B1</b> Anodised Black	<b>B1</b> Anodised Black	<b>B1</b> Anodised Black	<b>B1</b> Anodised Black		<b>9</b> Watts	<b>30</b> 3000K		<b>20</b>	<b>700</b>
		<b>*C</b> Custom	<b>*C</b> Custom	<b>*C</b> Custom	<b>*C</b> Custom	<b>*C</b> Custom	<b>*C</b> Custom		<b>14</b> Watts	<b>40</b> 4000K		<b>30</b>	<b>1050</b>

\*Codes for custom finishes can be found on the page 6.

**ACCESSORIES** (multiple inserts available per fitting)



Commissioning Tool (Plastic)  
ACCS-TOOL-P-BAFFLE



SNOOT  
ACCS-SNOOT



Honeycomb Recessed  
ACCS-RECESSED-HCOMB



Honeycomb Flush  
ACCS-FLUSH-HCOMB



Softening Insert Recessed  
ACCS-RECESSED-SOFT



Softening Insert Flush  
ACCS-FLUSH-SOFT



Opal Insert Recessed  
ACCS-RECESSED-OPAL



Opal Insert Flush  
ACCS-FLUSH-OPAL



Elliptical Insert Recessed  
ACCS-RECESSED-10X60ELLIPTICAL



Elliptical Insert Flush  
ACCS-FLUSH-10X60ELLIPTICAL



Colour Change Insert Recessed  
ACCS-RECESSED-FILTER18K  
ACCS-RECESSED-FILTER22K  
ACCS-RECESSED-FILTER24K  
ACCS-RECESSED-FILTER25K



Colour Change Insert Flush  
ACCS-FLUSH-FILTER18K  
ACCS-FLUSH-FILTER22K  
ACCS-FLUSH-FILTER24K  
ACCS-FLUSH-FILTER25K

## FINISHES

Every element of your light can be finished in any of the options below:

### PLATED (Interior ONLY)



Antique Bronze  
01



Antique Brass  
02



Polished Chrome  
03



Satin Nickel  
04



Polished Copper  
05

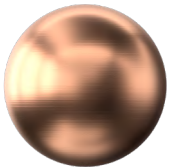

Satin Copper  
06



Polished Brass  
09

### ANODISED (Interior ONLY, except Orba Exteriors)



Tuba Brass  
11

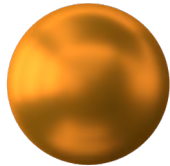

Antique Gold  
12



Espresso Bronze  
13



Cocoa Bronze  
14

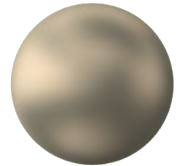

Ice Gold  
15



Mocha Bronze  
16



Taupe Bronze  
17



24K Gold  
18

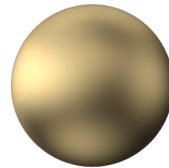

Champagne Gold  
19



Anodised Black (9005)  
B1

### POWDER COAT (Interior & Exterior)



Pure White (9010)  
W1



Textured White (9010)  
WT

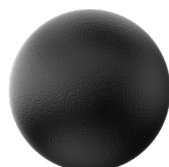

Textured Black (9005)  
BT



RAL Classic  
[www.phos.co.uk/finishes](http://www.phos.co.uk/finishes)



RAL Design  
price on application