



PHOS  
ENGINEERING LIGHT

ECLIPSE SQUARE  
STANDARD

## ECLIPSE SQUARE - STANDARD

The Eclipse Square is a recessed, tilt behind, adjustable downlight with an 80X80mm square bezel and features a beautifully sculpted anti-glare baffle inside a Ø38mm square aperture.

### PRODUCT FEATURES

- Downlight
- Adjustable
- Interior
- LED
- IP65
- Available in all Phos finishes
- Interchangeable optics (pre & post install)

### PHOS STANDARDS

- 60min fire-certified
- Acoustic-rated
- UK designed, manufactured and assembled
- 5 year warranty

### OPTICS

- Standard beam angles:  
10° / 20° / 30°
- Ellipsoidal accessories using:  
10° optic: 14.8° x 53.2°  
20° optic: 24.1° x 58.8°  
30° optic: 37.5° x 66.3°

### PHYSICAL PROPERTIES

- Diameter 80X80mm
- Height 76mm (4W/9W)
- Height 99mm (14W)
- Cut-out Ø72mm
- Tilt Max 26°

### PRODUCT VIEW



### DIMENSIONS

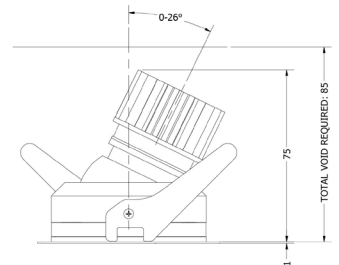
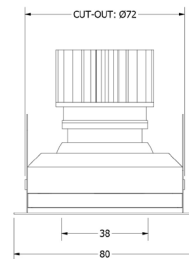

4W & 9W

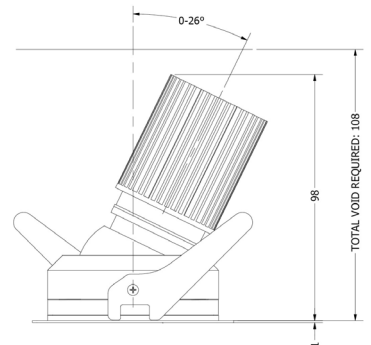
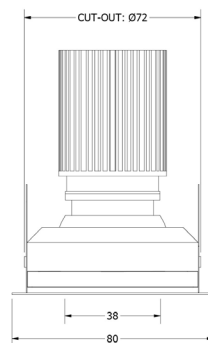

14W

## TECHNICAL SPECIFICATIONS (Preliminary testing data)

CCT	2700K								
	4W			9W			14W		
Beam Angles	10°	20°	30°	10°	20°	30°	10°	20°	30°
Luminaire Lumens (lm)	334	303	296	481	489	485	725	650	630
Circuit Watts (c/W)	5.9	6	5.9	10.5	10.5	10.5	15.5	15.5	15.5
Luminaire Efficacy (l/cW)	56	51	50	46	47	46	47	42	41
Luminaire (Cd)	6294	1521	888	8814	2507	1476	14516	3321	1969
Forward Voltage (Vf)	11.78			12.36			12.65		
Current (mA)	350			700			1050		

CCT	3000K								
	4W			9W			14W		
Beam Angles	10°	20°	30°	10°	20°	30°	10°	20°	30°
Luminaire Lumens (lm)	378	342	336	635	580	564	893	772	772
Circuit Watts (c/W)	5.9	5.9	5.9	10.6	10.5	10.6	15.8	15.7	15.7
Luminaire Efficacy (l/cW)	64	58	57	60	55	54	57	49	49
Luminaire (Cd)	3060	3048	3032	9895	2855	1745	14115	4027	2529
Forward Voltage (Vf)	11.78			12.36			12.65		
Current (mA)	350			700			1050		

Binning	2 step MacAdams
CRI	90+
TM-30-15	Rg 101 Rf 90
Lumen Maintenance	LM80
Lifetime	50,000 hours

Dimming Options	Mains dim / Non-dim / 0-10V / DALI (dim to dark 0.01%) / Casambi
Flicker Index	0
SVM: (Visual Flicker)	0.02

Driver distance from fitting	Up to 10m (AWG 20)*
Wiring Type	Series
Accessories	Remote emergency (Maintained / Self Test)

\*If driver distance from fitting is +10m see driver configurator document for guidance

## LIGHT CONES

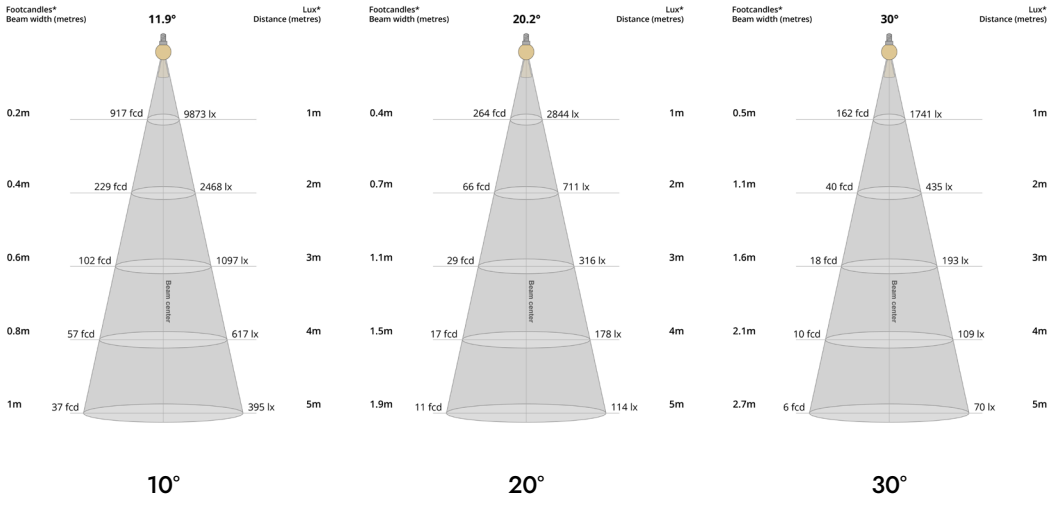

## POLAR CURVES

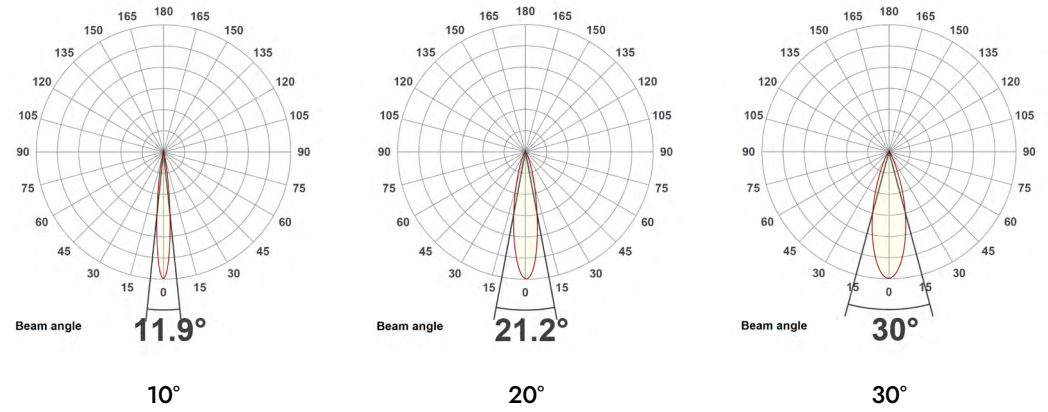

## PARTCODE BUILDER

Example Code: **EE-SQ-WT/B3/WT/WT-STD14-30-90-20-1050**

Family	Variant	Bezel Finish	Socket Finish	Outer Baffle Finish	Inner Baffle Finish	Engine	Power	CCT	CRI	Beam Angle	Driver Current		
EE Eclipse	SQ Square	WT White Textured	B3 Black	WT White Textured	WT White Textured	STD Standard	4 Watts	27 2700K	90	10	350		
		B1 Anodised Black					B1 Anodised Black	B1 Anodised Black		9 Watts	30 3000K	20	700
		*C Custom					*C Custom	*C Custom		14 Watts	40 4000K	30	1050

\*Codes for custom finishes can be found on the page 6.

**ACCESSORIES** (multiple inserts available per fitting)



Commissioning Tool (Plastic)  
ACCS-TOOL-P-BAFFLE



SNOOT  
ACCS-SNOOT



Honeycomb Recessed  
ACCS-RECESSED-HCOMB



Honeycomb Flush  
ACCS-FLUSH-HCOMB



Softening Insert Recessed  
ACCS-RECESSED-SOFT



Softening Insert Flush  
ACCS-FLUSH-SOFT



Opal Insert Recessed  
ACCS-RECESSED-OPAL



Opal Insert Flush  
ACCS-FLUSH-OPAL



Elliptical Insert Recessed  
ACCS-RECESSED-10X60ELLIPTICAL



Elliptical Insert Flush  
ACCS-FLUSH-10X60ELLIPTICAL



Colour Change Insert Recessed  
ACCS-RECESSED-FILTER18K  
ACCS-RECESSED-FILTER22K  
ACCS-RECESSED-FILTER24K  
ACCS-RECESSED-FILTER25K



Colour Change Insert Flush  
ACCS-FLUSH-FILTER18K  
ACCS-FLUSH-FILTER22K  
ACCS-FLUSH-FILTER24K  
ACCS-FLUSH-FILTER25K

## FINISHES

Every element of your light can be finished in any of the options below:

### PLATED (Interior ONLY)



Antique Bronze  
01



Antique Brass  
02



Polished Chrome  
03



Satin Nickel  
04



Polished Copper  
05

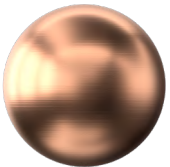

Satin Copper  
06



Polished Brass  
09

### ANODISED (Interior ONLY, except Orba Exteriors)



Tuba Brass  
11

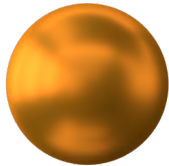

Antique Gold  
12



Espresso Bronze  
13



Cocoa Bronze  
14

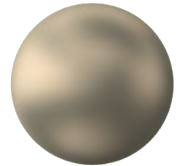

Ice Gold  
15



Mocha Bronze  
16



Taupe Bronze  
17



24K Gold  
18

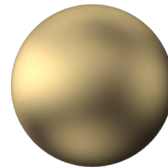

Champagne Gold  
19



Anodised Black (9005)  
B1

### POWDER COAT (Interior & Exterior)



Pure White (9010)  
W1



Textured White (9010)  
WT

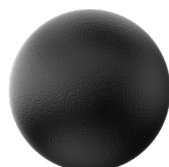

Textured Black (9005)  
BT



RAL Classic  
[www.phos.co.uk/finishes](http://www.phos.co.uk/finishes)



RAL Design  
price on application