



PHOS  
ENGINEERING LIGHT

ORBA WIRING HOUSING  
STANDARD

## ORBA WIRING HOUSING - STANDARD

With no visible fixings, the surface-mounted Wiring Housing enables the secondary wiring connections from a remote driver. The Puck is semi-recessed into the housing for a minimal appearance.

### PRODUCT FEATURES

Spotlight

Adjustable

Interior

LED

IP54

Available in all Phos finishes

Interchangeable optics & accessories (pre & post install)

### PHOS STANDARDS

60min fire-certified

Acoustic-rated

UK designed, manufactured and assembled

5 year warranty

### OPTICS

Standard beam angles:  
10° / 20° / 30° / 50°

Ellipsoidal accessories using:

10° optic: 14.8° x 53.2°

20° optic: 24.1° x 58.8°

30° optic: 37.5° x 66.3°

50° optic: 45.8° x 72.6°

### PHYSICAL PROPERTIES

Diameter  $\varnothing$ 70mm

Height 100mm

Tilt Max 210°

Rotation 360°

Cut-out  $\varnothing$ 10mm

### PRODUCT VIEW



### DIMENSIONS

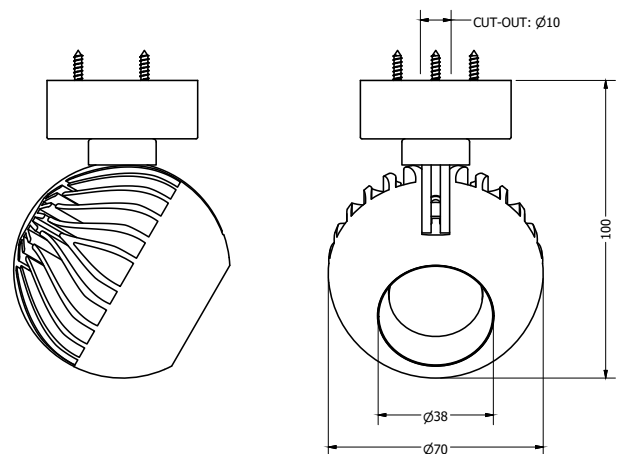

### DRIVER INFORMATION

[Driver Configurator \(Link\)](#)

## TECHNICAL SPECIFICATIONS

CCT	2700K											
Wattage	4W				9W				14W			
Beam Angles	10°	20°	30°	50°	10°	20°	30°	50°	10°	20°	30°	50°
Luminaire Lumens (lm)	344	300	301	311	580	489	505	519	698	631	634	663
Circuit Watts (c/W)	6	6	6	5.9	10.5	10.5	10.5	10.5	15.5	15.5	15.5	15.5
Luminaire Efficacy (l/cW)	57	50	50	53	55	47	48	49	45	41	41	43
Luminance (Cd)	5994	1679	1041	404	10350	2784	1791	678	12775	3544	2243	867
Forward Voltage (Vf)	11.78				12.36				12.65			
Current (mA)	350				700				1050			

CCT	3000K											
Wattage	4W				9W				14W			
Beam Angles	10°	20°	30°	50°	10°	20°	30°	50°	10°	20°	30°	50°
Luminaire Lumens (lm)	376	346	330	347	662	579	582	603	898	770	760	796
Circuit Watts (c/W)	5.9	5.9	5.8	5.8	10.5	10.5	10.5	10.7	15.8	15.7	15.7	15.7
Luminaire Efficacy (l/cW)	64	58	57	60	63	55	55	57	57	49	48	51
Luminance (Cd)	5297	1826	1164	457	9262	3100	2044	785	12586	4092	2667	1064
Forward Voltage (Vf)	11.78				12.36				12.65			
Current (mA)	350				700				1050			

Binning	2 step MacAdams											
CRI	90+											
TM-30-15	Rg 102 Rf 90											
Lumen Maintenance	LM80											
Lifetime	50,000 hours											
Dimming Options	Mains dim / Non-dim / 0-10V / DALI (dim to dark 0.01%) / Casambi											
Flicker Index	0											
SVM: (Visual Flicker)	0.02											
Driver distance from fitting	Up to 10m (AWG 20)*											
Wiring Type	Series											
Accessories	Remote emergency (Maintained / Self Test)											

\*If driver distance from fitting is +10m see driver configurator document for guidance

## LIGHT CONES

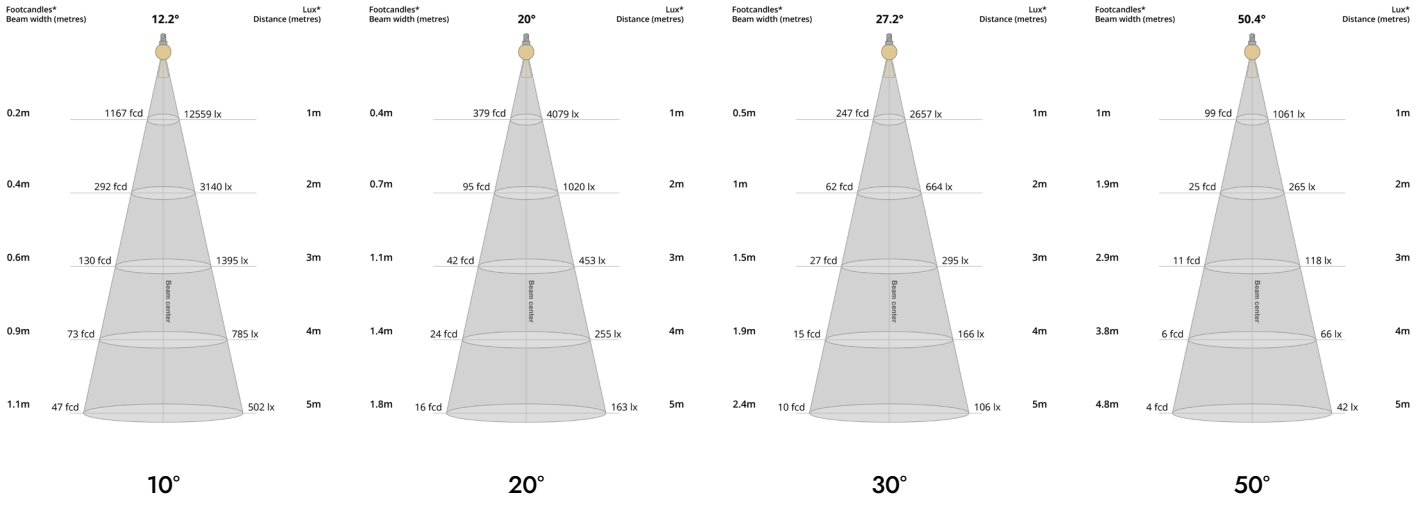

## POLAR CURVES

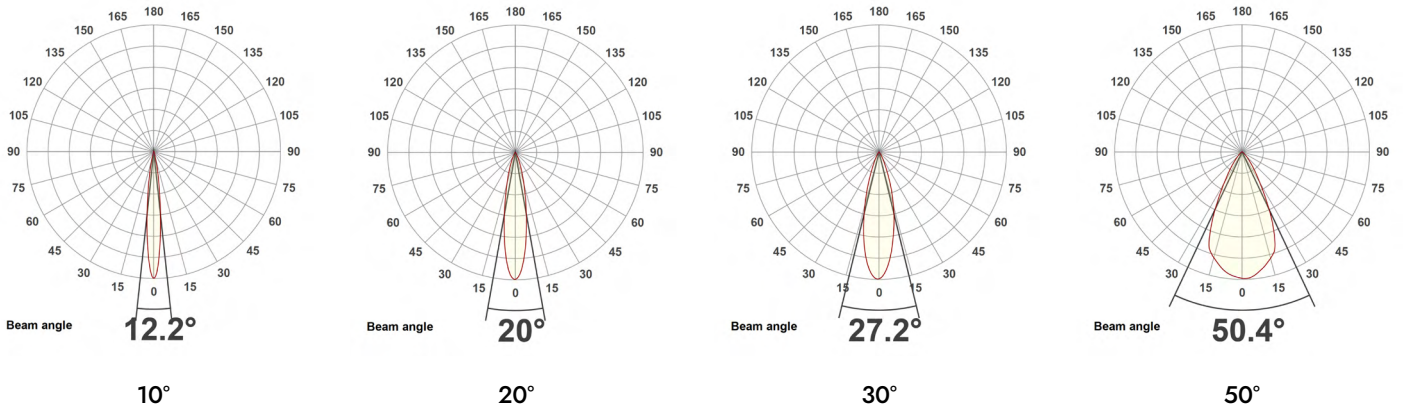

## PARTCODE BUILDER

Example Code: **OR-I-WH-WT/WT/WT-STD14-30-90-20-1050**

Family	Variant	Mount Finish	Body Finish	Inner Baffle Finish	Engine	Power	CCT	CRI	Beam Angle	Driver Current
OR Orba	I-WH Interior Wiring Housing	WT White Textured	WT White Textured	WT White Textured	STD Standard	4 Watts	27 2700K	90	10	350
		B1 Anodised Black	B1 Anodised Black	B1 Anodised Black		9 Watts	30 3000K		20	700
		*C Custom	*C Custom	*C Custom		14 Watts	40 4000K		30	1050
									50	

\*Codes for custom finishes can be found on the page 6.

## ACCESSORIES (multiple inserts available per fitting)



Commissioning Tool (Plastic)  
ACCS-TOOL-P-BAFFLE



SNOOT  
ACCS-SNOOT



Honeycomb Recessed  
ACCS-RECESSED-HCOMB



Honeycomb Flush  
ACCS-FLUSH-HCOMB



Softening Insert Recessed  
ACCS-RECESSED-SOFT



Softening Insert Flush  
ACCS-FLUSH-SOFT



Opal Insert Recessed  
ACCS-RECESSED-OPAL



Opal Insert Flush  
ACCS-FLUSH-OPAL



Elliptical Insert Recessed  
ACCS-RECESSED-10X60ELLIPTICAL



Elliptical Insert Flush  
ACCS-FLUSH-10X60ELLIPTICAL



Colour Change Insert Recessed  
ACCS-RECESSED-FILTER18K  
ACCS-RECESSED-FILTER22K  
ACCS-RECESSED-FILTER24K  
ACCS-RECESSED-FILTER25K



Colour Change Insert Flush  
ACCS-FLUSH-FILTER18K  
ACCS-FLUSH-FILTER22K  
ACCS-FLUSH-FILTER24K  
ACCS-FLUSH-FILTER25K



## FINISHES

Every element of your light can be finished in any of the options below, or RAL colour:

### PLATED



Antique Bronze  
01



Antique Brass  
02



Polished Chrome  
03



Satin Nickel  
04



Polished Copper  
05

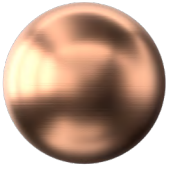

Satin Copper  
06



Polished Brass  
09

### ANODISED

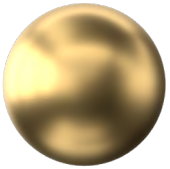

Tuba Brass  
11

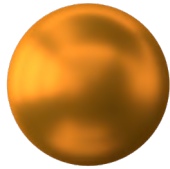

Antique Gold  
12



Espresso Bronze  
13



Cocoa Bronze  
14

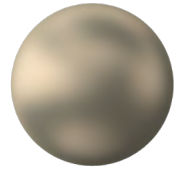

Ice Gold  
15



Mocha Bronze  
16



Taupe Bronze  
17



24K Gold  
18

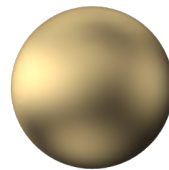

Champagne Gold  
19



Anodised Black (9005)  
B1

### POWDER COATED



Pure White (9010)  
W1



Textured White (9010)  
WT

### WET SPRAYED



Rust  
26



Verdigris  
27



Wet Bronze  
28