



PHOS
ENGINEERING LIGHT

ORBA SURFACE PLATE SPRING
STANDARD

ORBA SURFACE PLATE SPRING - STANDARD

A simple 3-screw hole mounting plate, with Puck, which then neatly covers the hole in the ceiling through which the remote driver can pass.

PRODUCT FEATURES

Spotlight

Adjustable

Interior

LED

IP54

Available in all Phos finishes

Interchangeable optics & accessories (pre & post install)

PHOS STANDARDS

60min fire-certified

Acoustic-rated

UK designed, manufactured and assembled

5 year warranty

OPTICS

Standard beam angles:

10° / 20° / 30° / 50°

Ellipsoidal accessories using:

10° optic: 14.8° x 53.2°

20° optic: 24.1° x 58.8°

30° optic: 37.5° x 66.3°

50° optic: 45.8° x 72.6°

PHYSICAL PROPERTIES

Diameter \varnothing 70mm

Height 80mm

Tilt Max 210°

Rotation 360°

Cut-out \varnothing 51mm

PRODUCT VIEW



DIMENSIONS

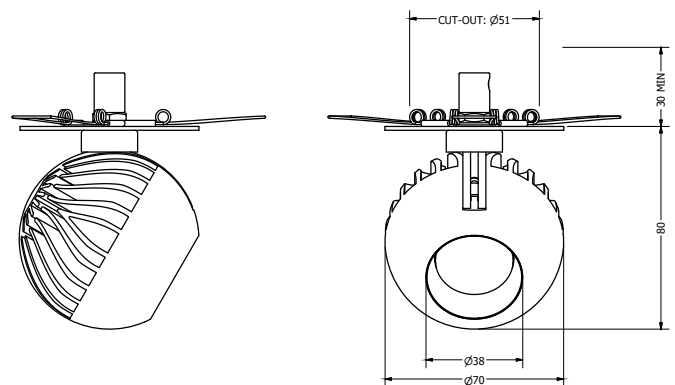

TECHNICAL SPECIFICATIONS

CCT	2700K											
Wattage	4W				9W				14W			
Beam Angles	10°	20°	30°	50°	10°	20°	30°	50°	10°	20°	30°	50°
Luminaire Lumens (lm)	344	300	301	311	580	489	505	519	698	631	634	663
Circuit Watts (c/W)	6	6	6	5.9	10.5	10.5	10.5	10.5	15.5	15.5	15.5	15.5
Luminaire Efficacy (l/cW)	57	50	50	53	55	47	48	49	45	41	41	43
Luminance (Cd)	5994	1679	1041	404	10350	2784	1791	678	12775	3544	2243	867
Forward Voltage (Vf)	11.78				12.36				12.65			
Current (mA)	350				700				1050			

CCT	3000K											
Wattage	4W				9W				14W			
Beam Angles	10°	20°	30°	50°	10°	20°	30°	50°	10°	20°	30°	50°
Luminaire Lumens (lm)	376	346	330	347	662	579	582	603	898	770	760	796
Circuit Watts (c/W)	5.9	5.9	5.8	5.8	10.5	10.5	10.5	10.7	15.8	15.7	15.7	15.7
Luminaire Efficacy (l/cW)	64	58	57	60	63	55	55	57	57	49	48	51
Luminance (Cd)	5297	1826	1164	457	9262	3100	2044	785	12586	4092	2667	1064
Forward Voltage (Vf)	11.78				12.36				12.65			
Current (mA)	350				700				1050			

Binning	2 step MacAdams											
CRI	90+											
TM-30-15	Rg 102 Rf 90											
Lumen Maintenance	LM80											
Lifetime	50,000 hours											
Dimming Options	Mains dim / Non-dim / 0-10V / DALI (dim to dark 0.01%) / Casambi											
Flicker Index	0											
SVM: (Visual Flicker)	0.02											
Driver distance from fitting	Up to 10m (AWG 20)*											
Wiring Type	Series											
Accessories	Remote emergency (Maintained / Self Test)											

*If driver distance from fitting is +10m see driver configurator document for guidance

LIGHT CONES

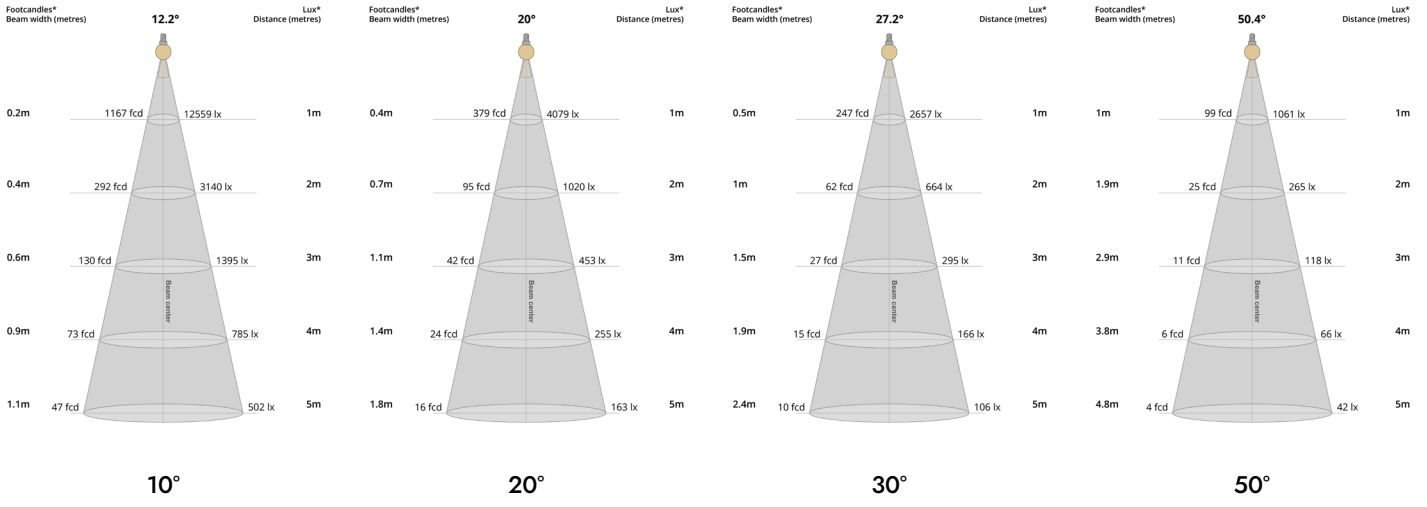

POLAR CURVES

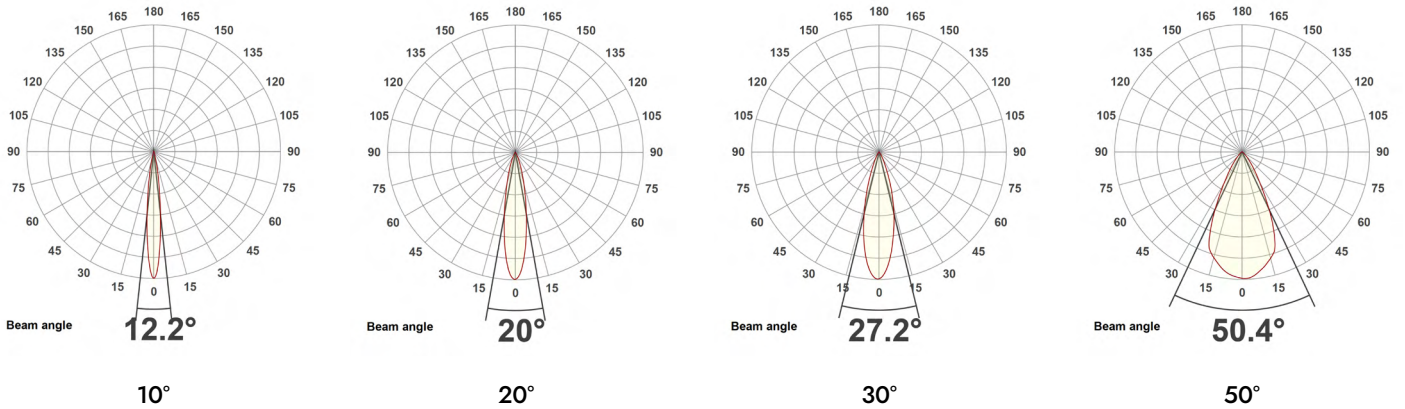

PARTCODE BUILDER

Example Code: **OR-I-SPS-WT/WT/WT-STD14-30-90-20-1050**

Family	Variant	Mount Finish	Body Finish	Inner Baffle Finish	Engine	Power	CCT	CRI	Beam Angle	Driver Current
OR Orba	I-SPS Interior Surface Plate Spring	WT White Textured	WT White Textured	WT White Textured	STD Standard	4 Watts	27 2700K	90	10	350
		B1 Anodised Black	B1 Anodised Black	B1 Anodised Black		9 Watts	30 3000K		20	700
		*C Custom	*C Custom	*C Custom		14 Watts	40 4000K		30	1050
									50	

*Codes for custom finishes can be found on the page 6.

ACCESSORIES (multiple inserts available per fitting)



Commissioning Tool (Plastic)
ACCS-TOOL-P-BAFFLE



SNOOT
ACCS-SNOOT



Honeycomb Recessed
ACCS-RECESSED-HCOMB



Honeycomb Flush
ACCS-FLUSH-HCOMB



Softening Insert Recessed
ACCS-RECESSED-SOFT



Softening Insert Flush
ACCS-FLUSH-SOFT



Opal Insert Recessed
ACCS-RECESSED-OPAL



Opal Insert Flush
ACCS-FLUSH-OPAL



Elliptical Insert Recessed
ACCS-RECESSED-10X60ELLIPTICAL



Elliptical Insert Flush
ACCS-FLUSH-10X60ELLIPTICAL



Colour Change Insert Recessed
ACCS-RECESSED-FILTER18K
ACCS-RECESSED-FILTER22K
ACCS-RECESSED-FILTER24K
ACCS-RECESSED-FILTER25K



Colour Change Insert Flush
ACCS-FLUSH-FILTER18K
ACCS-FLUSH-FILTER22K
ACCS-FLUSH-FILTER24K
ACCS-FLUSH-FILTER25K

FINISHES

Every element of your light can be finished in any of the options below, or RAL colour:

PLATED



Antique Bronze
01



Antique Brass
02



Polished Chrome
03



Satin Nickel
04



Polished Copper
05

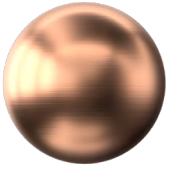

Satin Copper
06



Polished Brass
09

ANODISED

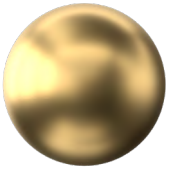

Tuba Brass
11

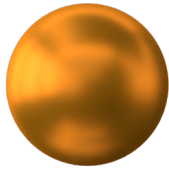

Antique Gold
12



Espresso Bronze
13



Cocoa Bronze
14



Ice Gold
15



Mocha Bronze
16



Taupe Bronze
17

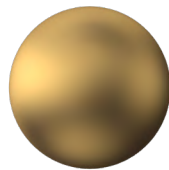

24K Gold
18

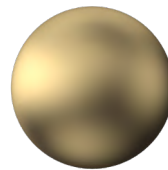

Champagne Gold
19



Anodised Black (9005)
B1

POWDER COATED



Pure White (9010)
W1



Textured White (9010)
WT

WET SPRAYED



Rust
26

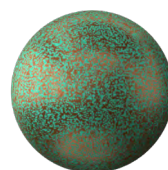

Verdigris
27



Wet Bronze
28