



PHOS
ENGINEERING LIGHT

ORBA EXTERIOR LAWN EDGE
STANDARD

ORBA EXTERIOR LAWN EDGE - STANDARD

A highly innovative approach to garden lighting! The mirror-polished stainless steel plate reflects the lawn in front and creates a “floating” effect. The Orba can then illuminate the planting, architectural features or trees. Available as either integral or remote gear versions.

PRODUCT FEATURES

Spotlight

Adjustable

Exterior

LED

IP65

Available in powder coated and anodised finishes

Interchangeable optics & accessories (pre & post install)

PHOS STANDARDS

60min fire-certified

Acoustic-rated

UK designed, manufactured and assembled

5 year warranty

OPTICS

Standard beam angles:
10°/ 20°/ 30°/ 50°

PHYSICAL PROPERTIES

Diameter \varnothing 120mm

Height 345mm

Tilt Max 210°

Rotation 360°

DRIVER INFORMATION

[Driver Configurator \(Link\)](#)

PRODUCT VIEW



DIMENSIONS

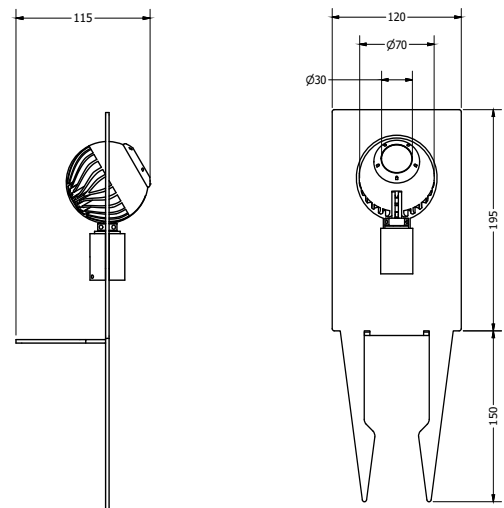

TECHNICAL SPECIFICATIONS

CCT	2700K											
Wattage	4W				9W				14W			
Beam Angles	10°	20°	30°	50°	10°	20°	30°	50°	10°	20°	30°	50°
Luminaire Lumens (lm)	268	229	247	190	438	471	408	323	582	438	528	410
Circuit Watts (c/W)	6	6	6	6.1	10.5	10.5	10.4	10.4	15.6	15.5	15.5	15.5
Luminaire Efficacy (l/cW)	45	38	41	31	42	35	39	31	37	28	34	26
Luminance (Cd)	4766	1366	972	334	7505	2286	1630	573	10371	2674	2063	742
Forward Voltage (Vf)	11.78				12.36				12.65			
Current (mA)	350				700				1050			

CCT	3000K											
Wattage	4W				9W				14W			
Beam Angles	10°	20°	30°	50°	10°	20°	30°	50°	10°	20°	30°	50°
Luminaire Lumens (lm)	296	206	278	216	529	440	462	375	652	505	615	494
Circuit Watts (c/W)	5.9	5.9	5.9	5.9	10.6	10.5	10.5	10.5	15.9	15.7	15.7	15.7
Luminaire Efficacy (l/cW)	50	35	47	37	50	42	44	36	41	32	39	32
Luminance (Cd)	3925	1234	1074	395	7774	2672	1838	671	8799	3150	2482	893
Forward Voltage (Vf)	11.78				12.36				12.65			
Current (mA)	350				700				1050			

Binning	2 step MacAdams
CRI	90+
TM-30-15	Rg 102 Rf 90
Lumen Maintenance	LM80
Lifetime	50,000 hours

Dimming Options	Mains dim / Non-dim / 0-10V / DALI (dim to dark 0.01%) / Casambi
Flicker Index	0
SVM: (Visual Flicker)	0.02

Driver distance from fitting	Up to 10m (AWG 20)*
Wiring Type	Series
Accessories	Remote emergency (Maintained / Self Test)

*If driver distance from fitting is +10m see driver configurator document for guidance

LIGHT CONES

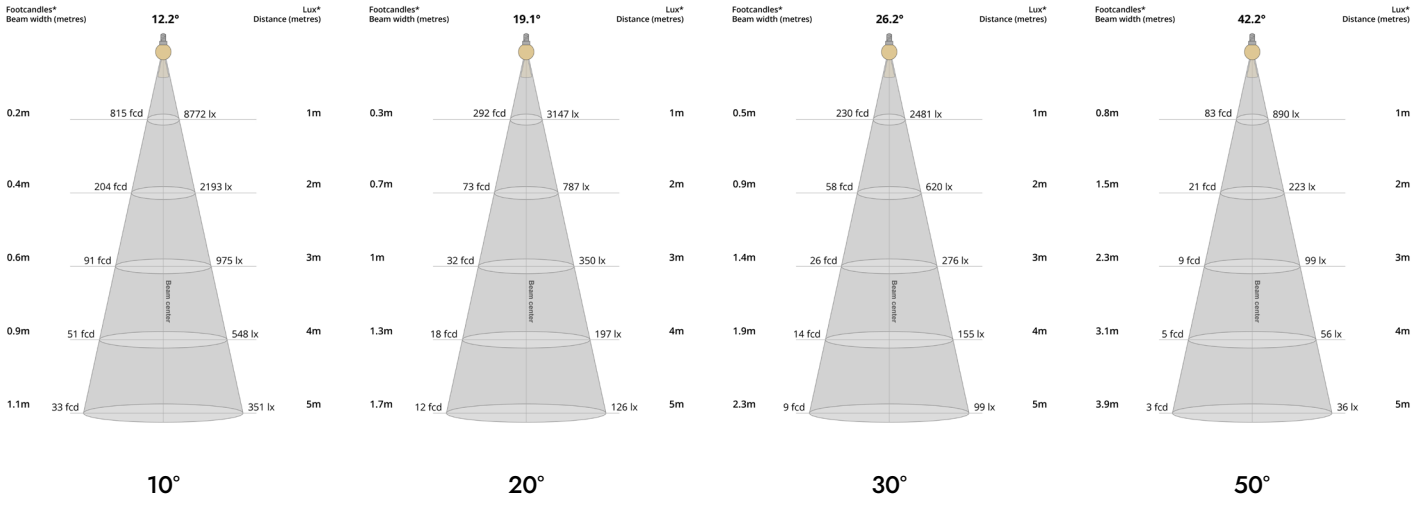

POLAR CURVES

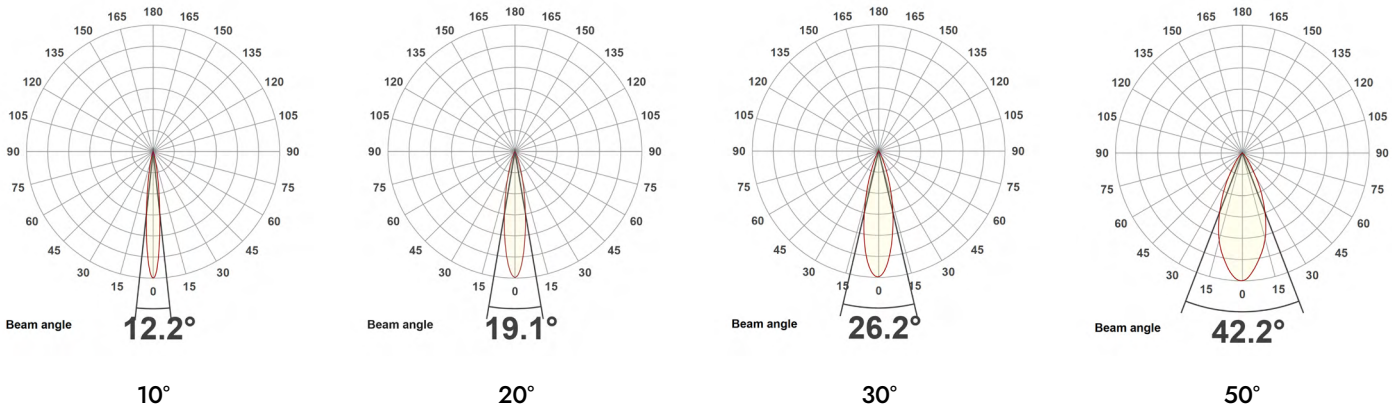

PARTCODE BUILDER

Example Code: **OR-E-LE-WT/WT/WT-STD14-30-90-20-1050**

Family	Variant	Mount Finish	Body Finish	Outer Baffle Finish	Engine	Power	CCT	CRI	Beam Angle	Driver Current
OR Orba	E-LE Exterior Lawn Edge	WT White Textured	WT White Textured	WT White Textured	STD Standard	4 Watts	27 2700K	90	10	350
		B1 Anodised Black	B1 Anodised Black	B1 Anodised Black		9 Watts	30 3000K		20	700
		*C Custom	*C Custom	*C Custom		14 Watts	40 4000K		30	1050
									50	

*Codes for custom finishes can be found on the next page.

FINISHES

Every element of your light can be finished in any of the options below, or RAL colour:

ANODISED

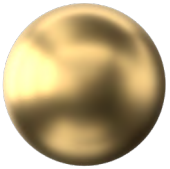

Tuba Brass
11

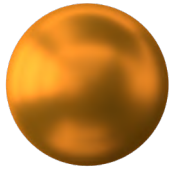

Antique Gold
12



Espresso Bronze
13



Cocoa Bronze
14



Ice Gold
15



Mocha Bronze
16



Taupe Bronze
17

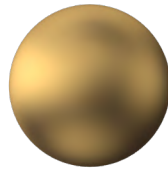

24K Gold
18

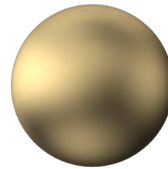

Champagne Gold
19



Anodised Black (9005)
B1

POWDER COATED



Pure White (9010)
W1



Textured White (9010)
WT

WET SPRAYED



Rust
26

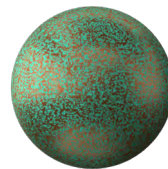

Verdigris
27



Wet Bronze
28