

PHOS  
ENGINEERING LIGHT

EYECONIC TWIN RECESSED  
ROUND ADJUSTABLE  
STANDARD

## EYECONIC TWIN RECESSED ROUND ADJUSTABLE - STANDARD

The Eyeconic Twin Recessed Round Adjustable is a recessed, directional downlight with a 60x120mm aperture and features a beautifully sculpted anti-glare baffle with a trimless plaster-in frame.

### PRODUCT FEATURES

- Downlight
- Adjustable
- Interior
- LED
- IP65
- Available in all Phos finishes
- Interchangeable optics & accessories (pre & post install)

### PHOS STANDARDS

- 60min fire-certified
- Acoustic-rated
- UK designed, manufactured and assembled
- 5 year warranty

### OPTICS

- Standard beam angles:  
10° / 20° / 30° / 50°
- Ellipsoidal accessories using:  
10° optic: 14.8° x 53.2°  
20° optic: 24.1° x 58.8°  
30° optic: 37.5° x 66.3°  
50° optic: 45.8° x 72.6°

### PHYSICAL PROPERTIES

- Height 81mm (4W/9W)
- Height 103mm (14W)
- Cut-out 72mm X 135mm

### DRIVER INFORMATION

[Driver Configurator \(Link\)](#)

### PRODUCT VIEW



### DIMENSIONS

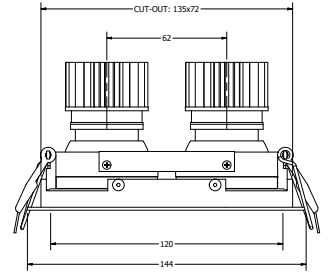
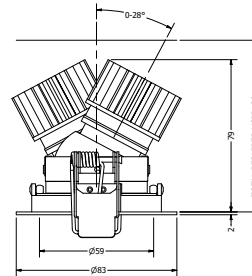

4W & 9W

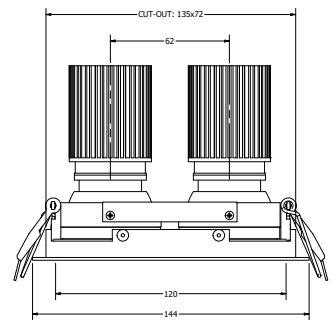
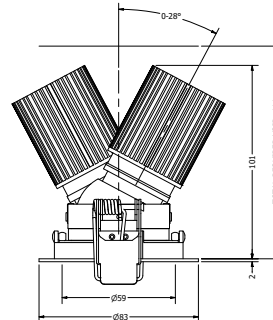

14W

## TECHNICAL SPECIFICATIONS

CCT	2700K											
	4W (x2)				9W (x2)				14W (x2)			
Wattage												
Beam Angles	10°	20°	30°	50°	10°	20°	30°	50°	10°	20°	30°	50°
Luminaire Lumens (lm)	348	303	296	310 (x2)	572	489	485	504 (x2)	732	650	630	669 (x2)
Circuit Watts (c/W)	6	6	5.9	5.9 (x2)	10.8	10.5	10.5	10.5 (x2)	16.2	15.5	15.5	15.5 (x2)
Luminaire Efficacy (l/cW)	58	51	50	52	53	47	46	48	45	42	41	43
Luminance (Cd)	5820	1521	888	381 (x2)	9592	2507	1476	632 (x2)	13460	3321	1969	832 (x2)
Forward Voltage (Vf)	11.78				12.36				12.65			
Current (mA)	350				700				1050			

CCT	3000K											
	4W (x2)				9W (x2)				14W (x2)			
Wattage												
Beam Angles	10°	20°	30°	50°	10°	20°	30°	50°	10°	20°	30°	50°
Luminaire Lumens (lm)	378	342	336	355 (x2)	635	580	564	597 (x2)	893	772	772	801 (x2)
Circuit Watts (c/W)	5.9	5.9	5.9	5.9 (x2)	10.6	10.5	10.6	10.5 (x2)	15.8	15.7	15.7	15.6 (x2)
Luminaire Efficacy (l/cW)	64	58	57	61	60	55	54	57	57	49	49	51
Luminance (Cd)	5827	1674	1018	442 (x2)	9895	2855	1745	753 (x2)	14115	4027	2529	1031 (x2)
Forward Voltage (Vf)	11.78				12.36				12.65			
Current (mA)	350				700				1050			

Binning	2 step MacAdams											
CRI	90+											
TM-30-15	Rg 101 Rf 90											
Lumen Maintenance	LM80											
Lifetime	50,000 hours											
Dimming Options	Mains dim / Non-dim / 0-10V / DALI (dim to dark 0.01%) / Casambi											
Flicker Index	0											
SVM: (Visual Flicker)	0.02											
Driver distance from fitting	Up to 10m (AWG 20)*											
Wiring Type	Series											
Accessories	Remote emergency (Maintained / Self Test)											

\*If driver distance from fitting is +10m see driver configurator document for guidance

## LIGHT CONES

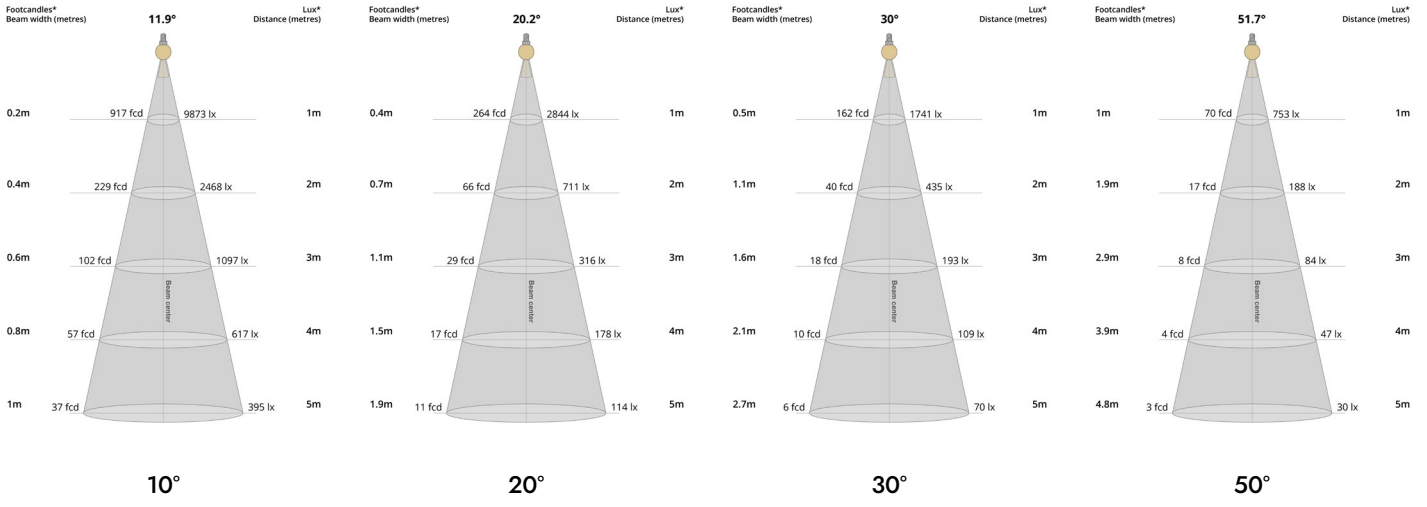

## POLAR CURVES

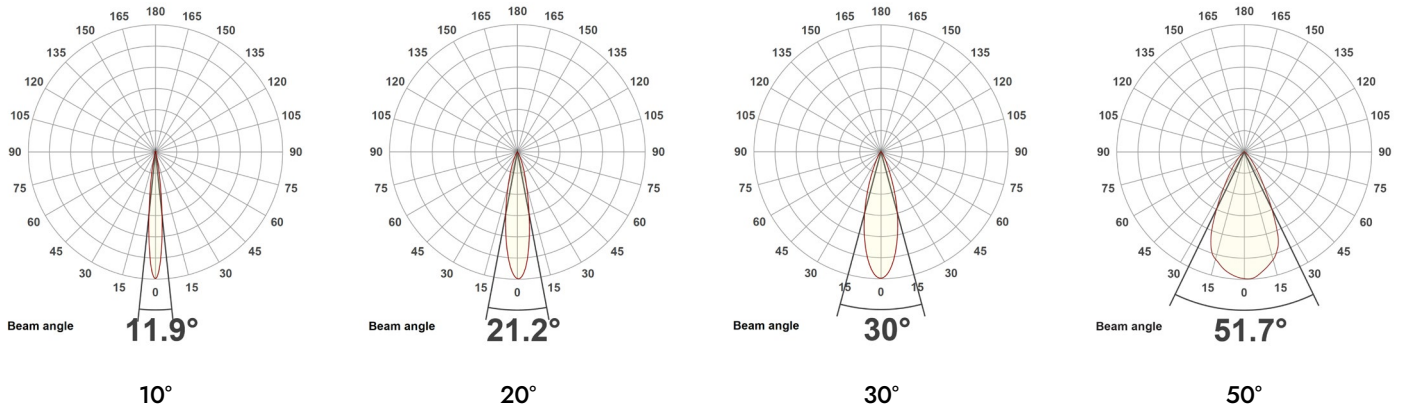

## PARTCODE BUILDER

Example Code: EY-RRQ2A-WT/WT/B1/WT/WT-STD14-30-90-20-1050

Family	Variant	Frame Finish	Bezel Finish	Socket Finish	Outer Baffle Finish	Inner Baffle Finish	Engine	Power	CCT	CRI	Beam Angle	Driver Current
EY Eyeconic	RRQ2A Twin Recessed Round Adjustable	WT White Textured	WT White Textured	B1 Anodised Black	WT White Textured	WT White Textured	STD Standard	4 Watts	27 2700K	90	10	350
		B1 Anodised Black	B1 Anodised Black	B1 Anodised Black	B1 Anodised Black	9 Watts		30 3000K	20		700	
		*C Custom	*C Custom	*C Custom	*C Custom	14 Watts		40 4000K	30		1050	
									50			

\*Codes for custom finishes can be found on the page 6.

**ACCESSORIES** (multiple inserts available per fitting)



Commissioning Tool (Plastic)  
ACCS-TOOL-P-BAFFLE



SNOOT  
ACCS-SNOOT



Honeycomb Recessed  
ACCS-RECESSED-HCOMB



Honeycomb Flush  
ACCS-FLUSH-HCOMB



Softening Insert Recessed  
ACCS-RECESSED-SOFT



Softening Insert Flush  
ACCS-FLUSH-SOFT



Opal Insert Recessed  
ACCS-RECESSED-OPAL



Opal Insert Flush  
ACCS-FLUSH-OPAL



Elliptical Insert Recessed  
ACCS-RECESSED-10X60ELLIPTICAL



Elliptical Insert Flush  
ACCS-FLUSH-10X60ELLIPTICAL



Colour Change Insert Recessed  
ACCS-RECESSED-FILTER18K  
ACCS-RECESSED-FILTER22K  
ACCS-RECESSED-FILTER24K  
ACCS-RECESSED-FILTER25K



Colour Change Insert Flush  
ACCS-FLUSH-FILTER18K  
ACCS-FLUSH-FILTER22K  
ACCS-FLUSH-FILTER24K  
ACCS-FLUSH-FILTER25K

## FINISHES

Every element of your light can be finished in any of the options below:

### PLATED (Interior ONLY)



Antique Bronze  
01



Antique Brass  
02



Polished Chrome  
03



Satin Nickel  
04



Polished Copper  
05

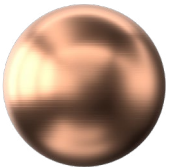

Satin Copper  
06



Polished Brass  
09

### ANODISED (Interior ONLY, except Orba Exteriors)



Tuba Brass  
11



Antique Gold  
12



Espresso Bronze  
13



Cocoa Bronze  
14



Ice Gold  
15



Mocha Bronze  
16



Taupe Bronze  
17

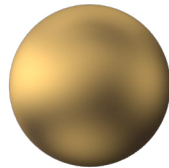

24K Gold  
18

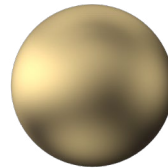

Champagne Gold  
19



Anodised Black (9005)  
B1

### POWDER COAT (Interior & Exterior)



Pure White (9010)  
W1



Textured White (9010)  
WT

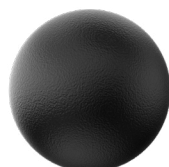

Textured Black (9005)  
BT



RAL Classic  
[www.phos.co.uk/finishes](http://www.phos.co.uk/finishes)



RAL Design  
price on application