

PHOS
ENGINEERING LIGHT

EYECONIC ROUND WALL WASH
STANDARD

EYECONIC ROUND WALL WASH - STANDARD

The Eyeconic Round Wall Wash is a recessed, fixed downlight with a 80mm bezel, wall wash lens and a discrete removeable anti-glare guard.

PRODUCT FEATURES

Downlight

Fixed

Interior

LED

IP65

Available in all Phos finishes

Interchangeable optics & accessories (pre & post install)

PHOS STANDARDS

60min fire-certified

Acoustic-rated

UK designed, manufactured and assembled

5 year warranty

OPTICS

Standard beam angles:
Wall Wash

PHYSICAL PROPERTIES

Diameter \varnothing 80mm

Height 73mm (4W/9W)

Height 98mm (14W)

Cut-out \varnothing 56mm

DRIVER INFORMATION

[Driver Configurator \(Link\)](#)

PRODUCT VIEW



DIMENSIONS

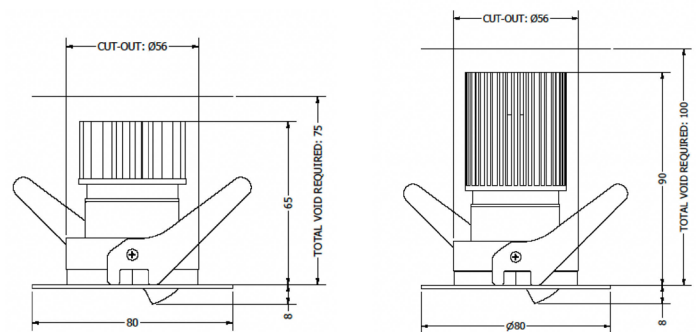

4W & 9W

14W

TECHNICAL SPECIFICATIONS

CCT	2700K		
Wattage	4W	9W	14W
Beam Angles	WW	WW	WW
Luminaire Lumens (lm)	125	211	262
Circuit Watts (c/W)	6	10.8	16.2
Luminaire Efficacy (l/cW)	21	20	16
Luminance (Cd)	147	243	309
Forward Voltage (Vf)	11.78	12.36	12.65
Current (mA)	350	700	1050

CCT	3000K		
Wattage	4W	9W	14W
Beam Angles	WW	WW	WW
Luminaire Lumens (lm)	131	232	302
Circuit Watts (c/W)	6	10.8	16.3
Luminaire Efficacy (l/cW)	22	21	18
Luminance (Cd)	155	268	354
Forward Voltage (Vf)	11.78	12.36	12.65
Current (mA)	350	700	1050

Binning	2 step MacAdams
CRI	90+
TM-30-15	Rg 101 Rf 90
Lumen Maintenance	LM80
Lifetime	50,000 hours

Dimming Options	Mains dim / Non-dim / 0-10V / DALI (dim to dark 0.01%) / Casambi
Flicker Index	0
SVM: (Visual Flicker)	0.02

Driver distance from fitting	Up to 10m (AWG 20)*
Wiring Type	Series
Accessories	Remote emergency (Maintained / Self Test)

*If driver distance from fitting is +10m see driver configurator document for guidance

LIGHT CONES

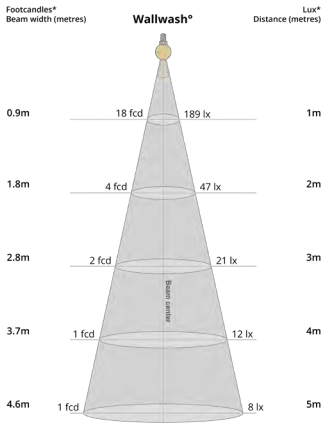

WW

POLAR CURVES

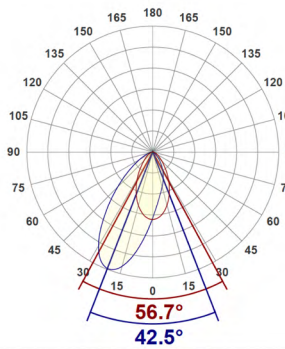

WW

PARTCODE BUILDER

Example Code: **EY-RW-WT/B1-STD14-30-90-WW-1050**

Family	Variant	Bezel Finish	Socket Finish	Engine	Power	CCT	CRI	Beam Angle	Driver Current
EY Eyeconic	RW Round Wall Wash	WT White Textured	B1 Anodised Black	STD Standard	4 Watts	27 2700K	90	WW	350
		B1 Anodised Black			9 Watts	30 3000K			700
		*C Custom			14 Watts				1050

*Codes for custom finishes can be found on the page 6.

FINISHES

Every element of your light can be finished in any of the options below:

PLATED (Interior ONLY)



Antique Bronze
01



Antique Brass
02



Polished Chrome
03



Satin Nickel
04



Polished Copper
05

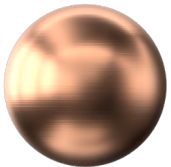

Satin Copper
06



Polished Brass
09

ANODISED (Interior ONLY, except Orba Exteriors)



Tuba Brass
11

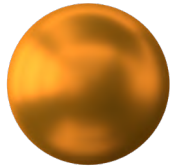

Antique Gold
12



Espresso Bronze
13



Cocoa Bronze
14

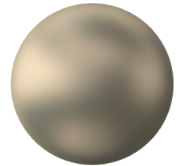

Ice Gold
15



Mocha Bronze
16



Taupe Bronze
17



24K Gold
18

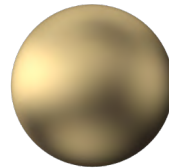

Champagne Gold
19



Anodised Black (9005)
B1

POWDER COAT (Interior & Exterior)



Pure White (9010)
W1



Textured White (9010)
WT

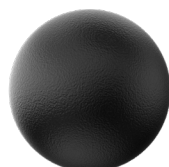

Textured Black (9005)
BT



RAL Classic
www.phos.co.uk/finishes



RAL Design
price on application