

PHOS
ENGINEERING LIGHT

EYECONIC RECESSED SQUARE ADJUSTABLE
STANDARD

EYECONIC RECESSED SQUARE ADJUSTABLE - STANDARD

The Eyeconic Recessed Square Adjustable is a recessed, directional downlight with a 80x80mm aperture and features a beautifully sculpted anti-glare baffle.

PRODUCT FEATURES

- Downlight
- Adjustable
- Interior
- LED
- IP65
- Available in all Phos finishes
- Interchangeable optics & accessories (pre & post install)

PHOS STANDARDS

- 60min fire-certified
- Acoustic-rated
- UK designed, manufactured and assembled
- 5 year warranty

OPTICS

- Standard beam angles:
10° / 20° / 30° / 50°
- Ellipsoidal accessories using:
10° optic: 14.8° x 53.2°
20° optic: 24.1° x 58.8°
30° optic: 37.5° x 66.3°
50° optic: 45.8° x 72.6°

PHYSICAL PROPERTIES

- Diameter \varnothing 62mm
- Height 70mm (4W/9W)
- Height 92mm (14W)
- Cut-out \varnothing 56mm

DRIVER INFORMATION

[Driver Configurator \(Link\)](#)

PRODUCT VIEW



DIMENSIONS

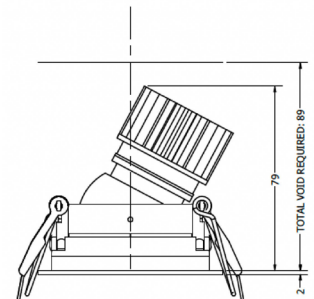
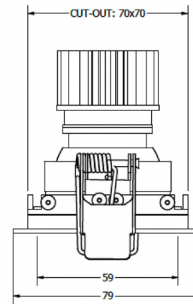

4W & 9W

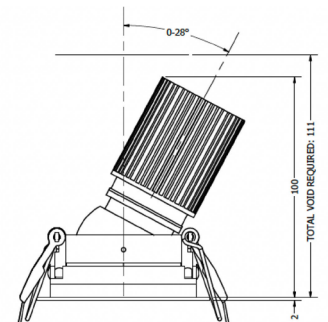
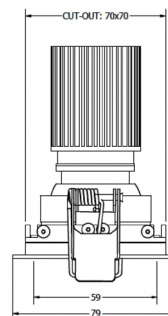

14W

TECHNICAL SPECIFICATIONS

CCT	2700K											
Wattage	4W				9W				14W			
Beam Angles	10°	20°	30°	50°	10°	20°	30°	50°	10°	20°	30°	50°
Luminaire Lumens (lm)	348	303	296	310	572	489	485	504	732	650	630	669
Circuit Watts (c/W)	6	6	5.9	5.9	10.8	10.5	10.5	10.5	16.2	15.5	15.5	15.5
Luminaire Efficacy (l/cW)	58	51	50	52	53	47	46	48	45	42	41	43
Luminance (Cd)	5820	1521	888	381	9592	2507	1476	632	13460	3321	1969	832
Forward Voltage (Vf)	11.78				12.36				12.65			
Current (mA)	350				700				1050			

CCT	3000K											
Wattage	4W				9W				14W			
Beam Angles	10°	20°	30°	50°	10°	20°	30°	50°	10°	20°	30°	50°
Luminaire Lumens (lm)	378	342	336	355	635	580	564	597	893	772	772	801
Circuit Watts (c/W)	5.9	5.9	5.9	5.9	10.6	10.5	10.6	10.5	15.8	15.7	15.7	15.6
Luminaire Efficacy (l/cW)	64	58	57	61	60	55	54	57	57	49	49	51
Luminance (Cd)	5827	1674	1018	442	9895	2855	1745	753	14115	4027	2529	1031
Forward Voltage (Vf)	11.78				12.36				12.65			
Current (mA)	350				700				1050			

Binning	2 step MacAdams											
CRI	90+											
TM-30-15	Rg 101 Rf 90											
Lumen Maintenance	LM80											
Lifetime	50,000 hours											
Dimming Options	Mains dim / Non-dim / 0-10V / DALI (dim to dark 0.01%) / Casambi											
Flicker Index	0											
SVM: (Visual Flicker)	0.02											
Driver distance from fitting	Up to 10m (AWG 20)*											
Wiring Type	Series											
Accessories	Remote emergency (Maintained / Self Test)											

*If driver distance from fitting is +10m see driver configurator document for guidance

LIGHT CONES

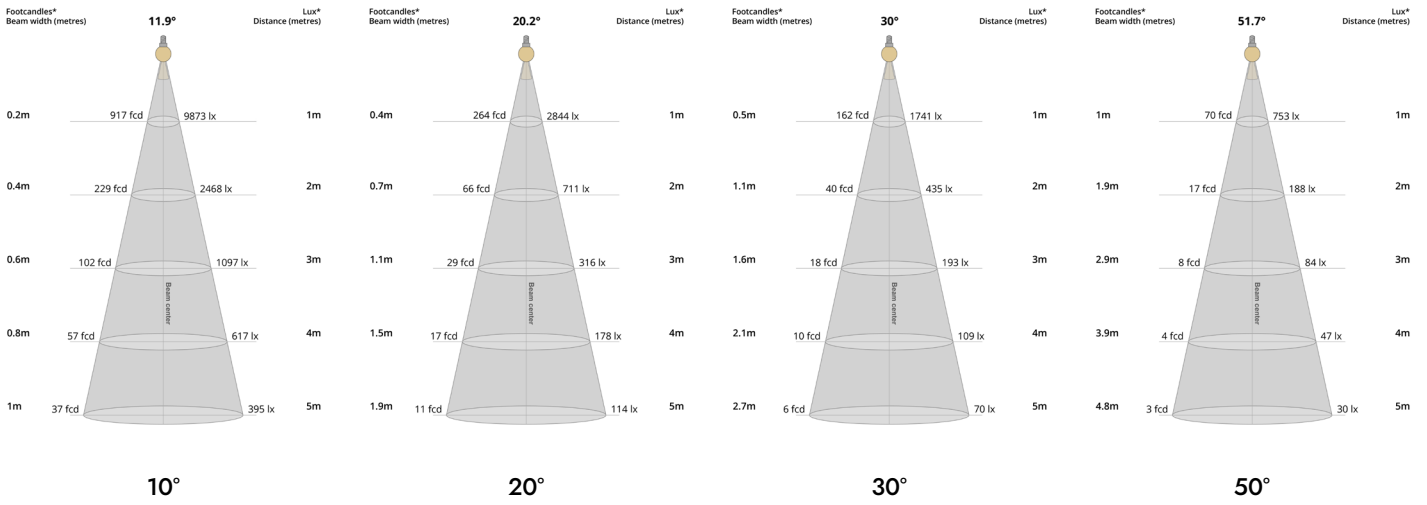

POLAR CURVES

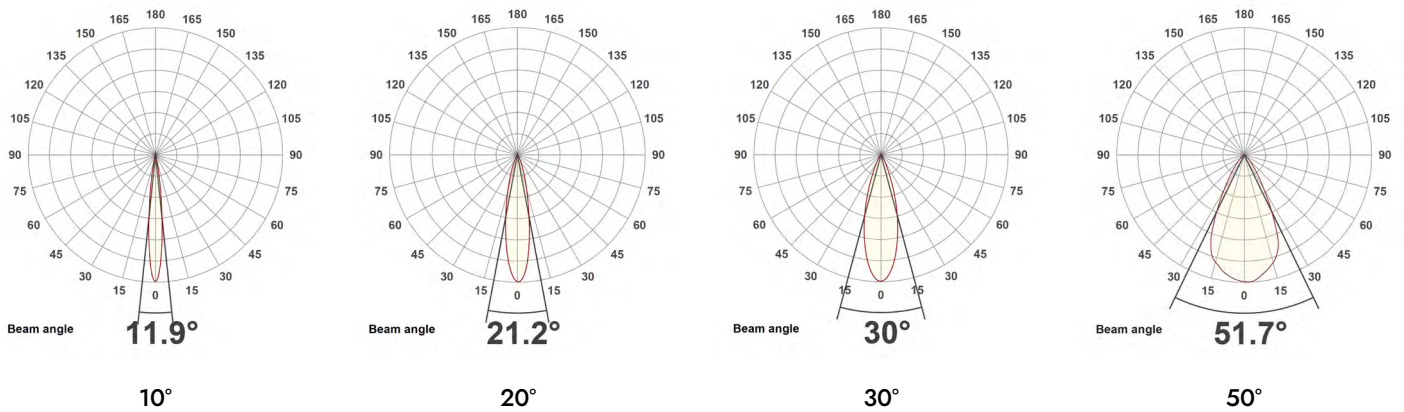

PARTCODE BUILDER

Example Code: EY-RSQA-WT/WT/B1/WT/WT-STD14-30-90-20-1050

Family	Variant	Frame Finish	Bezel Finish	Socket Finish	Outer Baffle Finish	Inner Baffle Finish	Engine	Power	CCT	CRI	Beam Angle	Driver Current
EY Eyeconic	RSQA Recessed Square Adjustable	WT White Textured	WT White Textured	B1 Anodised Black	WT White Textured	WT White Textured	STD Standard	4 Watts	27 2700K	90	10	350
		B1 Anodised Black	B1 Anodised Black	B1 Anodised Black	B1 Anodised Black	9 Watts		30 3000K	20		700	
		*C Custom	*C Custom	*C Custom	*C Custom	14 Watts		40 4000K	30		1050	
											50	

*Codes for custom finishes can be found on the page 6.

ACCESSORIES (multiple inserts available per fitting)



Commissioning Tool (Plastic)
ACCS-TOOL-P-BAFFLE



SNOOT
ACCS-SNOOT



Honeycomb Recessed
ACCS-RECESSED-HCOMB



Honeycomb Flush
ACCS-FLUSH-HCOMB



Softening Insert Recessed
ACCS-RECESSED-SOFT



Softening Insert Flush
ACCS-FLUSH-SOFT



Opal Insert Recessed
ACCS-RECESSED-OPAL



Opal Insert Flush
ACCS-FLUSH-OPAL



Elliptical Insert Recessed
ACCS-RECESSED-10X60ELLIPTICAL



Elliptical Insert Flush
ACCS-FLUSH-10X60ELLIPTICAL



Colour Change Insert Recessed
ACCS-RECESSED-FILTER18K
ACCS-RECESSED-FILTER22K
ACCS-RECESSED-FILTER24K
ACCS-RECESSED-FILTER25K



Colour Change Insert Flush
ACCS-FLUSH-FILTER18K
ACCS-FLUSH-FILTER22K
ACCS-FLUSH-FILTER24K
ACCS-FLUSH-FILTER25K

FINISHES

Every element of your light can be finished in any of the options below:

PLATED (Interior ONLY)



Antique Bronze
01



Antique Brass
02



Polished Chrome
03



Satin Nickel
04



Polished Copper
05

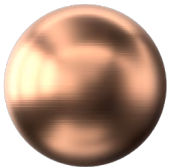

Satin Copper
06



Polished Brass
09

ANODISED (Interior ONLY, except Orba Exteriors)

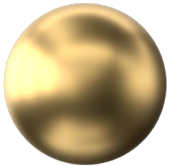

Tuba Brass
11

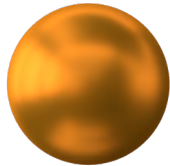

Antique Gold
12



Espresso Bronze
13



Cocoa Bronze
14

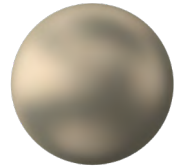

Ice Gold
15



Mocha Bronze
16



Taupe Bronze
17



24K Gold
18

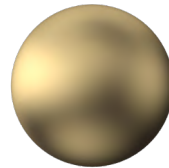

Champagne Gold
19



Anodised Black (9005)
B1

POWDER COAT (Interior & Exterior)



Pure White (9010)
W1



Textured White (9010)
WT

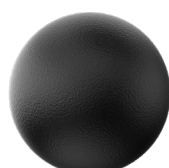

Textured Black (9005)
BT



RAL Classic
www.phos.co.uk/finishes



RAL Design
price on application